

VENDOR CONTRACT

Between _____ and
(Company Name)

THE INTERLOCAL PURCHASING SYSTEM (TIPS)

For

Sports Facility Lighting
CONTRACT NUMBER 7022516

General Information

The vendor contract shall include the contract, the terms and conditions, special terms and conditions, any agreed upon amendments, as well as all of the sections of the solicitation and the awarded vendor's proposal. Once signed, if an awarded vendor's proposal varies or is unclear in any way from the TIPS contract, TIPS, at its sole discretion, will decide which provision will prevail. Other documents to be included are the awarded vendor's proposals, task orders, purchase orders and any adjustments which have been issued.

The following pages will constitute the contract between the successful vendors(s) and TIPS. Bidders shall state, in a separate writing, and include with their proposal response, any required exceptions or deviations from these terms, conditions, and specifications. If agreed to by TIPS, they will be incorporated into the final contract.

The Vendor Contract ("Contract") made and entered into by and between The Interlocal Purchasing System (hereinafter referred to as "TIPS" respectfully) a government cooperative purchasing program authorized by the Region VIII Education Service Center, having its principal place of business at 4845 US Hwy 271 North, Pittsburg, Texas 75686. This contract consists of the provisions set forth below, including provisions of all Attachments referenced herein. In the event of a conflict between the provisions set forth below and those contained in any Attachment, the provisions set forth shall control.

Definitions

PURCHASE ORDER is the TIPS member's approval providing the authority to proceed with the negotiated delivery order under the contract. Special terms and conditions as agreed to between the vendor and TIPS member will be added as addendums to the PO. Items such as certificate of insurance, bonding requirements, small or disadvantaged business goals are some of the addendums possible.

PREMIUM HOURS are defined as those hours not included in regular hours or recognized holidays. Premium hours are to be approved by the TIPS member for each delivery order and noted in the delivery order proposal as a line item during negotiations.

REGULAR HOURS are defined as those hours between the hours of 7 AM and 6 PM Monday thru Friday.

Terms and Conditions

Freight

All deliveries shall be freight prepaid, F.O.B. destination and shall be included in all pricing offered unless otherwise clearly stated in writing.

Warranty Conditions

All supplies equipment and services shall include manufacturer's minimum standard warranty unless otherwise agreed to in writing. Vendor shall be an authorized dealer, distributor or manufacturer for all products. All equipment proposed shall be new unless clearly stated in writing.

Customer Support

The Vendor shall provide timely and accurate customer support to TIPS members. Vendors shall respond to such requests within one (1) working day after receipt of the request. Vendor shall provide training regarding products and services supplied by the Vendor unless otherwise clearly stated in writing at the time of purchase. (Unless training is a line item sold or packaged and must be purchased with product.)

Contracts

All contracts and agreements between Vendors and TIPS Members shall strictly adhere to the statutes that are set forth in the Uniform Commercial Code as most recently revised.

Contracts for purchase will normally be put into effect by means of a purchase order(s) executed by authorized agents of the participating government entities.

Davis Bacon Act requirements will be met when Federal Funds are used for construction and/or repair of buildings.

Tax exempt status

A taxable item sold, leased, rented to, stored, used, or consumed by any of the following governmental entities is exempted from the taxes imposed by this chapter:(1) the United States; (2) an unincorporated instrumentality of the United States; (3) a corporation that is an agency or instrumentality of the United States and is wholly owned by the United States or by another corporation wholly owned by the United States;(4) the State of Texas; (5) a Texas county, city, special district, or other political subdivision; or (6) a state, or a governmental unit of a state that borders Texas, but only to the extent that the other state or governmental unit

exempts or does not impose a tax on similar sales of items to this state or a political subdivision of this state. Texas Tax Code § 151.309.

Assignments of contracts

No assignment of contract may be made without the prior written approval of TIPS. Payment can only be made to the awarded Vendor or vendor assigned dealer.

Disclosures

1. Vendor affirms that he/she has not given, offered to give, nor intends to give at any time hereafter any economic opportunity, future employment, gift, loan, gratuity, special discount, trip, favor or service to a public servant in connection with this contract.
2. Vendor shall attach, in writing, a complete description of any and all relationships that might be considered a conflict of interest in doing business with participants in the TIPS program.
3. The vendor affirms that, to the best of his/her knowledge, the offer has been arrived at independently, and is submitted without collusion with anyone to obtain information or gain any favoritism that would in any way limit competition or give an unfair advantage over other vendors in the award of this contract.

Renewal of Contracts

The contract is for one (1) year with an option for renewal for 2 consecutive years. Total term of contract can be up to 3 years if sales are reported through the contract and both parties agree.

Shipments

The Vendor shall ship ordered products within five (5) working days after the receipt of the order. If a product cannot be shipped within that time, the Vendor shall notify TIPS and the requesting entity as to why the product has not shipped and shall provide an estimated shipping date, if applicable. TIPS or the requesting entity may cancel the order if estimated shipping time is not acceptable.

Invoices

The Vendor or vendor assigned dealer shall submit invoices, to the TIPS participant. Each invoice shall include the TIPS participant's purchase order number. The shipment tracking number or pertinent information for verification of TIPS participant receipt shall be made available upon request. The Vendor or vendor assigned dealer shall not invoice for partial shipments unless agreed to in writing in advance by TIPS and the TIPS participant.

Payments

The TIPS participant will make payments directly to the Vendor or vendor assigned dealer at net 30 days after receiving invoice.

Pricing

The Vendor contracts to provide pricing to TIPS and its participating governmental entities that is the lowest pricing available to like cooperative purchasing customers and the pricing shall remain so throughout the duration of the contract.

The Vendor agrees to promptly lower the cost of any product purchased through TIPS following a reduction in the manufacturer or publisher's direct cost to the Vendor. Price increases will be honored. However, the Vendor shall honor previous prices for thirty (30) days after written notification to TIPS of an increase.

All pricing submitted to TIPS shall include the participation fee to be remitted to TIPS by the Vendor. Vendor will not show adding the fee to the invoice presented to customer. The normal fee is 2%, but can be negotiated with the Vendor.

Participation Fees

Vendor or vendor assigned dealer contracts to pay the participation fee for all contract sales to TIPS on a monthly scheduled report. Vendor must login to the TIPS database and use the "Submission Report" section to report sales. The Vendor or vendor assigned dealers are responsible for keeping record of all sales that go through the TIPS contract. Failure to pay the participation fee will result in termination of contract. Please contact TIPS at tips@tips-usa.com or call (866) 839-8477 if you have questions about paying fees.

Indemnity

- 1. Indemnity for Personality Contracts.** Vendor agrees to indemnify and hold harmless and defend TIPS, TIPS member(s), officers and employees, from and against all claims and suits for damages, injuries to persons (including death), property damages, losses, and expenses including court costs and attorney's fees, arising out of, or resulting from, Vendor's performance of this contract, including all such causes of action based upon common, constitutional, or statutory law, or based in whole or in part, upon allegations of negligent or intentional acts on the part of the Vendor, its officers, employees, agents, subcontractors, licensees, invitees, whether or not such claims are based in whole or in part upon the negligent acts or omissions of the TIPS, TIPS member(s), officers, employees, or agents.
- 2. Indemnity for Performance Contracts.** The Vendor agrees to indemnify and hold harmless and defend TIPS, TIPS member(s), officers and employees from and against all claims and suits for damages, injuries to persons (including death), property damages, losses, and expenses including court costs and attorney's fees, arising out of, or resulting from, Vendor's work under this contract, including all such causes of action based upon common, constitutional, or statutory law, or based in whole or in part, upon allegations of negligent or intentional acts on the part of the Vendor, its officers, employees, agents, subcontractors, licensees, or invitees. Vendor further agrees to indemnify and

hold harmless and defend TIPS, TIPS member(s), officers and employees, from and against all claims and suits for injuries (including death) to an officer, employee, agent, subcontractor, supplier or equipment lessee of the Vendor, arising out of, or resulting from, Vendor's work under this contract whether or not such claims are based in whole or in part upon the negligent acts or omissions of the TIPS, TIPS member(s), officers, employees, or agents.

Attorney's Fees--Texas Local Government Code § 271.159 is expressly referenced.

Pursuant to §271.159, TEXAS LOC. GOV'T CODE, in the event that any one of the Parties is required to obtain the services of an attorney to enforce this Agreement, the prevailing party, in addition to other remedies available, shall be entitled to recover reasonable attorney's fees and costs of court.

Multiple Vendor Awards

TIPS reserves the right to award multiple vendor contracts for categories when deemed in the best interest of the TIPS membership. Bidders scoring 80% or above will be considered for an award. Categories are established at the discretion of TIPS.

State of Texas Franchise Tax

By signature hereon, the bidder hereby certifies that he/she is not currently delinquent in the payment of any franchise taxes owed the State of Texas under Chapter 171, Tax Code.

Miscellaneous

The Vendor acknowledges and agrees that continued participation in TIPS is subject to TIPS sole discretion and that any Vendor may be removed from the participation in the Program at any time with or without cause. Nothing in the contract or in any other communication between TIPS and the Vendor may be construed as a guarantee that TIPS participants will submit any orders at any time. TIPS reserves the right to request additional proposals for items already on contract at any time.

Purchase Order Pricing/Product Deviation

If a deviation of pricing/product on a purchase order occurs, TIPS is to be notified within 24 hours of receipt of order.

Cancellation for non-performance or contract deficiency

TIPS may terminate any contract if TIPS Members have not used the contract, or if purchase volume is determined to be "low volume" in any 12-month period. TIPS reserves the right to cancel the whole or any part of this contract due to failure by awarded vendor to carry out any obligation, term or condition of the contract. TIPS may issue a written deficiency notice to awarded vendor for acting or failing to act in any of the following:

- Providing material that does not meet the specifications of the contract;

- Providing work and/or material that was not awarded under the contract;
- Failing to adequately perform the services set forth in the scope of work and specifications;
- Failing to complete required work or furnish required materials within a reasonable amount of time;
- Failing to make progress in performance of the contract and/or giving TIPS reason to believe that awarded vendor will not or cannot perform the requirements of the contract; and/or
- Performing work or providing services under the contract prior to receiving a TIPS reviewed purchase order for such work.

Upon receipt of the written deficiency, awarded vendor shall have ten (10) days to provide a satisfactory response to TIPS. Failure to adequately address all issues of concern may result in contract cancellation. Upon cancellation under this paragraph, all goods, materials, work, documents, data and reports prepared by awarded vendor under this contract shall become the property of the TIPS Member on demand.

TIPS Member Purchasing Procedures

Purchase orders are issued by participating TIPS member to the awarded vendor indicating on the PO "Contract Number". Purchase Order is emailed to TIPS at tipspo@tips-usa.com.

- Awarded vendor delivers goods/services directly to the participating member.
- Awarded vendor invoices the participating TIPS member directly.
- Awarded vendor receives payment directly from the participating member.
- Awarded vendor reports sales monthly to TIPS (unless prior arrangements have been made with TIPS to report monthly).

Form of Contract

The form of contract for this solicitation shall be the Request for Proposal, the awarded proposal(s) and best and final offer(s), and properly issued and reviewed purchase orders referencing the requirements of the Request for Proposals. If a vendor submitting an offer requires TIPS and/or TIPS Member to sign an additional agreement, a copy of the proposed agreement must be included with the proposal.

Vendor contract documents: TIPS will review proposed vendor contract documents. Vendor's contract document shall not become part of TIPS's contract with vendor unless and until an authorized representative of TIPS reviews and approves it.

Licenses

Awarded vendor shall maintain in current status all federal, state and local licenses, bonds and permits required for the operation of the business conducted by awarded vendor. Awarded vendor shall remain fully informed of and in compliance with all ordinances and regulations pertaining to the lawful provision of services under the contract. TIPS reserves the right to stop

work and/or cancel contract of any awarded vendor whose license(s) expire, lapse, are suspended or terminated.

Novation

If awarded vendor sells or transfers all assets or the entire portion of the assets used to perform this contract, a successor in interest must guarantee to perform all obligations under this contract. TIPS reserves the right to accept or reject any new party. A simple change of name agreement will not change the contractual obligations of awarded vendor.

Site Requirements (when applicable to service or job)

Cleanup: Awarded vendor shall clean up and remove all debris and rubbish resulting from their work as required or directed by TIPS Member. Upon completion of work, the premises shall be left in good repair and an orderly, neat, clean and unobstructed condition.

Preparation: Awarded vendor shall not begin a project for which TIPS Member has not prepared the site, unless awarded vendor does the preparation work at no cost, or until TIPS Member includes the cost of site preparation in a purchase order.

Site preparation includes, but is not limited to: moving furniture, installing wiring for networks or power, and similar pre-installation requirements.

Registered sex offender restrictions: For work to be performed at schools, awarded vendor agrees that no employee of a sub-contractor who has been adjudicated to be a registered sex offender will perform work at any time when students are or reasonably expected to be present. Awarded vendor agrees that a violation of this condition shall be considered a material breach and may result in the cancellation of the purchase order at the TIPS Member's discretion.

Awarded vendor must identify any additional costs associated with compliance of this term. If no costs are specified, compliance with this term will be provided at no additional charge.

Safety measures: Awarded vendor shall take all reasonable precautions for the safety of employees on the worksite, and shall erect and properly maintain all necessary safeguards for protection of workers and the public. Awarded vendor shall post warning signs against all hazards created by the operation and work in progress. Proper precautions shall be taken pursuant to state law and standard practices to protect workers, general public and existing structures from injury or damage.

Smoking

Persons working under contract shall adhere to local smoking policies. Smoking will only be permitted in posted areas or off premises.

Invoices

The awarded vendor shall submit invoices to the participating entity clearly stating "Per TIPS Contract". The shipment tracking number or pertinent information for verification shall be made available upon request.

Marketing

Awarded vendor agrees to allow TIPS to use their name and logo within website, marketing materials and advertisement. Any use of TIPS name and logo or any form of publicity, inclusive of press release, regarding this contract by awarded vendor must have prior approval from TIPS.

Supplemental agreements

The entity participating in the TIPS contract and awarded vendor may enter into a separate supplemental agreement to further define the level of service requirements over and above the minimum defined in this contract i.e. invoice requirements, ordering requirements, specialized delivery, etc. Any supplemental agreement developed as a result of this contract is exclusively between the participating entity and awarded vendor. TIPS, its agents, TIPS members and employees shall not be made party to any claim for breach of such agreement.

Legal obligations

It is the responding vendor's responsibility to be aware of and comply with all local, state and federal laws governing the sale of products/services identified in this RFP and any awarded contract thereof. Applicable laws and regulations must be followed even if not specifically identified herein.

Audit rights

Awarded Vendor shall, at their sole expense, maintain appropriate due diligence of all purchases made by TIPS Member that utilizes this Contract. TIPS and Region 8 ESC each reserve the right to audit the accounting for a period of three (3) years from the time such purchases are made. This audit right shall survive termination of this Agreement for a period of one (1) year from the effective date of termination. TIPS shall have authority to conduct random audits of Awarded Vendor's pricing that is offered to TIPS Members. Notwithstanding the foregoing, in the event that TIPS is made aware of any pricing being offered to eligible entities that is materially inconsistent with the pricing under this agreement, TIPS shall have the ability to conduct the audit internally or may engage a third-party auditing firm. In the event of an audit, the requested materials shall be provided in the format and at the location designated by Region 8 ESC or TIPS.

Force Majeure

If by reason of Force Majeure, either party hereto shall be rendered unable wholly or in part to carry out its obligations under this Agreement then such party shall give notice and fully particulars of Force Majeure in writing to the other party within a reasonable time after occurrence of the event or cause relied upon, and the obligation of the party giving such notice, so far as it is affected by such Force Majeure, shall be suspended during the continuance of the inability then claimed, except as hereinafter provided, but for no longer period, and such party shall endeavor to remove or overcome such inability with all reasonable dispatch.

Services

When applicable, performance bonds will be required on construction or labor required jobs over \$100,000 and payment bonds on jobs over \$25,000 or awarded vendor will meet the TIPS member's local and state purchasing requirements. Awarded vendors may need to provide additional capacity as jobs increase. Bonds will not require that a fee be paid to TIPS. The actual cost of the bond will be a pass through to the TIPS member and added to the purchase order.

Scope of Services

The specific scope of work for each job shall be determined in advance and in writing between TIPS Member and Awarded vendor. It is okay if the TIPS member provides a general scope, but the awarded vendor should provide a written scope of work to the TIPS member as part of the proposal. Once the scope of the job is agreed to, the TIPS member will issue a PO with the estimate referenced as an attachment along with bond and any other special provisions agreed to for the TIPS member. If special terms and conditions other than those covered within this solicitation and awarded contracts are required, they will be attached to the PO and shall take precedence over those in the base contract.

Project Delivery Order Procedures

The TIPS member having approved and signed an interlocal agreement, or other TIPS membership document, may make a request of the awarded vendor under this contract when the TIPS member has services that need to be undertaken. Notification may occur via phone, the web, email, fax, or in person.

Upon notification of a pending request, the awarded vendor shall make contact with the TIPS member as soon as possible, but must make contact with the TIPS member within two working days.

Scheduling of Projects

Scheduling of projects (if applicable) will be accomplished when the TIPS member issues a purchase order that will serve as "the notice to proceed". The period for the delivery order will include the mobilization, materials purchase, installation and delivery, design, weather, and site cleanup and inspection. No additional claims may be made for delays as a result of these items. When the tasks have been completed the awarded vendor shall notify the client and have the TIPS member inspect the work for acceptance under the scope and terms in the PO. The TIPS member will issue in writing any corrective actions that are required. Upon completion of these items, the TIPS member will issue a completion notice and final payment will be issued.

Support Requirements

If there is a dispute between the awarded vendor and TIPS member, TIPS or its representatives will assist in conflict resolution or third party (mandatory mediation), if requested by either party. TIPS, or its representatives, reserves the right to inspect any project and audit the awarded vendors TIPS project files, documentation and correspondence.

Special Terms and Conditions

It is the intent of TIPS to contract with a reliable, high performance vendor to supply products and services to government and educational agencies. It is the experience of TIPS that the following procedures provide TIPS, the Vendor, and the participating agency the necessary support to facilitate a mutually beneficial relationship. The specific procedures will be negotiated with the successful vendor.

- **Contracts:** All vendor purchase orders must be emailed to TIPS at tipspo@tips-usa.com. Should an agency send an order direct to vendor, it is the vendor's responsibility to forward the order to TIPS at the email above within 24 business hours and confirm its receipt with TIPS.
 - **Promotion of Contract:** It is agreed that Vendor will encourage all eligible entities to purchase from the TIPS Program. Encouraging entities to purchase directly from the Vendor and not through TIPS contract is not acceptable to the terms and conditions of this contract and will result in removal of Vendor from Program. Vendor is expected to use marketing funds for the marketing and promotion of this contract.
 - **Daily Order Confirmation:** All contract purchase orders will be approved daily by TIPS and sent to vendor. The vendor must confirm receipt of orders to the TIPS member (customer) within 24 business hours.
 - **Vendor custom website for TIPS:** If Vendor is hosting a custom TIPS website, then updated pricing must be posted by 1st of each month.
 - **Back Ordered Products:** If product is not expected to ship within 3 business days, customer is to be notified within 24 hours and appropriate action taken based on customer request.
-

Check one of the following responses to the General Terms and Special Terms and Conditions:

() We take no exceptions/deviations to the general and/or special terms and conditions.

(Note: If none are listed below, it is understood that no exceptions/deviations are taken.)

() We take the following exceptions/deviations to the general and/or special terms and conditions. All exceptions/deviations must be clearly explained. Reference the corresponding general or special terms and conditions that you are taking exceptions/deviations to. The proposer must clearly state if you are adding additional terms and conditions to the general or special terms and conditions. Provide details on your exceptions/deviations below:

The Interlocal Purchasing System (TIPS Cooperative) Supplier Response

Bid Information		Contact Information		Ship to Information
Bid Creator	Kim Thompson Coordinator of Office Operations	Address	Region VIII Education Service Center 4845 US Highway 271 North Pittsburg, TX 75686	Address
Email	Kim.Thompson@tips-usa.com	Contact	Kim Thompson, TIPS Office Manager	Contact
Phone	(903) 575-2608			Department
Fax	(866) 929-4402			Building
Bid Number	7022516	Department		Floor/Room
Title	Sports Facility Lighting	Building		Telephone
Bid Type	RFP			Fax
Issue Date	12/02/2015	Floor/Room		Email
Close Date	1/15/2016 3:00:00 PM CT	Telephone	+1 (866) 839-8477	
Need by Date		Fax	+1 (866) 839-8472	
		Email	bids@tips-usa.com	

Supplier Information

Company RAISE Energy Solutions
 Address 1059 Triad Court, Suite 1
 Marietta, GA 30326

Contact
 Department
 Building
 Floor/Room
 Telephone 1 (678) 331-5548 104
 Fax 1
 Email

Submitted 1/15/2016 12:23:51 PM CT
 Total \$0.00

Signature Al Osbourne

Email al@raiseenergysolutions.com

Supplier Notes

Bid Notes

Bid Activities

Bid Messages

Please review the following and respond where necessary

#	Name	Note	Response
1	Yes - No	Disadvantaged/Minority/Women Business Enterprise - D/M/WBE (Required by some participating governmental entities) Vendor certifies that their firm is a D/M/WBE? Vendor must upload proof of certification to the "Response Attachments" D/M/WBE CERTIFICATES section.	Yes
2	Yes - No	Highly Underutilized Business - HUB (Required by some participating governmental entities) Vendor certifies that their firm is a HUB? Vendor must upload proof of certification to the "Response Attachments" HUB CERTIFICATES section.	Yes
3	Yes - No	The Vendor can provide services and/or products to all 50 US States?	Yes
4	States Served:	If answer is NO to question #3, please list which states can be served. (Example: AR, OK, TX)	
5	Company and/or Product Description:	This information will appear on the TIPS website in the company profile section, if awarded a TIPS contract. (Limit 750 characters.)	LED Lighting with Installation, Services and Maintenance
6	Primary Contact Name	Primary Contact Name	Al Osbourne
7	Primary Contact Title	Primary Contact Title	Director US Sales
8	Primary Contact Email	Primary Contact Email	al@raiseenergysolutions.com
9	Primary Contact Phone	Enter 10 digit phone number. (No dashes or extensions)	4046451557
10	Primary Contact Fax	Enter 10 digit phone number. (No dashes or extensions)	6783315548
11	Primary Contact Mobile	Enter 10 digit phone number. (No dashes or extensions)	
12	Secondary Contact Name	Secondary Contact Name	Gabby Turner
13	Secondary Contact Title	Secondary Contact Title	Customer Support Specialist
14	Secondary Contact Email	Secondary Contact Email	gabby@raiseenergysolutions.com
15	Secondary Contact Phone	Enter 10 digit phone number. (No dashes or extensions)	6783315548
16	Secondary Contact Fax	Enter 10 digit phone number. (No dashes or extensions)	6783315548
17	Secondary Contact Mobile	Enter 10 digit phone number. (No dashes or extensions)	
18	Admin Fee Contact Name	Admin Fee Contact Name. This person is responsible for paying the admin fee to TIPS.	Gabby Turner
19	Admin Fee Contact Email	Admin Fee Contact Email	gabby@raiseenergysolutions.com
20	Admin Fee Contact Phone	Enter 10 digit phone number. (No dashes or extensions)	6783315548
21	Purchase Order Contact Name	Purchase Order Contact Name. This person is responsible for receiving Purchase Orders from TIPS.	Gabby Turner
22	Purchase Order Contact Email	Purchase Order Contact Email	gabby@raiseenergysolutions.com
23	Purchase Order Contact Phone	Enter 10 digit phone number. (No dashes or extensions)	6783315548
24	Company Website	Company Website (Format - www.company.com)	www.raiseenergysolutions.com
25	Federal ID Number:	Federal ID Number also known as the Employer Identification Number. (Format - 12-3456789)	46-2212848

26	Primary Address	Primary Address	1059 Triad Court Suite 1
27	Primary Address City	Primary Address City	Marietta
28	Primary Address State	Primary Address State (2 Digit Abbreviation)	Georgia
29	Primary Address Zip	Primary Address Zip	30062
30	Search Words:	Please list search words to be posted in the TIPS database about your company that TIPS website users might search. Words may be product names, manufacturers, or other words associated with the category of award. YOU MAY NOT LIST NON-CATEGORY ITEMS. (Limit 500 words) (Format: product, paper, construction, manufacturer name, etc.)	LED Lighting HVAC Efficiency Solar Energy
31	Yes - No	Do you wish to be eligible to participate in a TIPS contract in which a TIPS member utilizes federal funds on contracts exceeding \$100,000? (Non-Construction) (If YES, vendor should download the Federal Regulations for Contracts document from the Attachments section, fill out the form and submit the document in the "Response Attachments" FEDERAL FUNDS section.) (Vendor must also download the Suspension or Debarment Certificate document from the Attachments section, fill out the form and submit the document in the "Response Attachments" SUSPENSION OR DEBARMENT section.)	No
32	Yes - No	Certification of Residency (Required by the State of Texas) Company submitting bid is a Texas resident bidder?	No
33	Company Residence (City)	Vendor's principal place of business is in the city of?	Marietta
34	Company Residence (State)	Vendor's principal place of business is in the state of?	Georgia
35	Felony Conviction Notice:	(Required by the State of Texas) My firm is, as outlined on PAGE 5 in the Instructions to Bidders document: (Questions 36 - 37)	(No Response Required)
36	Yes - No	A publicly held corporation; therefore, this reporting requirement is not applicable?	No
37	Yes - No	Is owned or operated by individual(s) who has/have been convicted of a felony? If answer is YES, a detailed explanation of the name(s) and conviction(s) must be uploaded to the "Response Attachments" FELONY CONVICTION section.	No
38	Pricing Information:	Pricing information section. (Questions 39 - 42)	(No Response Required)
39	Yes - No	In addition to the typical unit pricing furnished herein, the Vendor agrees to furnish all current and future products at prices that are proportionate to Dealer Pricing. If answer is NO, include a statement detailing how pricing for TIPS participants would be calculated in the PRICING document that is uploaded to the "Response Attachments" PRICING section.	Yes
40	Yes - No	Pricing submitted includes the TIPS administration fee?	Yes
41	Yes - No	Vendor agrees to remit to TIPS the required administration fee?	Yes
42	Yes - No	Additional discounts to TIPS members for bulk quantities or scope of work?	Yes

- 43 Start Time Average start time after receipt of customer order is ____ 15
working days?
- 44 Years Experience Company years experience in this category? 3.5
- 45 Resellers: Does the vendor have resellers that it will name under this contract? (If applicable, vendor should download the Reseller/Dealers spreadsheet from the Attachments section, fill out the form and submit the document in the "Response Attachments" RESELLERS section. Yes
- 46 Prices are guaranteed for? (___Month(s), ___ Year(s), or Term of Contract) (Standard Term of Contract term is "Term of Contract")

Line Items

Response Total: \$0.00

CONTRACT Signature Form

The undersigned hereby proposes and agrees to furnish goods and/or services in compliance with the terms, specifications and conditions at the prices quoted unless noted in writing. The undersigned further certifies that he or she is an authorized agent of the company and has authority to negotiate and contract for the company named below.

Company Name: KAISE ENERGY SOLUTIONS

Mailing Address: 1059 TRIAD COURT SUITE 1

City: MARIETTA

State: GEORGIA

Zip: 30062

Telephone Number: 678-331-5548

Fax Number: 678-331-5548

Email Address: AL@RAISEENERGYSOLUTIONS.COM

Authorized Signature: 

Printed Name: A.S. OSBOURNE

Position: DIRECTOR US SALES

This contract is for a total TERM of one year with the option of two additional years. Vendors shall honor the participation fee for any sales made based on the TIPS contract. Failure to pay the fee will be grounds for termination of contract and will affect the award of future contracts.

Blenda McNat 2/25/16
TIPS Authorized Signature Date

David Wayne Fitts 2/25/16
Approved by Region VIII ESC Date

References

**** Must have at least 3 References. References must be School, City, County, University, State Agency or Other Government.**

Organization	City	State	Contact Name	Contact Phone
Carrier Enterprises			Sam Mullins	901-433-1926 Office
Atlanta AirLines Terminal Corporation	Atlanta	Georgia	Purcell Matthews	404-530-2508 Office
Enveniam Corporation	Atlanta	Georgia	Neal Starling	770-552-8602 x124 Office

Model No:
SL-160W-5000K

New iL Series Street & Parking Light

Replaces: 320-400W HID



SPECIFICATIONS



Web: www.raiseenergysolutions.com
E-mail: info@raiseenergysolutions.com
Tel: 678.331.5548
Address: 1059 Triad Ct. Suite 1
Marietta, GA 30062

Superb Design

Through years of experience in street and parking lot lighting, the new 2015 iL Series street & parking light was born. This new series is the result of a multi-disciplinary design study and it applies the latest technologies developed by R&D. The product's reliability and performance are factors to consider and they are verified and tested by professionally qualified personnel.

The iL series street light is equipped with the latest universal LED modules, delivering superb performance of LED Lighting and high reliability.

Reliable LED Lighting Technology

Reliable LED Lighting Technology provides significant advantages in terms of luminous efficiency, minimizing losses refraction and reflection inside the optical system. This system ensures a lower density of dirt maintaining the luminaire's performance for a very long period of time.

Protection for the LED Source

As the key to guarantee the total life span of the luminaire, the protection of the LED source was at the forefront in the design of the luminaire. The carefully selected Mitsubishi PC cover and waterproof rubber ring ensures the total IP of the whole product. It also protects the LED chip from external agents and damage.

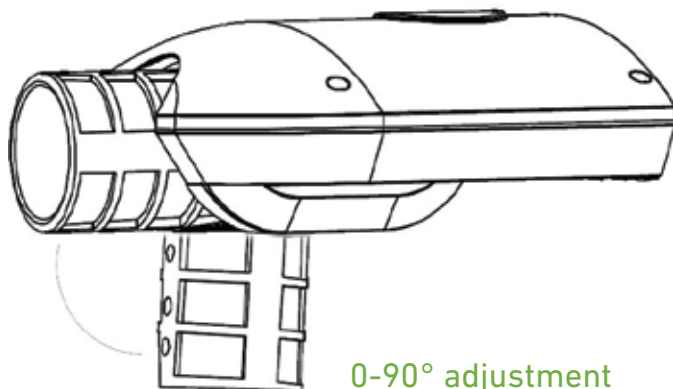
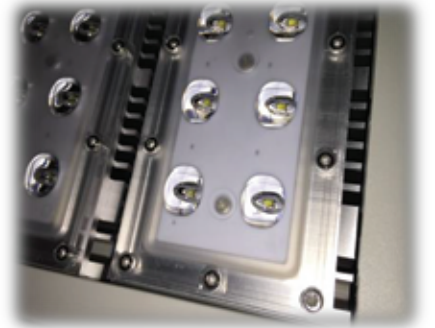

0-90° Bracket Adjustment

The angles of the bracket of iL street light can be adjusted from 0 to 90 degrees to fit different styles of poles.

Temperature Control

The iL street light is designed with superb heat radiation technique. The heat and air can go through the whole luminaire via the gaps between the modules. This product also has a self-cleaning ability. When raining, the fixture will be washed and the dirt automatically rinses out.

The iL street light has excellent heat radiation ability. The temperature rise is less than $<26^{\circ}\text{C}$. And the lamp can work in environments from -40°C to 50°C . If the environment is 40°C , the maximized temperature of the lamp is 66°C . But the Philips Luxeon T chips can afford 110°C . This ensures a long life span and performance of the whole luminaire.



Diversified Installation Methods

The iL street light suitable for all installation methods. Its standard bracket angle can be adjusted from 0-90 degrees. And it can also be installed on the square shaped pole by simply adding an extra converter.

The standard bracket of the iL street light is based on a 60mm round port. There are many different bracket converters that can be used with the iL street light, such as round to square, 60-48mm, 60-80mm, etc.

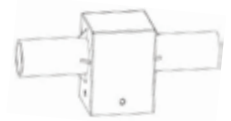
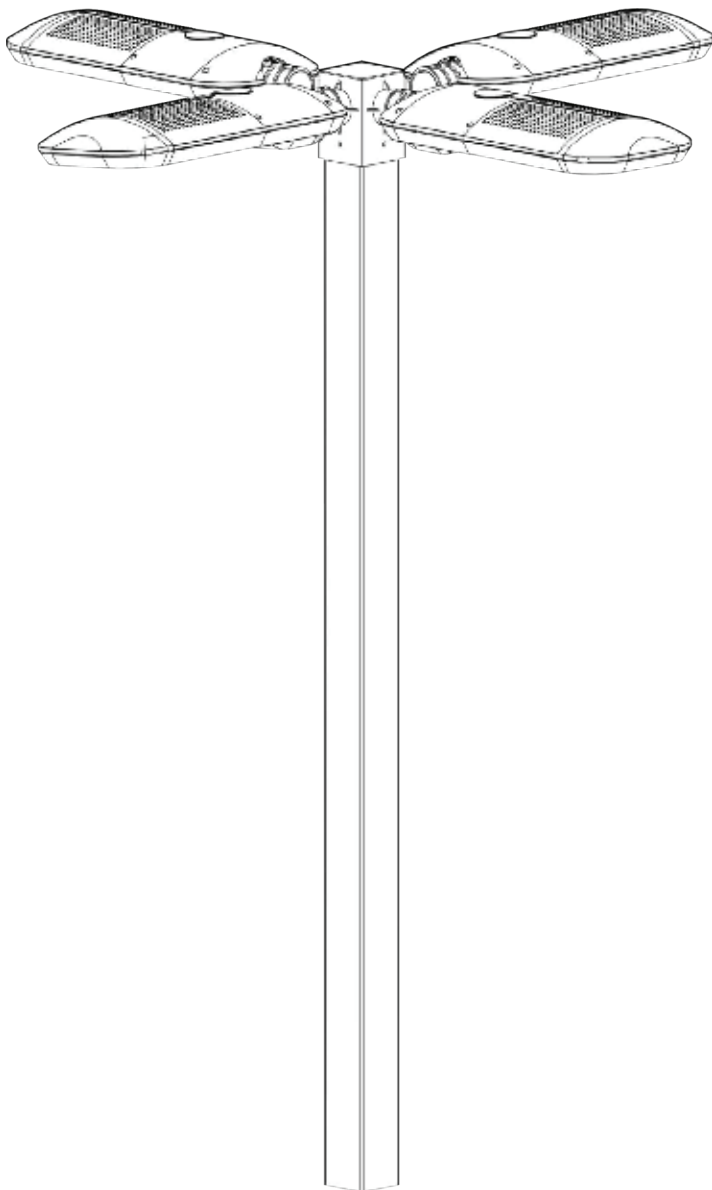

2 in 1 converter

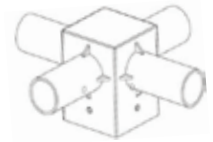

4 in 1 converter

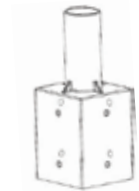

Round to square converter

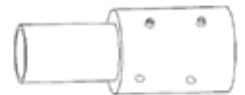

80-60mm converter



wall mount converter



60-40mm converter

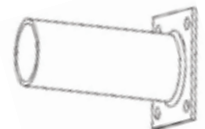

60mm to wall mount converter

Multiple Light Distribution Options

Street light & parking light should be able to be used in a wide range of applications. Such as highways, express ways, roads, avenues, walking paths or parking lots. Thus, we provide different lens options for the iL Series street light to achieve different light distributions.

The iL Street Light follows the North American IESNA standard in providing the optional lens with Type II and Type III. The Type II lens is suitable for highways with 2 lanes, Type III A is for 3 lanes and Type III B is for even wider roads. We select the most suitable lens for our customers according to detailed project parameters.

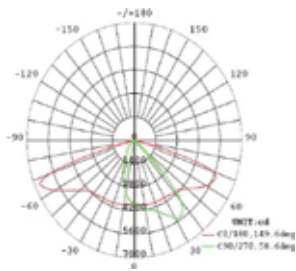

Type II: 60*150

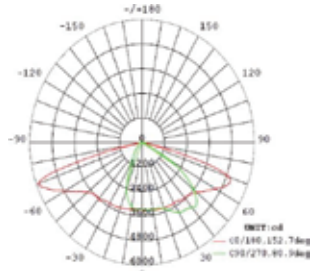
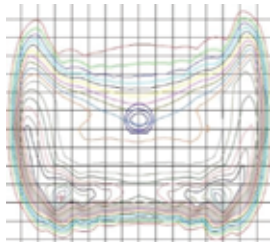

Type III A: 70*150

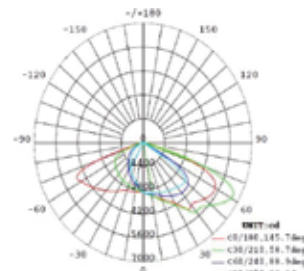
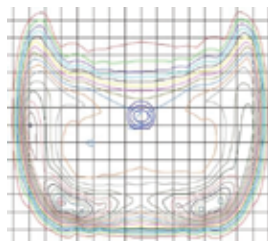

Type III B: 80*150 degrees

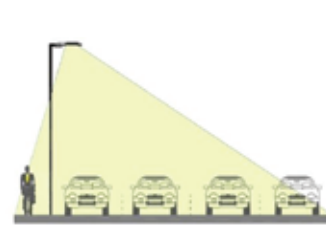
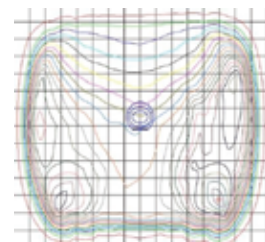

90*100 degree lens for Parking Lot

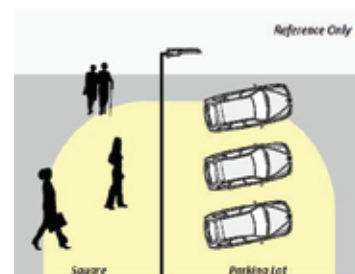
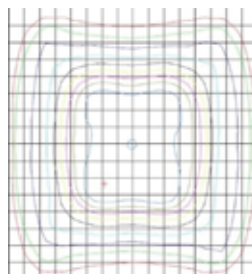
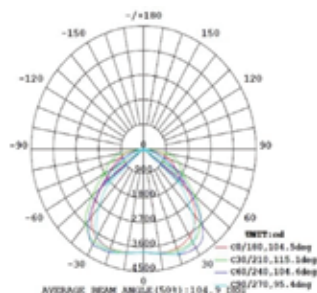

Type II Lens

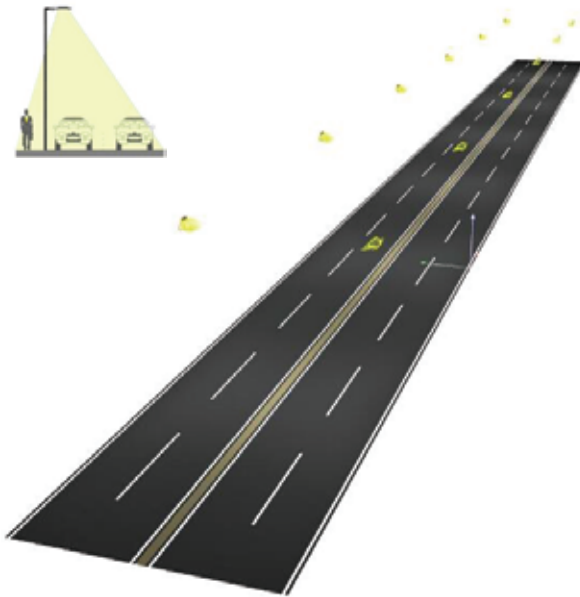

The Type II lens of the iL series street light has a beam angle of 60*150 degrees. In the IESNA standard, the Type II lens is normally used in the entrance of wide sidewalks, bicycle paths, streets or any other long but narrow areas. For this lens, the street light needs to be installed on the side of the road instead of middle. The width of the light distribution is about 1.75 times than the installation height of the street light.

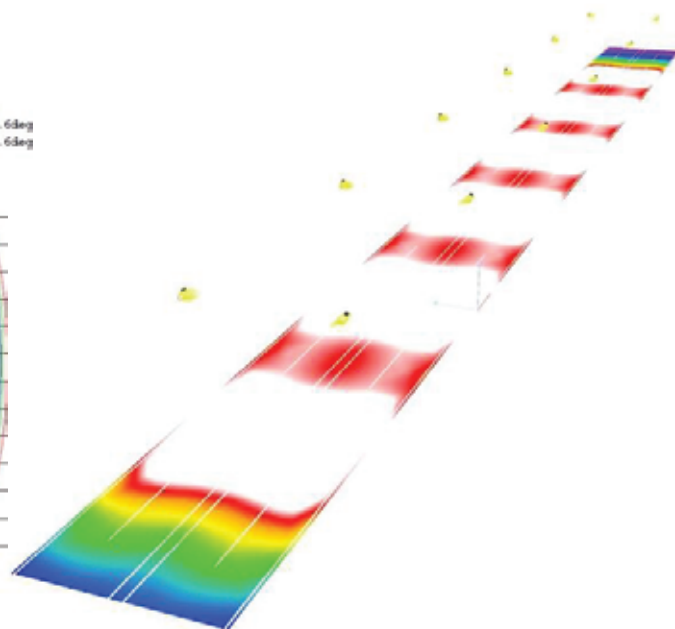
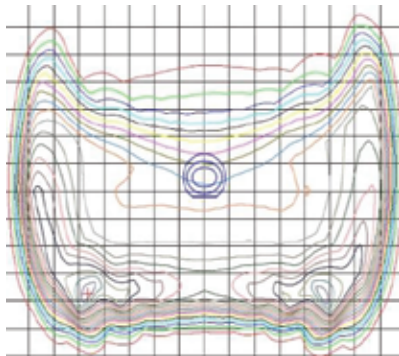
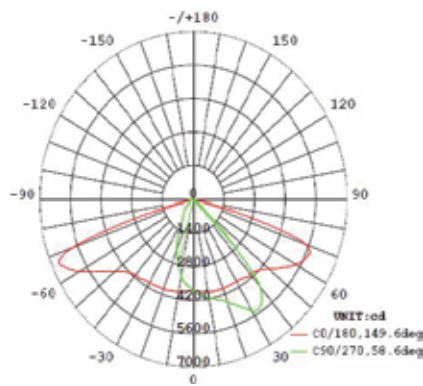

Type III-A Lens

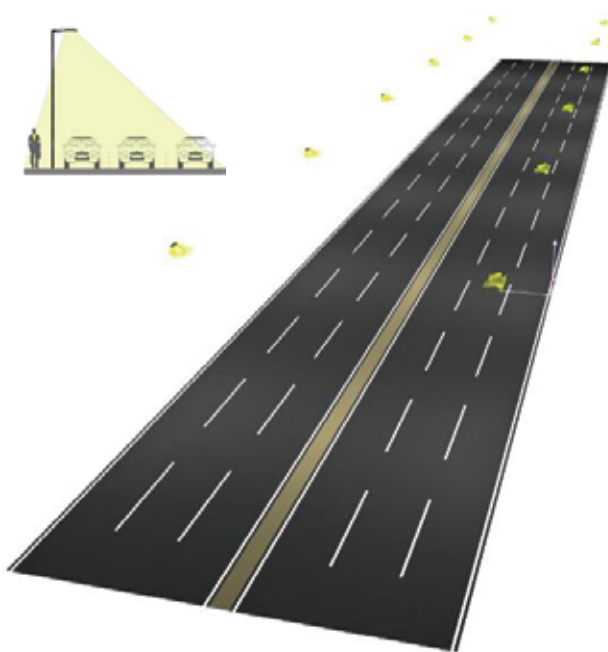

The Type III A lens of the iL series street light has a beam angle of 70*150 degrees. In the IESNA standard, the Type III lens is normally used for highways or expressways. The street light is also installed on the side of the road. And the light distribution is 2.75 times the installation height of the street light.

There are 2 kinds of Type III lenses: Type III A and Type III B. The Type III A is used mainly for streets with 3 lanes.

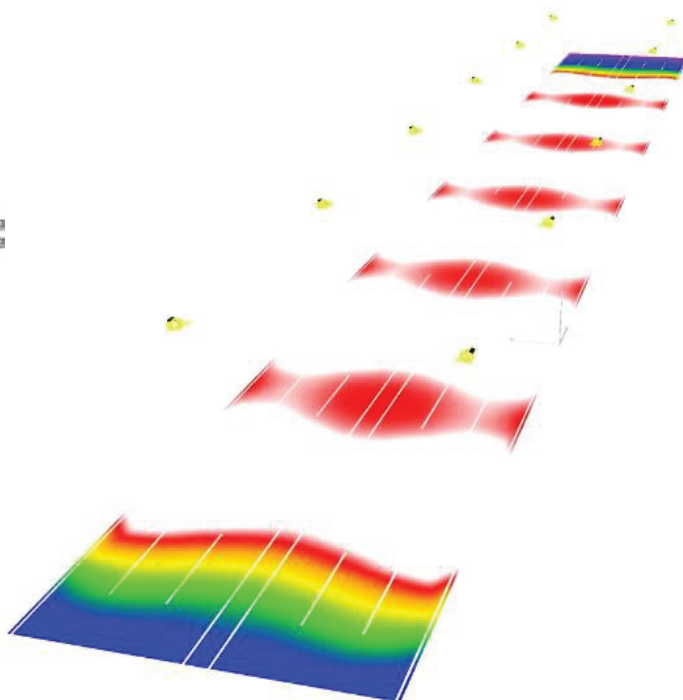
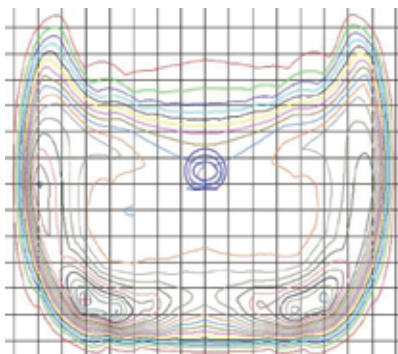
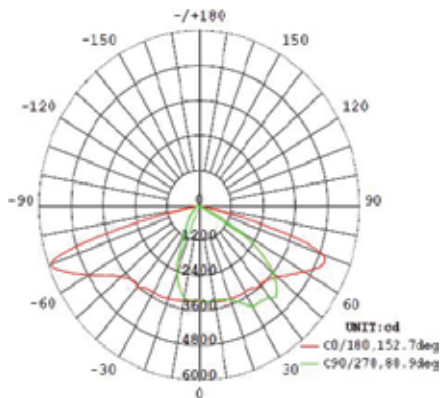

Type III-B Lens

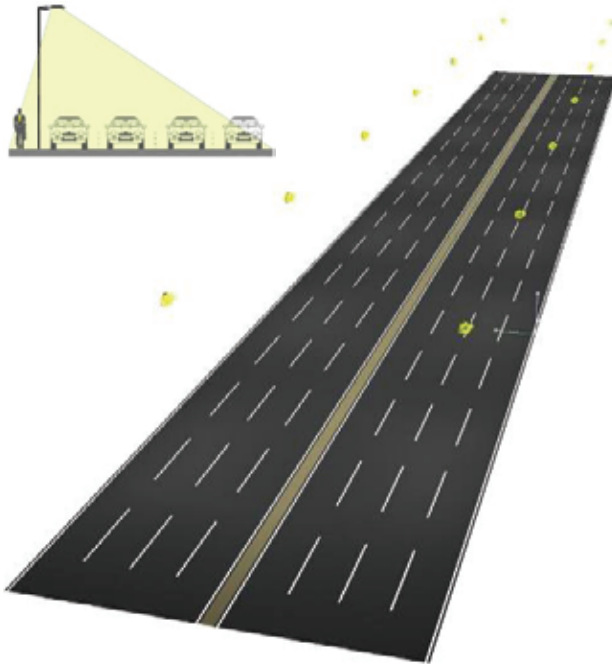

The Type III B lens of the iL series street light has a beam angle of 80*150 degrees. In the IESNA standard, the Type III lens is normally used for highways or expressways. The street light is also installed on the side of the road. And the light distribution is 2.75 times than the installtion height of the street light.

The Type III B lens has even longer distributions on vertical directions. The 80*150 beam angle makes it suitable for streets with 4 lanes.

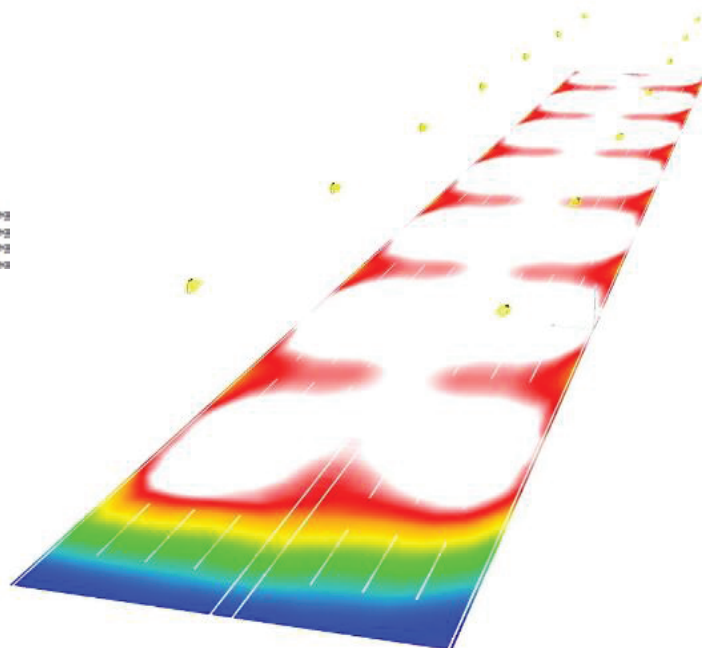
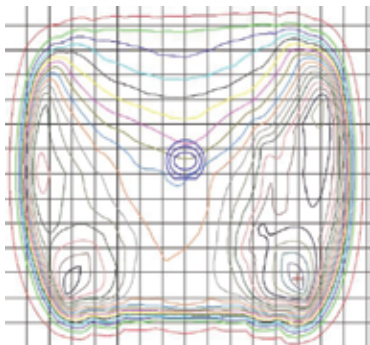
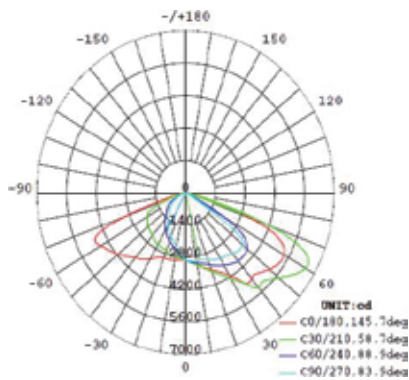

Solar Street Light System

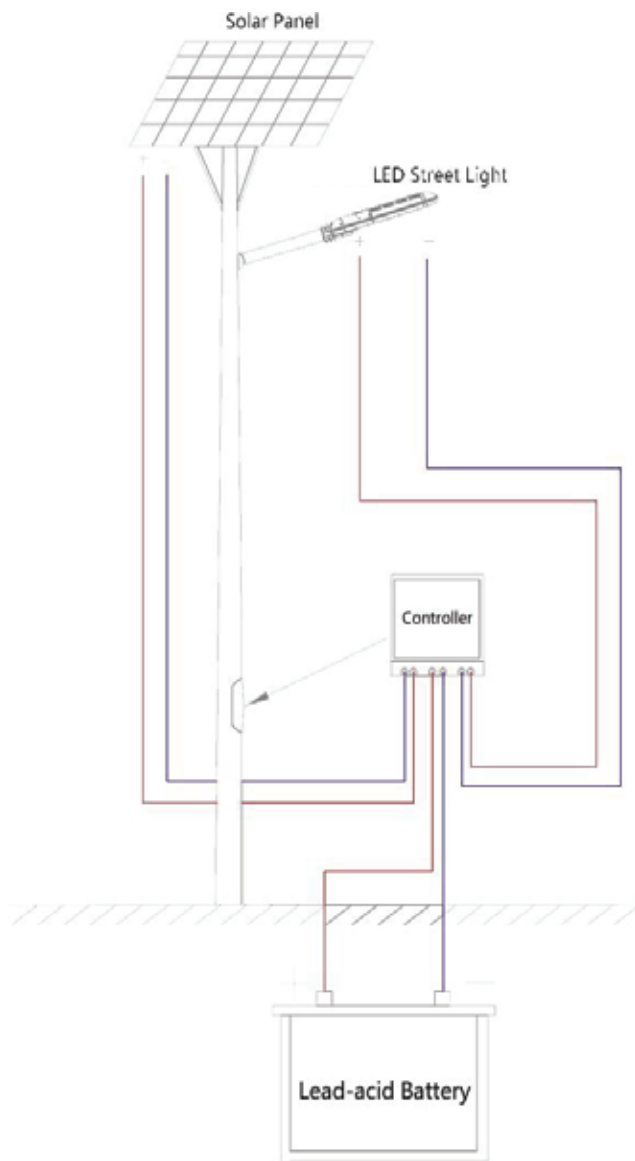

40 Watt DC version
SL-40W-5000K-iL-12



80 Watt DC version
SL-80W-5000K-iL-24



120 Watt DC version
SL-120W-5000K-iL-24

We provide a comprehensive solution for LED solar street lighting system. The 40W, 80W and 120W models of the iL series street lights are suitable for this application.

The standard solar lighting system includes a DC version street light (40W, 80W or 120W), a solar panel, controller and the lead-acid battery. The 40W is based on 12VDC and 24VDC, the 80W and 120W models are based on 24VDC.

Intelligent Street Lighting System

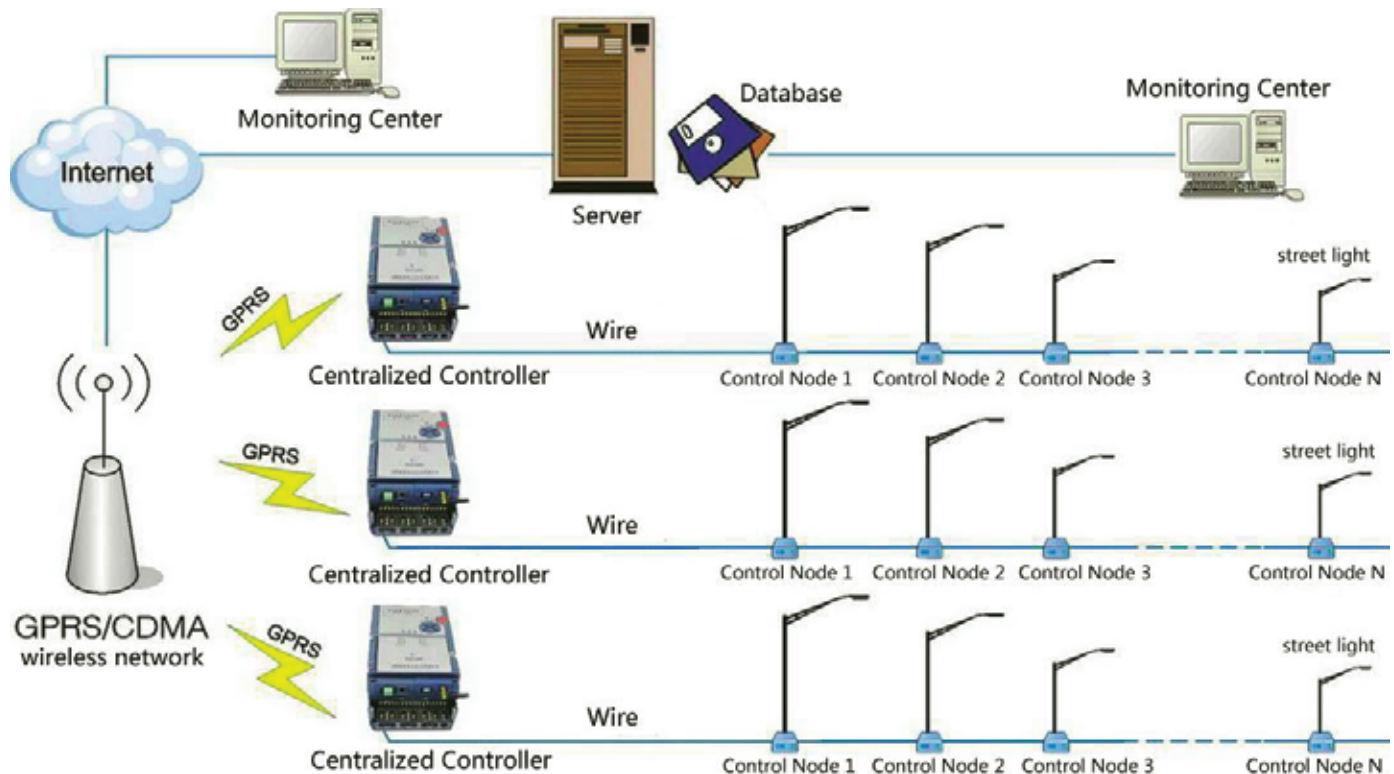

We provide a total solution for intelligent street lighting systems, like the DALI system or Zigbee system. The whole system is driven by GPRS or CDMA wireless networks. For example, the intelligent street lighting system of 3 roads will consist of a centralized controller on each road and a single light controller on each pole. Each single street light is a control node in the system. And the whole system is monitored and controlled by a general monitoring center with specialized software.



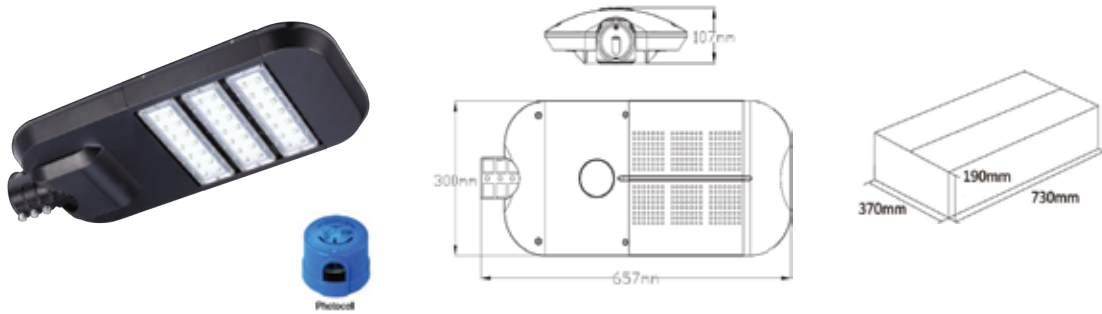

Specifications:	320-400W HID Replacement
Nominal Wattage	160W
Nominal Voltage	90-305VAC, 50/60Hz
Maximum Current	AC 1.80A (max)
Power Factor (PF)	>0.95
Driver Efficiency	>92%
Luminous Flux	+Lumen tolerance +/- 5% 16,000-17,600lm
CRI	Ra>78
CCT	5000K, Optional: 3000K, 4000K, 6500K
Optional Beam Angle	Type II: 90*100°, Type III-A: 30°, 60°, Type III-B: 120°
IP&IK Rating	IP67 & IK10
Lifetime	62000 hours - L70, @25°C
Dimming	1-10V or PWM
Heat Radiator	Anodized Aluminum
Lens	PC
Housing Colors	Black, White, Silver, or Bronze 
Fixture Dimensions	738*300*107mm (29.1*11.8*4.2 inches)
Net Weight	9.7kg
Carton Dimensions	810*370*190mm
Gross Weight	10.6kg
Warranty	8 Years

Optional converters for different applications:

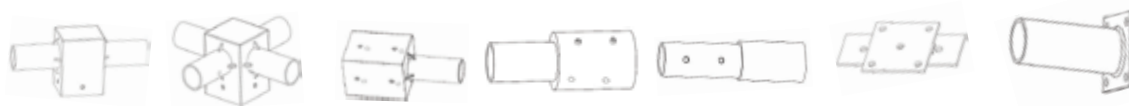

Raise Energy Solutions

Warranty

LED Product Warranty is 50,000 Hours

Federal Requirements for Procurement and Contracting with small and minority businesses, women's business enterprises, and labor surplus area firms.

If the TIPS member anticipate possibly using federal funds for procurement under this potential award and is required to obtain the following compliance assurance.

1. Will you be subcontracting any of your work under this award if you are successful?

(Check one)

YES or NO

2. If yes, do you agree to comply with the following federal requirements? (Check one)

YES or NO

2 CFR §200.321 Contracting with small and minority businesses, women's business enterprises, and labor surplus area firms.

(a) The non-Federal entity must take all necessary affirmative steps to assure that minority businesses, women's business enterprises, and labor surplus area firms are used when possible.

(b) Affirmative steps must include:

- (1) Placing qualified small and minority businesses and women's business enterprises on solicitation lists;
- (2) Assuring that small and minority businesses, and women's business enterprises are solicited whenever they are potential sources;
- (3) Dividing total requirements, when economically feasible, into smaller tasks or quantities to permit maximum participation by small and minority businesses, and women's business enterprises;
- (4) Establishing delivery schedules, where the requirement permits, which encourage participation by small and minority businesses, and women's business enterprises;
- (5) Using the services and assistance, as appropriate, of such organizations as the Small Business Administration and the Minority Business Development Agency of the Department of Commerce ; and
- (6) Requiring the prime contractor, if subcontracts are to be let, to take the affirmative steps listed in paragraphs (1) through (5) of this section.

Company Name RAISE ENERGY SOLUTIONS

Name of authorized representative AL OSBOURNE

Signature of authorized representative 

Date 1/15/2016

Federal Requirements for Procurement and Contracting with small and minority businesses, women's business enterprises, and labor surplus area firms.

If the TIPS member anticipate possibly using federal funds for procurement under this potential award and is required to obtain the following compliance assurance.

1. Will you be subcontracting any of your work under this award if you are successful?

(Check one)

YES or NO

2. If yes, do you agree to comply with the following federal requirements? (Check one)

YES or NO

2 CFR §200.321 Contracting with small and minority businesses, women's business enterprises, and labor surplus area firms.

(a) The non-Federal entity must take all necessary affirmative steps to assure that minority businesses, women's business enterprises, and labor surplus area firms are used when possible.

(b) Affirmative steps must include:

- (1) Placing qualified small and minority businesses and women's business enterprises on solicitation lists;
- (2) Assuring that small and minority businesses, and women's business enterprises are solicited whenever they are potential sources;
- (3) Dividing total requirements, when economically feasible, into smaller tasks or quantities to permit maximum participation by small and minority businesses, and women's business enterprises;
- (4) Establishing delivery schedules, where the requirement permits, which encourage participation by small and minority businesses, and women's business enterprises;
- (5) Using the services and assistance, as appropriate, of such organizations as the Small Business Administration and the Minority Business Development Agency of the Department of Commerce ; and
- (6) Requiring the prime contractor, if subcontracts are to be let, to take the affirmative steps listed in paragraphs (1) through (5) of this section.

Company Name RAISE ENERGY SOLUTIONS

Name of authorized representative AL OSBOURNE

Signature of authorized representative 

Date 1/15/2016

2 CFR PART 200 Contract Provisions

Required Federal contract provisions of Federal Regulations for Contracts

The following provisions are required to be in place and agreed if the procurement is funded with federal funds. TIPS or its members are the subgrantee or subrecipient by definition in most cases. Not all provisions herein apply to all contracts. Compliance is required as it applies to the individual purchase contract.

Appendix II to Part 200

Contract Provisions for Non-Federal Entity Contracts Under Federal Awards

2 CFR PART 200

These contract provisions are incorporated by reference or attachment into all contracts with your company when TIPS or its members purchase is with federal funds if you respond to a TIPS competitive procurement request for proposals or bid..

In addition to other provisions required by the Federal agency or non-Federal entity, all contracts made by the non-Federal entity under the Federal award must contain provisions covering the following, as applicable.

Federal Rule (1) Contracts for more than the simplified acquisition threshold currently set at \$150,000, which is the inflation adjusted amount determined by the Civilian Agency Acquisition Council and the Defense Acquisition Regulations Council (Councils) as authorized by 41 U.S.C. 1908, must address administrative, contractual, or legal remedies in instances where contractors violate or breach contract terms, and provide for such sanctions and penalties as appropriate.

Notice: Pursuant to Federal Rule (1) above, when federal funds are expended by TIPS or its members, TIPS or its members reserves all rights and privileges under the applicable laws and regulations with respect to this procurement in the event of breach of contract by either party.

Does vendor agree? YES Initial of Authorized Company Official COM

Federal Rule (2) Termination for cause and for convenience by the grantee or subgrantee including the manner by which it will be effected and the basis for settlement. (All contracts in excess of \$10,000)

Pursuant to Federal Rule (2) above, when federal funds are expended by TIPS OR ITS MEMBERS, TIPS OR ITS MEMBERS reserves the right to terminate any agreement in excess of \$10,000 resulting from this procurement process for cause after giving the vendor an appropriate opportunity and up to 30 days, to cure the causal breach of terms and conditions. TIPS OR ITS MEMBERS reserves the right to terminate any agreement in excess of \$10,000 resulting from this procurement process for convenience with 30 days notice in writing to the awarded vendor. The vendor would be compensated for work performed and goods procured as of the termination date if for convenience of the TIPS OR ITS MEMBERS. Any award under this procurement process is not exclusive and the District reserves the right to purchase goods and services from other vendors when it is in the best interest of the District.

Does vendor agree? YES Initial of Authorized Company Official COM

Federal Rule (3) Equal Employment Opportunity. Except as otherwise provided under 41 CFR Part 60, all contracts that meet the definition of "federally assisted construction contract" in 41 CFR Part 60-1.3 must include the equal opportunity clause provided under 41 CFR 60-1.4(b), in accordance with Executive Order 11246, "Equal Employment Opportunity" (30 FR 12319, 12935, 3 CFR Part, 1964-1965 Comp., p. 339), as amended by Executive Order 11375, "Amending Executive Order 11246 Relating to Equal Employment Opportunity," and implementing regulations at 41 CFR part 60, "Office of Federal Contract Compliance Programs, Equal Employment Opportunity, Department of Labor."

2 CFR PART 200 Contract Provisions

Pursuant to Federal Rule (3) above, when federal funds are expended by TIPS OR ITS MEMBERS, for all construction contracts awarded by grantees and their contractors or subgrantees, the proposer certifies that during the term of an award, when federal funds are expended, by the TIPS OR ITS MEMBERS resulting for this procurement process the vendor will be in compliance with Equal Opportunity Employment laws specifically Executive Order 11246 of September 24, 1965, entitled "Equal Employment Opportunity," as amended by Executive Order 11375 of October 13, 1967, and as supplemented in Department of Labor regulations (41 CFR chapter 60).

Does vendor agree? YES Initial of Authorized Company Official COM

Federal Rule (4) Davis-Bacon Act, as amended (40 U.S.C. 3141-3148). When required by Federal program legislation, all prime construction contracts in excess of \$2,000 awarded by non-Federal entities must include a provision for compliance with the Davis-Bacon Act (40 U.S.C. 3141-3144, and 3146-3148) as supplemented by Department of Labor regulations (29 CFR Part 5, "Labor Standards Provisions Applicable to Contracts Covering Federally Financed and Assisted Construction"). In accordance with the statute, contractors must be required to pay wages to laborers and mechanics at a rate not less than the prevailing wages specified in a wage determination made by the Secretary of Labor. In addition, contractors must be required to pay wages not less than once a week. The non-Federal entity must place a copy of the current prevailing wage determination issued by the Department of Labor in each solicitation. The decision to award a contract or subcontract must be conditioned upon the acceptance of the wage determination. The non-Federal entity must report all suspected or reported violations to the Federal awarding agency. The contracts must also include a provision for compliance with the Copeland "Anti-Kickback" Act (40 U.S.C. 3145), as supplemented by Department of Labor regulations (29 CFR Part 3, "Contractors and Subcontractors on Public Building or Public Work Financed in Whole or in Part by Loans or Grants from the United States"). The Act provides that each contractor or subrecipient must be prohibited from inducing, by any means, any person employed in the construction, completion, or repair of public work, to give up any part of the compensation to which he or she is otherwise entitled. The non-Federal entity must report all suspected or reported violations to the Federal awarding agency.

Pursuant to Federal Rule (4) above, when federal funds are expended by TIPS OR ITS MEMBERS, during the term of an award for all contracts and subgrants for construction or repair, when Federal Funds are expended, by the TIPS OR ITS MEMBERS resulting for this procurement process the vendor will be in compliance with all provisions listed or referenced therein.

Does vendor agree? YES Initial of Authorized Company Official COM

Federal Rule (5) Contract Work Hours and Safety Standards Act (40 U.S.C. 3701-3708). Where applicable, all contracts awarded by the non-Federal entity in excess of \$100,000 that involve the employment of mechanics or laborers must include a provision for compliance with 40 U.S.C. 3702 and 3704, as supplemented by Department of Labor regulations (29 CFR Part 5). Under 40 U.S.C. 3702 of the Act, each contractor must be required to compute the wages of every mechanic and laborer on the basis of a standard work week of 40 hours. Work in excess of the standard work week is permissible provided that the worker is compensated at a rate of not less than one and a half times the basic rate of pay for all hours worked in excess of 40 hours in the work week. The requirements of 40 U.S.C. 3704 are applicable to construction work and provide that no laborer or mechanic must be required to work in surroundings or under working conditions which are unsanitary, hazardous or dangerous. These requirements do not apply to the purchases of supplies or materials or articles ordinarily available on the open market, or contracts for transportation or transmission of intelligence.

Pursuant to Federal Rule (5) above, when federal funds are expended by TIPS OR ITS MEMBERS, the proposer certifies that during the term of an award by the TIPS OR ITS MEMBERS resulting from this procurement process for construction contracts awarded by grantees and subgrantees the proposer agrees to be in compliance with all requirements listed or referenced therein.

Does vendor agree? YES Initial of Authorized Company Official COM

Federal Rule (6) Rights to Inventions Made Under a Contract or Agreement. If the Federal award meets the definition of "funding agreement" under 37 CFR §401.2 (a) and the recipient or subrecipient wishes to enter into a contract with a

2 CFR PART 200 Contract Provisions

small business firm or nonprofit organization regarding the substitution of parties, assignment or performance of experimental, developmental, or research work under that “funding agreement,” the recipient or subrecipient must comply with the requirements of 37 CFR Part 401, “Rights to Inventions Made by Nonprofit Organizations and Small Business Firms Under Government Grants, Contracts and Cooperative Agreements,” and any implementing regulations issued by the awarding agency.

Pursuant to Federal Rule (6) above, when federal funds are expended by TIPS OR ITS MEMBERS, TIPS OR ITS MEMBERS requires that the proposer certify that during the term of an award by the TIPS OR ITS MEMBERS resulting from this procurement process the vendor agrees to the terms listed and referenced therein.

Does vendor agree? YES COM Initial of Authorized Company Official

Federal Rule (7) Clean Air Act (42 U.S.C. 7401-7671q.) and the Federal Water Pollution Control Act (33 U.S.C. 1251-1387), as amended—Contracts and subgrants of amounts in excess of \$150,000 must contain a provision that requires the non-Federal award to agree to comply with all applicable standards, orders or regulations issued pursuant to the Clean Air Act (42 U.S.C. 7401-7671q) and the Federal Water Pollution Control Act as amended (33 U.S.C. 1251-1387). Violations must be reported to the Federal awarding agency and the Regional Office of the Environmental Protection Agency (EPA).

Pursuant to Federal Rule (7) above, when federal funds are expended by TIPS OR ITS MEMBERS, TIPS OR ITS MEMBERS requires that the proposer certify that during the term of an award by the TIPS OR ITS MEMBERS resulting from this procurement process the vendor agrees to the terms listed and referenced therein.

Does vendor agree? YES COM Initial of Authorized Company Official

Federal Rule (8) Debarment and Suspension (Executive Orders 12549 and 12689)—A contract award \$25,000 or greater (see 2 CFR 180.220) must not be made to parties listed on the governmentwide exclusions in the System for Award Management (SAM), in accordance with the OMB guidelines at 2 CFR 180 that implement Executive Orders 12549 (3 CFR part 1986 Comp., p. 189) and 12689 (3 CFR part 1989 Comp., p. 235), “Debarment and Suspension.” SAM Exclusions contains the names of parties debarred, suspended, or otherwise excluded by agencies, as well as parties declared ineligible under statutory or regulatory authority other than Executive Order 12549.

Pursuant to Federal Rule (8) above, when federal funds are expended by TIPS OR ITS MEMBERS, TIPS OR ITS MEMBERS requires the proposer certify that during the term of an award by the TIPS OR ITS MEMBERS resulting for this procurement process the vendor certifies that they are not debarred from receiving a contract from the federal government as provided therein.

Does vendor agree they are not debarred as specified above ? YES COM Initial of Authorized Company Official

Federal Rule (9) Byrd Anti-Lobbying Amendment (31 U.S.C. 1352)—Contractors that apply or bid for an award exceeding \$100,000 must file the required certification. Each tier certifies to the tier above that it will not and has not used Federal appropriated funds to pay any person or organization for influencing or attempting to influence an officer or employee of any agency, a member of Congress, officer or employee of Congress, or an employee of a member of Congress in connection with obtaining any Federal contract, grant or any other award covered by 31 U.S.C. 1352. Each tier must also disclose any lobbying with non-Federal funds that takes place in connection with obtaining any Federal award. Such disclosures are forwarded from tier to tier up to the non-Federal award.

Pursuant to Federal Rule (9) above, when federal funds are expended by TIPS OR ITS MEMBERS, TIPS OR ITS MEMBERS requires the proposer certify that during the term and after the awarded term of an award by the TIPS OR ITS MEMBERS resulting for this procurement process the vendor certifies to the terms included or referenced in Federal Rule 9 above.

2 CFR PART 200 Contract Provisions

Does vendor certify to the provisions in Federal Rule (9) above? YES CDM Initial of Authorized Company Official

Federal Rule (10) 2 CFR 200.233 Retention of all required records for three years after grantees or subgrantees make final payments and all other pending matters are closed.

Pursuant to Federal Rule (10) above, when federal funds are expended by TIPS OR ITS MEMBERS, TIPS OR ITS MEMBERS requires the proposer certify that the awarded vendor retain all required records for three years after grantees or subgrantees make final payments and all other pending matters are closed.

Does vendor agree? YES CDM Initial of Authorized Company Official

Federal Rule (11) 2 CFR §200.322 Procurement of recovered materials. A non-Federal entity that is a state agency or agency of a political subdivision of a state and its contractors must comply with section 6002 of the Solid Waste Disposal Act, as amended by the Resource Conservation and Recovery Act. The requirements of Section 6002 include procuring only items designated in guidelines of the Environmental Protection Agency (EPA) at 40 CFR part 247 that contain the highest percentage of recovered materials practicable, consistent with maintaining a satisfactory level of competition, where the purchase price of the item exceeds \$10,000 or the value of the quantity acquired during the preceding fiscal year exceeded \$10,000; procuring solid waste management services in a manner that maximizes energy and resource recovery; and establishing an affirmative procurement program for procurement of recovered materials identified in the EPA guidelines. [78 FR 78608, Dec. 26, 2013, as amended at 79 FR 75885, Dec. 19, 2014]

Pursuant to Federal Rule (11) above, when federal funds are expended by TIPS OR ITS MEMBERS, TIPS OR ITS MEMBERS requires proposer certify that during the term of an award by the TIPS OR ITS MEMBERS resulting for this procurement process the vendor will be in compliance with mandatory standards and policies relating to Procurement of recovered materials which are listed above.

Does vendor agree they will comply? YES CDM Initial of Authorized Company Official

Company Name RAISE ENERGY SOLUTIONS

Print name of authorized representative CAROL D MCKOWN

Signature of authorized representative 

Date 1/15/2016

Signature above acknowledges all provisions in this four page document and the vendor/proposer/bidder responses herein to the 11 rules.