

VENDOR CONTRACT

Between Taylor Music, Inc. and
(Company Name)

THE INTERLOCAL PURCHASING SYSTEM (TIPS)
For
MUSICAL INSTRUMENTS AND SHEET MUSIC
#03052215

General Information

The vendor contract shall include the contract, the terms and conditions, special terms and conditions, any agreed upon amendments, as well as all of the sections of the solicitation and the awarded vendor's proposal. Once signed, if an awarded vendor's proposal varies or is unclear in any way from the TIPS contract, TIPS, at its sole discretion, will decide which provision will prevail. Other documents to be included are the awarded vendor's proposals, task orders, purchase orders and any adjustments which have been issued.

The following pages will constitute the contract between the successful vendors(s) and TIPS. Bidders shall state, in a separate writing, and include with their proposal response, any required exceptions or deviations from these terms, conditions, and specifications. If agreed to by TIPS, they will be incorporated into the final contract.

The Vendor Contract ("Contract") made and entered into by and between The Interlocal Purchasing System (hereinafter referred to as "TIPS" respectfully) a government cooperative purchasing program authorized by the Region VIII Education Service Center, having its principal place of business at 4845 US Hwy 271 North, Pittsburg, Texas 75686. This contract consists of the provisions set forth below, including provisions of all Attachments referenced herein. In the event of a conflict between the provisions set forth below and those contained in any Attachment, the provisions set forth shall control.

Definitions

PURCHASE ORDER is the TIPS member's approval providing the authority to proceed with the negotiated delivery order under the contract. Special terms and conditions as agreed to between the vendor and TIPS member will be added as addendums to the PO. Items such as certificate of insurance, bonding requirements, small or disadvantaged business goals are some of the addendums possible.

Contract – MUSICAL INSTRUMENTS AND SHEET MUSIC

PREMIUM HOURS are defined as those hours not included in regular hours or recognized holidays. Premium hours are to be approved by the TIPS member for each delivery order and noted in the delivery order proposal as a line item during negotiations.

REGULAR HOURS are defined as those hours between the hours of 7 AM and 6 PM Monday thru Friday.

Terms and Conditions

Freight

All deliveries shall be freight prepaid, F.O.B. destination and shall be included in all pricing offered unless otherwise clearly stated in writing.

Warranty Conditions

All supplies equipment and services shall include manufacturer's minimum standard warranty unless otherwise agreed to in writing. Vendor shall be an authorized dealer, distributor or manufacturer for all products. All equipment proposed shall be new unless clearly stated in writing.

Customer Support

The Vendor shall provide timely and accurate customer support to TIPS members. Vendors shall respond to such requests within one (1) working day after receipt of the request. Vendor shall provide training regarding products and services supplied by the Vendor unless otherwise clearly stated in writing at the time of purchase. (Unless training is a line item sold or packaged and must be purchased with product.)

Contracts

All contracts and agreements between Vendors and TIPS Members shall strictly adhere to the statutes that are set forth in the Uniform Commercial Code as most recently revised.

Contracts for purchase will normally be put into effect by means of a purchase order(s) executed by authorized agents of the participating government entities.

Davis Bacon Act requirements will be met when Federal Funds are used for construction and/or repair of buildings.

Tax exempt status

A taxable item sold, leased, rented to, stored, used, or consumed by any of the following governmental entities is exempted from the taxes imposed by this chapter:(1) the United States; (2) an unincorporated instrumentality of the United States; (3) a corporation that is an agency or instrumentality of the United States and is wholly owned by the United States or by another corporation wholly owned by the United States;(4) the State of Texas; (5) a Texas county, city, special district, or other political subdivision; or (6) a state, or a governmental unit of a state that borders Texas, but only to the extent that the other state or governmental unit

exempts or does not impose a tax on similar sales of items to this state or a political subdivision of this state. Texas Tax Code § 151.309.

Assignments of contracts

No assignment of contract may be made without the prior written approval of TIPS. Payment can only be made to the awarded Vendor or vendor assigned dealer.

Disclosures

1. Vendor affirms that he/she has not given, offered to give, nor intends to give at any time hereafter any economic opportunity, future employment, gift, loan, gratuity, special discount, trip, favor or service to a public servant in connection with this contract.
2. Vendor shall attach, in writing, a complete description of any and all relationships that might be considered a conflict of interest in doing business with participants in the TIPS program.
3. The vendor affirms that, to the best of his/her knowledge, the offer has been arrived at independently, and is submitted without collusion with anyone to obtain information or gain any favoritism that would in any way limit competition or give an unfair advantage over other vendors in the award of this contract.

Renewal of Contracts

The MUSICAL INSTRUMENTS AND SHEET MUSIC contract is for one (1) year with an option for renewal for 2 consecutive years. Total term of contract can be up to 3 years if sales are reported through the contract and both parties agree.

Shipments

The Vendor shall ship ordered products within five (5) working days after the receipt of the order. If a product cannot be shipped within that time, the Vendor shall notify TIPS and the requesting entity as to why the product has not shipped and shall provide an estimated shipping date, if applicable. TIPS or the requesting entity may cancel the order if estimated shipping time is not acceptable.

Invoices

The Vendor or vendor assigned dealer shall submit invoices, to the TIPS participant. Each invoice shall include the TIPS participant's purchase order number. The shipment tracking number or pertinent information for verification of TIPS participant receipt shall be made available upon request. The Vendor or vendor assigned dealer shall not invoice for partial shipments unless agreed to in writing in advance by TIPS and the TIPS participant.

Payments

The TIPS participant will make payments directly to the Vendor or vendor assigned dealer at net 30 days after receiving invoice.

Pricing

The Vendor contracts to provide pricing to TIPS and its participating governmental entities that is the lowest pricing available to like cooperative purchasing customers and the pricing shall remain so throughout the duration of the contract.

The Vendor agrees to promptly lower the cost of any product purchased through TIPS following a reduction in the manufacturer or publisher's direct cost to the Vendor. Price increases will be honored. However, the Vendor shall honor previous prices for thirty (30) days after written notification to TIPS of an increase.

All pricing submitted to TIPS shall include the Two Percent (2%) participation fee to be remitted to TIPS by the Vendor. Vendor will not show adding the 2% to the invoice presented to customer.

Participation Fees

Vendor or vendor assigned dealer contracts to pay 2% of all sales to TIPS on a monthly scheduled report. TIPS will email a Monthly Submission Report to each vendor. The Vendor or vendor assigned dealer is responsible for keeping record of all sales that go through the TIPS contract. Report may be sent to TIPS electronically while check for 2% is mailed. Failure to pay 2% participation fee will result in termination of contract.

Indemnity

- 1. Indemnity for Personality Contracts.** Vendor agrees to indemnify and hold harmless and defend TIPS, TIPS member(s), officers and employees, from and against all claims and suits for damages, injuries to persons (including death), property damages, losses, and expenses including court costs and attorney's fees, arising out of, or resulting from, Vendor's performance of this contract, including all such causes of action based upon common, constitutional, or statutory law, or based in whole or in part, upon allegations of negligent or intentional acts on the part of the Vendor, its officers, employees, agents, subcontractors, licensees, invitees, whether or not such claims are based in whole or in part upon the negligent acts or omissions of the TIPS, TIPS member(s), officers, employees, or agents.
- 2. Indemnity for Performance Contracts.** The Vendor agrees to indemnify and hold harmless and defend TIPS, TIPS member(s), officers and employees from and against all claims and suits for damages, injuries to persons (including death), property damages, losses, and expenses including court costs and attorney's fees, arising out of, or resulting from, Vendor's work under this contract, including all such causes of action based upon common, constitutional, or statutory law, or based in whole or in part, upon allegations

of negligent or intentional acts on the part of the Vendor, its officers, employees, agents, subcontractors, licensees, or invitees. Vendor further agrees to indemnify and hold harmless and defend TIPS, TIPS member(s), officers and employees, from and against all claims and suits for injuries (including death) to an officer, employee, agent, subcontractor, supplier or equipment lessee of the Vendor, arising out of, or resulting from, Vendor's work under this contract whether or not such claims are based in whole or in part upon the negligent acts or omissions of the TIPS, TIPS member(s), officers, employees, or agents.

Attorney's Fees--Texas Local Government Code § 271.159 is expressly referenced.

Pursuant to §271.159, TEXAS LOC. GOV'T CODE, in the event that any one of the Parties is required to obtain the services of an attorney to enforce this Agreement, the prevailing party, in addition to other remedies available, shall be entitled to recover reasonable attorney's fees and costs of court.

Multiple Vendor Awards

TIPS reserves the right to award multiple vendor contracts for categories when deemed in the best interest of the TIPS membership. Bidders scoring 80% or above will be considered for an award. Categories are established at the discretion of TIPS.

State of Texas Franchise Tax

By signature hereon, the bidder hereby certifies that he/she is not currently delinquent in the payment of any franchise taxes owed the State of Texas under Chapter 171, Tax Code.

Miscellaneous

The Vendor acknowledges and agrees that continued participation in TIPS is subject to TIPS sole discretion and that any Vendor may be removed from the participation in the Program at any time with or without cause. Nothing in the contract or in any other communication between TIPS and the Vendor may be construed as a guarantee that TIPS participants will submit any orders at any time. TIPS reserves the right to request additional proposals for items already on contract at any time.

Purchase Order Pricing/Product Deviation

If a deviation of pricing/product on a purchase order occurs, TIPS is to be notified within 24 hours of receipt of order.

Cancellation for non-performance or contract deficiency

TIPS may terminate any contract if TIPS Members have not used the contract, or if purchase volume is determined to be "low volume" in any 12-month period. TIPS reserves the right to cancel the whole or any part of this contract due to failure by awarded vendor to carry out any

obligation, term or condition of the contract. TIPS may issue a written deficiency notice to awarded vendor for acting or failing to act in any of the following:

- Providing material that does not meet the specifications of the contract;
- Providing work and/or material that was not awarded under the contract;
- Failing to adequately perform the services set forth in the scope of work and specifications;
- Failing to complete required work or furnish required materials within a reasonable amount of time;
- Failing to make progress in performance of the contract and/or giving TIPS reason to believe that awarded vendor will not or cannot perform the requirements of the contract; and/or
- Performing work or providing services under the contract prior to receiving a TIPS reviewed purchase order for such work.

Upon receipt of the written deficiency, awarded vendor shall have ten (10) days to provide a satisfactory response to TIPS. Failure to adequately address all issues of concern may result in contract cancellation. Upon cancellation under this paragraph, all goods, materials, work, documents, data and reports prepared by awarded vendor under this contract shall become the property of the TIPS Member on demand.

TIPS Member Purchasing Procedures

Purchase orders are issued by participating TIPS member to the awarded vendor indicating on the PO "Contract Number 03052215". Purchase Order is emailed to TIPS at tipspo@tips-usa.com.

- Awarded vendor delivers goods/services directly to the participating member.
- Awarded vendor invoices the participating TIPS member directly.
- Awarded vendor receives payment directly from the participating member.
- Awarded vendor reports sales monthly to TIPS (unless prior arrangements have been made with TIPS to report monthly).

Form of Contract

The form of contract for this solicitation shall be the Request for Proposal, the awarded proposal(s) and best and final offer(s), and properly issued and reviewed purchase orders referencing the requirements of the Request for Proposals. If a vendor submitting an offer requires TIPS and/or TIPS Member to sign an additional agreement, a copy of the proposed agreement must be included with the proposal.

Vendor contract documents: TIPS will review proposed vendor contract documents. Vendor's contract document shall not become part of TIPS's contract with vendor unless and until an authorized representative of TIPS reviews and approves it.

Licenses

Awarded vendor shall maintain in current status all federal, state and local licenses, bonds and permits required for the operation of the business conducted by awarded vendor. Awarded vendor shall remain fully informed of and in compliance with all ordinances and regulations pertaining to the lawful provision of services under the contract. TIPS reserves the right to stop work and/or cancel contract of any awarded vendor whose license(s) expire, lapse, are suspended or terminated.

Novation

If awarded vendor sells or transfers all assets or the entire portion of the assets used to perform this contract, a successor in interest must guarantee to perform all obligations under this contract. TIPS reserves the right to accept or reject any new party. A simple change of name agreement will not change the contractual obligations of awarded vendor.

Site Requirements (when applicable to service or job)

Cleanup: Awarded vendor shall clean up and remove all debris and rubbish resulting from their work as required or directed by TIPS Member. Upon completion of work, the premises shall be left in good repair and an orderly, neat, clean and unobstructed condition.

Preparation: Awarded vendor shall not begin a project for which TIPS Member has not prepared the site, unless awarded vendor does the preparation work at no cost, or until TIPS Member includes the cost of site preparation in a purchase order.

Site preparation includes, but is not limited to: moving furniture, installing wiring for networks or power, and similar pre-installation requirements.

Registered sex offender restrictions: For work to be performed at schools, awarded vendor agrees that no employee of a sub-contractor who has been adjudicated to be a registered sex offender will perform work at any time when students are or reasonably expected to be present. Awarded vendor agrees that a violation of this condition shall be considered a material breach and may result in the cancellation of the purchase order at the TIPS Member's discretion.

Awarded vendor must identify any additional costs associated with compliance of this term. If no costs are specified, compliance with this term will be provided at no additional charge.

Safety measures: Awarded vendor shall take all reasonable precautions for the safety of employees on the worksite, and shall erect and properly maintain all necessary safeguards for protection of workers and the public. Awarded vendor shall post warning signs against all hazards created by the operation and work in progress. Proper precautions shall be taken pursuant to state law and standard practices to protect workers, general public and existing structures from injury or damage.

Smoking

Persons working under contract shall adhere to local smoking policies. Smoking will only be permitted in posted areas or off premises.

Invoices

The awarded vendor shall submit invoices to the participating entity clearly stating "Per TIPS Contract". The shipment tracking number or pertinent information for verification shall be made available upon request.

Marketing

Awarded vendor agrees to allow TIPS to use their name and logo within website, marketing materials and advertisement. Any use of TIPS name and logo or any form of publicity, inclusive of press release, regarding this contract by awarded vendor must have prior approval from TIPS.

Supplemental agreements

The entity participating in the TIPS contract and awarded vendor may enter into a separate supplemental agreement to further define the level of service requirements over and above the minimum defined in this contract i.e. invoice requirements, ordering requirements, specialized delivery, etc. Any supplemental agreement developed as a result of this contract is exclusively between the participating entity and awarded vendor. TIPS, its agents, TIPS members and employees shall not be made party to any claim for breach of such agreement.

Legal obligations

It is the responding vendor's responsibility to be aware of and comply with all local, state and federal laws governing the sale of products/services identified in this RFP and any awarded contract thereof. Applicable laws and regulations must be followed even if not specifically identified herein.

Audit rights

Awarded Vendor shall, at their sole expense, maintain appropriate due diligence of all purchases made by TIPS Member that utilizes this Contract. TIPS and Region 8 ESC each reserve the right to audit the accounting for a period of three (3) years from the time such purchases are made. This audit right shall survive termination of this Agreement for a period of one (1) year from the effective date of termination. TIPS shall have authority to conduct random audits of Awarded Vendor's pricing that is offered to TIPS Members. Notwithstanding the foregoing, in the event that TIPS is made aware of any pricing being offered to eligible entities that is materially inconsistent with the pricing under this agreement, TIPS shall have the ability to conduct the audit internally or may engage a third-party auditing firm. In the event of an audit, the requested materials shall be provided in the format and at the location designated by Region 8 ESC or TIPS.

Force Majeure

If by reason of Force Majeure, either party hereto shall be rendered unable wholly or in part to carry out its obligations under this Agreement then such party shall give notice and fully particulars of Force Majeure in writing to the other party within a reasonable time after

occurrence of the event or cause relied upon, and the obligation of the party giving such notice, so far as it is affected by such Force Majeure, shall be suspended during the continuance of the inability then claimed, except as hereinafter provided, but for no longer period, and such party shall endeavor to remove or overcome such inability with all reasonable dispatch.

Services

When applicable, performance bonds will be required on construction or labor required jobs over \$100,000 and payment bonds on jobs over \$25,000 or awarded vendor will meet the TIPS member's local and state purchasing requirements. Awarded vendors may need to provide additional capacity as jobs increase. Bonds will not require that a fee be paid to TIPS. The actual cost of the bond will be a pass through to the TIPS member and added to the purchase order.

Scope of Services

The specific scope of work for each job shall be determined in advance and in writing between TIPS Member and Awarded vendor. It is okay if the TIPS member provides a general scope, but the awarded vendor should provide a written scope of work to the TIPS member as part of the proposal. Once the scope of the job is agreed to, the TIPS member will issue a PO with the estimate referenced as an attachment along with bond and any other special provisions agreed to for the TIPS member. If special terms and conditions other than those covered within this solicitation and awarded contracts are required, they will be attached to the PO and shall take precedence over those in the base contract.

Project Delivery Order Procedures

The TIPS member having approved and signed an interlocal agreement, or other TIPS membership document, may make a request of the awarded vendor under this contract when the TIPS member has services that need to be undertaken. Notification may occur via phone, the web, email, fax, or in person.

Upon notification of a pending request, the awarded vendor shall make contact with the TIPS member as soon as possible, but must make contact with the TIPS member within two working days.

Scheduling of Projects

Scheduling of projects (if applicable) will be accomplished when the TIPS member issues a purchase order that will serve as "the notice to proceed". The period for the delivery order will include the mobilization, materials purchase, installation and delivery, design, weather, and site cleanup and inspection. No additional claims may be made for delays as a result of these items. When the tasks have been completed the awarded vendor shall notify the client and have the TIPS member inspect the work for acceptance under the scope and terms in the PO. The TIPS member will issue in writing any corrective actions that are required. Upon completion of these items, the TIPS member will issue a completion notice and final payment will be issued.

Support Requirements

If there is a dispute between the awarded vendor and TIPS member, TIPS or its representatives will assist in conflict resolution or third party (mandatory mediation), if requested by either party. TIPS, or its representatives, reserves the right to inspect any project and audit the awarded vendors TIPS project files, documentation and correspondence.

Special Terms and Conditions

It is the intent of TIPS to contract with a reliable, high performance vendor to supply products and services to government and educational agencies. It is the experience of TIPS that the following procedures provide TIPS, the Vendor, and the participating agency the necessary support to facilitate a mutually beneficial relationship. The specific procedures will be negotiated with the successful vendor.

- **Contracts:** All vendor purchase orders must be emailed to TIPS at tipspo@tips-usa.com. Should an agency send an order direct to vendor, it is the vendor's responsibility to forward the order to TIPS at the email above within 24 business hours and confirm its receipt with TIPS.
 - **Promotion of Contract:** It is agreed that Vendor will encourage all eligible entities to purchase from the TIPS Program. Encouraging entities to purchase directly from the Vendor and not through TIPS contract is not acceptable to the terms and conditions of this contract and will result in removal of Vendor from Program. Vendor is expected to use marketing funds for the marketing and promotion of this contract.
 - **Daily Order Confirmation:** All contract purchase orders will be approved daily by TIPS and sent to vendor. The vendor must confirm receipt of orders to the TIPS member (customer) within 24 business hours.
 - **Vendor custom website for TIPS:** If Vendor is hosting a custom TIPS website, then updated pricing must be posted by 1st of each month.
 - **Back Ordered Products:** If product is not expected to ship within 3 business days, customer is to be notified within 24 hours and appropriate action taken based on customer request.
-

Check one of the following responses to the General Terms and Special Terms and Conditions:

We take no exceptions/deviations to the general and/or special terms and conditions.

(Note: If none are listed below, it is understood that no exceptions/deviations are taken.)

We take the following exceptions/deviations to the general and/or special terms and conditions. All exceptions/deviations must be clearly explained. Reference the corresponding general or special terms and conditions that you are taking exceptions/deviations to. The proposer must clearly state if you are adding additional terms and conditions to the general or special terms and conditions. Provide details on your exceptions/deviations below:

Contract – MUSICAL INSTRUMENTS AND SHEET MUSIC

Exceptions:

Prices in catalog include shipping delivery on orders over \$75.00. Orders under \$75

please add shipping (minimum shipping is \$12) Free shipping excludes cases and

furniture (Sherrard racks, Jarvis podiums and products, Command Director Showcase

Podiums and products). Call or email for additional discounts: mary@1800usaband.com

Please no "P" cards for orders over \$500.00

PLEASE SPECIFY CONTRACT TIPS-03052215 on PURCHASE ORDERS

The Interlocal Purchasing System (TIPS Cooperative) Supplier Response

Bid Information		Contact Information		Ship to Information
Bid Creator	Mr. David Mabe National Coordinator	Address	Region VIII Education Service Center 4845 US Highway 271 North Pittsburg, TX 75686	Address
Email	david.mabe@tips-usa.com	Contact	Mrs. Kim Thompson Coordinator of Office Operations	Contact
Phone	+1 (903) 243-4759	Department		Department
Fax	+1 (866) 749-6674	Building		Building
Bid Number	03052215	Floor/Room		Floor/Room
Title	Musical Instruments and Sheet Music	Telephone	+1 (866) 839-8477	Telephone
Bid Type	RFP	Fax	+1 (866) 929-4402	Fax
Issue Date	03/05/2015	Email	bids@tips-usa.com	Email
Close Date	4/17/2015 3:00:00 PM CT			
Need by Date				

Supplier Information

Company Taylor Music, Inc.
 Address 513 S Main
 Aberdeen, SD 57401

Contact
 Department
 Building
 Floor/Room

Telephone 1 (605) 225-1335
 Fax 1 (605) 225-2051
 Email

Submitted 4/17/2015 7:10:20 AM CT
 Total \$0.00

Signature Mary McKinney

Email mary@1800usaband.com

Supplier Notes

Bid Notes

Bid Activities

Bid Messages

Please review the following and respond where necessary

#	Name	Note	Response
1	Yes - No	Disadvantaged/Minority/Women Business Enterprise - D/M/WBE (Required by some participating governmental entities) Vendor certifies that their firm is a D/M/WBE? Vendor must upload proof of certification to the "Response Attachments" D/M/WBE CERTIFICATES section.	No
2	Yes - No	Highly Underutilized Business - HUB (Required by some participating governmental entities) Vendor certifies that their firm is a HUB? Vendor must upload proof of certification to the "Response Attachments" HUB CERTIFICATES section.	No
3	Yes - No	Certification of Residency (Required by the State of Texas) Company submitting bid is a Texas resident bidder?	No
4	Company Residence (City)	Vendor's principal place of business is in the city of?	Aberdeen
5	Company Residence (State)	Vendor's principal place of business is in the state of?	South Dakota
6	Felony Conviction Notice:	(Required by the State of Texas) My firm is, as outlined on PAGE 5 in the Instructions to Bidders document: (Questions 7 - 9)	(No Response Required)
7	Yes - No	A publicly held corporation; therefore, this reporting requirement is not applicable?	No
8	Yes - No	Is not owned or operated by anyone who has been convicted of a felony?	No
9	Yes - No	Is owned or operated by individual(s) who has/have been convicted of a felony? If answer is YES, a detailed explanation of the name(s) and conviction(s) must be uploaded to the "Response Attachments" FELONY CONVICTION section.	No
10	Pricing Information:	Pricing information section. (Questions 11 - 14)	(No Response Required)
11	Yes - No	In addition to the typical unit pricing furnished herein, the Vendor agrees to furnish all current and future products at prices that are proportionate to Dealer Pricing. If answer is NO, include a statement detailing how pricing for TIPS participants would be calculated in the PRICING document that is uploaded to the "Response Attachments" PRICING section.	Yes
12	Yes - No	Pricing submitted includes the 2% TIPS participation fee?	Yes
13	Yes - No	Vendor agrees to remit to TIPS the required 2% participation fee?	Yes
14	Yes - No	Additional discounts to TIPS members for bulk quantities or scope of work?	Yes
15	Start Time	Average start time after receipt of customer order is ____ working days?	10
16	Years Experience	Company years experience in this category?	59
17	Yes - No	The Vendor can provide services and/or products to all 50 US States?	Yes
18	States Served:	If answer is NO to question #17, please list which states can be served. (Example: AR, OK, TX)	

19	Company and/or Product Description:	This information will appear on the TIPS website in the company profile section, if awarded a TIPS contract. (Limit 750 characters.)	National Retailer of Band Instruments, Music Instruments, School Band Musical Instruments and Equipment, Percussion, Woodwind, Brass. Call or email for additional discounts and educational bid quote: mary@1800usaband.com
20	Resellers:	Does the vendor have resellers that it will name under this contract? (If applicable, vendor should download the Reseller/Dealers spreadsheet from the Attachments section, fill out the form and submit the document in the "Response Attachments" RESELLERS section.	No
21	Primary Contact Name	Primary Contact Name	Mary McKinney
22	Primary Contact Title	Primary Contact Title	Vice President of School Bid Sales
23	Primary Contact Email	Primary Contact Email	mary@1800usaband.com
24	Primary Contact Phone	Primary Contact Phone - Format (xxx) xxx-xxxx	800-872-2263
25	Primary Contact Fax	Primary Contact Fax - Format (xxx) xxx-xxxx	605-225-2051
26	Primary Contact Mobile	Primary Contact Mobile- Format (xxx) xxx-xxxx	NA
27	Secondary Contact Name	Secondary Contact Name	Lana Steger
28	Secondary Contact Title	Secondary Contact Title	Bid Sales
29	Secondary Contact Email	Secondary Contact Email	lana@1800usaband.com
30	Secondary Contact Phone	Secondary Contact Phone - Format (xxx) xxx-xxxx	800-872-2263
31	Secondary Contact Fax	Secondary Contact Fax - Format (xxx) xxx-xxxx	605-225-2051
32	Secondary Contact Mobile	Secondary Contact Mobile - Format (xxx) xxx-xxxx	NA
33	2% Contact Name	2% Contact Name	Roberta Thompson
34	2% Contact Email	2% Contact Email	bert@1800usaband.com
35	2% Contact Phone	2% Contact Phone - Format (xxx) xxx-xxxx	800-872-2263
36	Purchase Order Contact:	This person is responsible for receiving Purchase Orders from TIPS. (Questions 37 - 39)	(No Response Required)
37	Purchase Order Contact Name	Purchase Order Contact Name	Mary McKinney
38	Purchase Order Contact Email	Purchase Order Contact Email	mary@1800usaband.com
39	Purchase Order Contact Phone	Purchase Order Contact Phone - Format (xxx) xxx-xxxx	800-872-2263
40	Company Website	Company Website	www.1800usaband.com
41	Federal ID Number:	Federal ID Number also known as the Employer Identification Number.	46-0248482
42	Primary Address	Primary Address	513 S Main
43	Primary Address City	Primary Address City	Aberdeen
44	Primary Address State	Primary Address State	SD
45	Primary Address Zip	Primary Address Zip	57401

46 Search Words:

Please list search words to be posted in the TIPS database about your company that TIPS website users might search. Words may be product names, manufacturers, or other words associated with the category of award. YOU MAY NOT LIST NON-CATEGORY ITEMS. (Limit 500 words) (Format: product, paper, construction, manufacturer name, etc.)

Music, Band, Musical

47 Yes - No

Do you wish to be eligible to participate in a TIPS contract in which a TIPS member utilizes federal funds on contracts exceeding \$100,000? (Non-Construction) (If YES, vendor should download the Federal Funds Over \$100,000 Certification document from the Attachments section, fill out the form and submit the document in the "Response Attachments" FEDERAL FUNDS section.) (Vendor must also download the Suspension or Debarment Certificate document from the Attachments section, fill out the form and submit the document in the "Response Attachments" SUSPENSION OR DEBARMENT section.)

Yes

Line Items

Response Total: \$0.00

Provisions for purchase with federal funds for contracts exceeding \$100,000
These forms are for non-construction contracts

Many TIPS members (grantees and sub-grantees) purchase goods and services with federal funds. When a member engages a contract exceeding \$100,000 and paid with federal funds, provisions are triggered by various Code of Federal Regulations requirements. Primarily 34 CFR 80.36 from the Department of Education and 7 CFR 3015 & 3016 from the Department of Agriculture for School Lunch Program. There may be other Federal programs from time to time that are not enumerated above that may fund certain projects using outside vendors. These are not optional for the contracting entity and in order to spend the federal funds certain provision and certifications must be in place to ensure legal compliance.

If your company wishes to be eligible to participate in a TIPS contract in which a member utilizes federal funds on contracts exceeding \$100,000, you must complete the following forms can provide the certifications as required on the subsequent pages.

Do you wish to be eligible to participate in a TIPS contract in which a member utilizes federal funds on contracts exceeding \$100,000?

Check your response?

YES NO

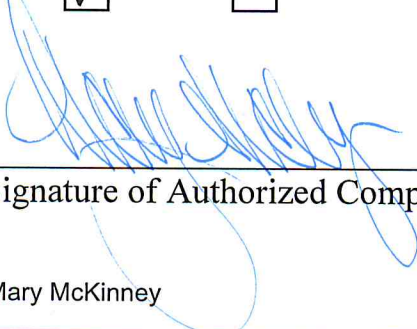

4/16/2015

Signature of Authorized Company Official

Date

Mary McKinney

Printed Name of Authorized Company Official

Taylor Music, Inc.

Company Name

Attach to this page a current W-9 form

Please complete the forms below

Legal Compliance

It is the proposing company's duty and responsibility to have knowledge of and be responsible for the compliance with all applicable laws, rules and regulations as they apply to this procurement process and any subsequent award. The vendor agrees to comply, in all relevant respects, with all Federal, State, and Local laws, rules and regulations related to the performance of services or supply of goods to TIPS or TIPS members?

Does vendor agree? YES mm Initial of Authorized Company Official

Non-Collusive Bidding Certificate

By submitting a proposal in response to a Request for Proposals or other procurement device containing this clause, you certify that you are authorized to certify to the following:

- 1) This bid or proposal has been independently arrived at without collusion with any other Bidder or with any Competitor;
- 2) This bid or proposal has not been knowingly disclosed and will not be knowingly disclosed, prior to the opening of bids, or proposals for this project, to any other Bidder, Competitor or potential competitor;
- 3) No attempt has been or will be made to induce any other person, partnership or corporation to submit or not to submit a bid or proposal;
- 4) The person signing this bid or proposal certifies that he has fully informed himself regarding the accuracy of the statements contained in this certification, and under the penalties being applicable to the Bidder as well as to the person signing in its behalf.

The vendor complied with #1 through 4 above? YES mm Initial of Authorized Company Official

SUSPENSION OR DEBARMENT CERTIFICATE

Non-Federal entities are prohibited from contracting with or making sub-awards under covered transactions to parties that are suspended or debarred or whose principals are suspended or debarred. Covered transactions include procurement for goods or services equal to or in excess of \$100,000.00. Contractors receiving individual awards for \$25,000.00 or more and all sub-recipients must certify that the organization and its principals are not suspended or debarred.

You certify that no suspension or disbarment is in place, which would preclude receiving a federally funded contract under the Federal OMB, A-102, common rules

The vendor has not been debarred? YES mm Initial of Authorized Company Official

Certification Regarding Lobbying

Applicable to Grants, Subgrants, Cooperative Agreements, and Contracts Exceeding \$100,000 in Federal Funds

Submission of this certification is a prerequisite for making or entering into this transaction and is imposed by section 1352, Title 31, U.S. Code. This certification is a material representation of fact upon which reliance was placed when this transaction was made or entered into. Any person who fails to file the required certification shall be subject to a civil penalty of not less than \$10,000 and not more than \$100,000 for each such failure.

The undersigned certifies, to the best of his or her knowledge and belief, that:

(1) No Federal appropriated funds have been paid or will be paid by or on behalf of the undersigned, to any person for influencing or attempting to influence an officer or employee of any agency, a Member of Congress, an officer or employee of congress, or an employee of a Member of Congress in connection with the awarding of a Federal contract, the making of a Federal grant, the making of a Federal loan, the entering into a cooperative agreement, and the extension, continuation, renewal, amendment, or modification of a Federal contract, grant, loan, or cooperative agreement.

(2) If any funds other than Federal appropriated funds have been paid or will be paid to any person for influencing or attempting to influence an officer or employee of any agency, a Member of Congress, an officer or employee of congress, or an employee of a Member of Congress in connection with this Federal grant or cooperative agreement, the undersigned shall complete and submit Standard Form-LLL, "disclosure Form to Report Lobbing," in accordance with its instructions.

(3) The undersigned shall require that the language of this certification be included in the award documents for all covered subawards exceeding \$100,000 in Federal funds at all appropriate tiers and that all subrecipients shall certify and disclose accordingly.

Taylor Music, Inc.

Name of Organization

513 S Main

Address of Organization

Mary McKinney, Vice President School Bid Sales

Name / Title of Submitting Official



Signature of Submitting Official

04-16-15

Signature Date

Provisions for purchase with federal funds for contracts exceeding \$100,000

Federal Rule (1) Administrative, contractual, or legal remedies in instances where contractors violate or breach contract terms, and provide for such sanctions and penalties as may be appropriate. (Contracts more than the simplified acquisition threshold)

Notice: Pursuant to Federal Rule (1) above, when federal funds are expended by TIPS Member, TIPS Member reserves all rights and privileges under the applicable laws and regulations with respect to this procurement in the event of breach of contract by either party.

Does vendor agree? YES mm Initial of Authorized Company Official

Federal Rule (2) Termination for cause and for convenience by the grantee or subgrantee including the manner by which it will be effected and the basis for settlement. (All contracts in excess of \$10,000)

Pursuant to Federal Rule (2) above, when federal funds are expended by TIPS Member, TIPS Member reserves the right to terminate any agreement in excess of \$10,000 resulting from this procurement process for cause after giving the vendor an appropriate opportunity and up to 30 days, to cure the causal breach of terms and conditions. TIPS Member reserves the right to terminate any agreement in excess of \$10,000 resulting from this procurement process for convenience with 30 days notice in writing to the awarded vendor. Any award under this procurement process is not exclusive and the District reserves the right to purchase goods and services from other vendors when it is in the best interest of the District.

Does vendor agree? YES mm Initial of Authorized Company Official

Federal Rule (7) Notice of awarding agency requirements and regulations pertaining to reporting.

Pursuant to Federal Rule (7) above, when federal funds are expended by TIPS Member, TIPS Member requires that the proposer certify that during the term of an award by the TIPS Member resulting from this procurement process the vendor will provide reports and documentation required by all applicable law and state and federal regulations upon request by the TIPS Member or any relevant state of federal agency.

Does vendor agree? YES mm Initial of Authorized Company Official

Federal Rule (8) Notice of awarding agency requirements and regulations pertaining to patent rights with respect to any discovery or invention which arises or is developed in the course of or under such contract.

Provisions for purchase with federal funds for contracts exceeding \$100,000

Pursuant to Federal Rule (8) above, when federal funds are expended by TIPS Member, TIPS Member shall address any requirements and regulations pertaining to patent rights with respect to any discovery or invention which arises or is developed in the course of or under such contract in the contract document and absent language to the contrary or if the contract silent on the subject, the District retains all rights thereto.

Does vendor agree? YES mm Initial of Authorized Company Official

Federal Rule (9) Awarding agency requirements and regulations pertaining to copyrights and rights in data.

Pursuant to Federal Rule (9) above, when federal funds are expended by TIPS Member, TIPS Member requires the proposer certify that during the term of an award by the TIPS Member resulting for this procurement process the vendor will surrender upon request any copyrighted materials owned by the TIPS Member but used in the awarded contract performance unless otherwise agreed in a written document by the parties. TIPS Member reserves the rights to all data created or provided to the vendor for the purpose of contract performance resulting for this procurement process and the vendor will surrender such data upon request unless otherwise agreed in a written document by the parties. If the contract is silent or not dispositive on the subject matter data or copyrights TIPS Member retains all rights in the data developed or gathered during the contract term.

Does vendor agree? YES mm Initial of Authorized Company Official

Federal Rule (10) Access by the grantee, the subgrantee, the Federal grantor agency, the Comptroller General of the United States, or any of their duly authorized representatives to any books, documents, papers, and records of the contractor which are directly pertinent to that specific contract for the purpose of making audit, examination, excerpts, and transcriptions.

Pursuant to Federal Rule (9) above, when federal funds are expended by TIPS Member, TIPS Member requires the proposer certify that during the term and after the awarded term of an award by the TIPS Member resulting for this procurement process the vendor will grant access by the grantee, the subgrantee, the Federal grantor agency, the Comptroller General of the United States, or any of their duly authorized representatives to any books, documents, papers, and records of the contractor which are directly pertinent to that specific contract for the purpose of making audit, examination, excerpts, and transcriptions.

Does vendor agree? YES mm Initial of Authorized Company Official

Provisions for purchase with federal funds for contracts exceeding \$100,000

Federal Rule (11) Retention of all required records for three years after grantees or subgrantees make final payments and all other pending matters are closed.

Pursuant to Federal Rule (11) above, when federal funds are expended by TIPS Member, TIPS Member requires the proposer certify that the awarded vendor retain of all required records for three years after grantees or subgrantees make final payments and all other pending matters are closed.

Does vendor agree? YES mm Initial of Authorized Company Official

Federal Rule (12) Compliance with all applicable standards, orders, or requirements issued under section 306 of the Clean Air Act (42 U.S.C. 1857(h)), section 508 of the Clean Water Act (33 U.S.C. 1368), Executive Order 11738, and Environmental Protection Agency regulations (40 CFR part 15). (Contracts, subcontracts, and subgrants of amounts in excess of \$100,000)

Pursuant to Federal Rule (12) above, when federal funds are expended by TIPS Member, TIPS Member requires the proposer certify that in performance of the contracts, subcontracts, and subgrants of amounts in excess of \$100,000, the vendor will be in compliance with all applicable standards, orders, or requirements issued under section 306 of the Clean Air Act (42 U.S.C. 1857(h)), section 508 of the Clean Water Act (33 U.S.C. 1368), Executive Order 11738, and Environmental Protection Agency regulations (40 CFR part 15).

Does vendor agree? YES mm Initial of Authorized Company Official

Federal Rule (13) Mandatory standards and policies relating to energy efficiency which are contained in the state energy conservation plan issued in compliance with the Energy Policy and Conservation Act (Pub. L. 94-163, 89 Stat. 871).

Pursuant to Federal Rule (13) above, when federal funds are expended by TIPS Member, TIPS Member requires proposer certify that during the term of an award by the TIPS Member resulting for this procurement process the vendor will be in compliance with mandatory standards and policies relating to energy efficiency which are contained in the state energy conservation plan issued in compliance with the Energy Policy and Conservation Act (Pub. L. 94-163, 89 Stat. 871).

Does vendor agree? YES mm Initial of Authorized Company Official

FELONY CONVICTION NOTICE FORM

Statutory citation covering notification of criminal history of contractor is found in the Texas Education Code §44.034.

FELONY CONVICTION NOTIFICATION

State of Texas Legislative Senate Bill No. 1, Section 44.034, Notification of Criminal History, Subsection (a), states "a person or business entity that enters into a contract with a school district must give advance notice to the district if the person or an owner or operator of the business entity has been convicted of a felony. The notice must include a general description of the conduct resulting in the conviction of a felony".

Subsection (b) states "a school district may terminate a contract with a person or business entity if the district determines that the person or business entity failed to give notice as required by Subsection (a) or misrepresented the conduct resulting in the conviction. The district must compensate the person or business entity for services performed before the termination of the contract".

THIS NOTICE IS NOT REQUIRED OF A PUBLICLY-HELD CORPORATION

I, the undersigned agent for the firm named below, certify that the information concerning notification of felony convictions has been reviewed by me and the following information furnished is true to the best of my knowledge.

VENDOR'S NAME: Taylor Music, Inc.

AUTHORIZED COMPANY OFFICIAL'S NAME: Mary McKinney

A. My firm is a publicly-held corporation, therefore, this reporting requirement is not applicable.

Signature of Company Official: _____

B. My firm is not owned nor operated by anyone who has been convicted of a felony.

Signature of Company Official: _____

C. My firm is owned or operated by the following individual(s) who has/have been convicted of a felony.

Name of Felon(s): _____
(attach additional sheet if necessary)

Details of Conviction(s): _____
(attach additional sheet if necessary)

Signature of Company Official: _____

SUSPENSION OR DEBARMENT CERTIFICATE

Non-Federal entities are prohibited from contracting with or making sub-awards under covered transactions to parties that are suspended or debarred or whose principals are suspended or debarred. Covered transactions include procurement for goods or services equal to or in excess of \$100,000.00. Contractors receiving individual awards for \$25,000.00 or more and all sub-recipients must certify that the organization and its principals are not suspended or debarred.

You certify that no suspension or disbarment is in place, which would preclude receiving a federally funded contract under the Federal OMB, A-102, common rules

Information may be found at <https://www.sam.gov/index.html>

Has the vendor been debarred form participation in Federal funds contracts?

NO Initial of Authorized Company Official

YES ^{mm} Initial of Authorized Company Official

Company Official: Mary McKinney 

Company: Taylor Music, Inc.

CONTRACT Signature Form

The undersigned hereby proposes and agrees to furnish goods and/or services in compliance with the terms, specifications and conditions at the prices quoted unless noted in writing. The undersigned further certifies that he or she is an authorized agent of the company and has authority to negotiate and contract for the company named below.

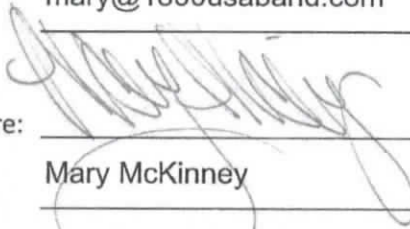
Company Name: Taylor Music, Inc.
Mailing Address: 513 S Main
City: Aberdeen
State: SD
Zip: 57401
Telephone Number: (605) 225-1335
Fax Number: (605) 225-2051
Email Address: mary@1800usaband.com
Authorized Signature: 
Printed Name: Mary McKinney
Position: Vice President of School Bid Sales

This contract is for a total TERM of one year with the option of two additional years. Vendors shall honor the participation fee for any sales made based on the TIPS contract. Failure to pay the fee will be grounds for termination of contract and will affect the award of future contracts.

Blende McNatt 5-22-15
TIPS Authorized Signature Date

David Wayne Fitts 5-22-15
Approved by Region VIII ESC Date

References

**** Must have at least 3 References. References must be School, City, County, University, State Agency or Other Government.**

Organization	City	State	Contact Name	Contact Phone
Arlington ISD	Arlington	TX	Lynda Hopp, Purchasing Specia	682-867-7420
Texas State University – San M	San Marcos	TX	Cindy Dean, Admin Asst.	512-245-3377
Cypress-Fairbanks ISD	Houston	TX	Nancy Dunn – Buyer	281-897-4386
Birdville ISD	North Richland Hills	TX	Kathy Handler, Fine Arts Adm. A	817-547-5921

1-800-872-2263
www.taylormusic.com



taylor music inc.

accessories 2015



FREE SHIPPING
ON ORDERS OVER \$75.00
exclusions may apply

Table of Contents

Questions?

1-800-872-2263

Or visit us on the web:
www.taylormusic.com

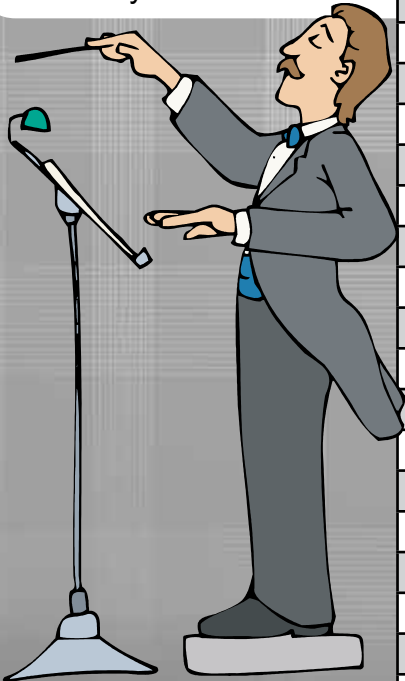

**Thank You
 for Shopping
 with Taylor Music**



FREE SHIPPING
 U.S. Contiguous
**ON ACCESSORY
 ORDERS OVER
 \$75**
 (Exclusions are noted)

1.	2015 Accessory Catalog	43.	Percussion Sound Effects
2.	Table of Contents	44.	Percussion Sound Effects
3.	Reeds	45.	Bongos, Cajons, Congas, Timbales
4.	Brass Mouthpieces	46.	Zildjian Cymbals
5.	Reed Mouthpieces	47.	Zildjian Cymbals
6.	Ligatures, Mouthpiece Accessories	48.	Sabian Cymbals
7.	Caps, Care Supplies, Mouthpiece Puller	49.	Cymbal Accessories, Crotales
8.	Care Kits, Cleaning Supplies	50.	Gongs, Gong Stands
9.	Batons, Recorders, Swabs	51.	Accessory Trays
10.	Sousa Neck, Bits, Protecto Pads	52.	Percussion Mounts, Stands
11.	Lubricants/Oils	53.	Bass Drum Stands
12.	Lubricants/Oils, Disinfectant	54.	Percussion Stands
13.	Neck Straps	55.	Drum Thrones, Pedals
14.	Repair Kits	56.	Percussion Stands
15.	Lyres, Marching Folios	57.	Movers & Carts
16.	Mutes	58.	Movers & Carts
17.	Method Books	59.	Podiums
18.	Method Books, Folders	60.	Podiums
19.	PA System, Mic	61.	Drum Parts
20.	Metronomes, Microphones	62.	Drum Hoops, Tuning Keys
21.	Mics, Pitchpipe, Tuners	63.	Timpani Gauges, Covers
22.	Orchestra Supplies	64.	Cases: Woodwind
23.	Orchestra Supplies	65.	Cases: Woodwind
24.	Music Stand, Lights, pBones, pTrumpets	66.	Cases: Woodwind, Strings
25.	Stands, Stand Carts	67.	Cases: Brasswind
26.	Storage Racks, Instrument Stands	68.	Cases: Brasswind
27.	Instrument Stands	69.	Cases: Brasswind
28.	Remo Drumheads	70.	Cases: Brasswind
29.	Remo Drumheads	71.	Cases: Brasswind
30.	Evans Drumheads	72.	Cases: Percussion
31.	Drumheads, Practice Pads	73.	Cases, Covers: Percussion
32.	Drumsticks	74.	Cases & Bags: Cymbals, Drum Set
33.	Mallets	75.	Stick/Mallet Bags
34.	Mallets	76.	Beginner Program Prices
35.	Mallets, Accent Sticks	77.	Beginner Program Contract
36.	Mallets	78.	Sousaphone Trading
37.	Boomwhackers	79.	Even Steven Trading
38.	Percussion Sound Effects	80.	Contact Information / Policies
39.	Percussion Sound Effects	81.	Index
40.	Percussion Sound Effects	82.	Index
41.	Percussion Sound Effects	83.	pBones
42.	Percussion Sound Effects	84.	Hot Buy Cases

Rico Traditional Reeds

Instrument	Strength	Box	List	Sale
Eb Clarinet	2, 2.5, 3	10	\$39.50	\$21
Bb Clarinet	2, 2.5, 3, 3.5	10	\$31.25	\$17
Bass Clarinet	2, 2.5, 3	10	\$59.50	\$30
Contra Clarinet	2, 2.5, 3	10	\$90.00	\$49
Soprano Sax	2, 2.5, 3, 3.5	10	\$41.25	\$22
Alto Sax	2, 2.5, 3, 3.5	10	\$44.00	\$24
Tenor Sax	2, 2.5, 3, 3.5	10	\$58.50	\$30
Bari Sax	2, 2.5, 3	10	\$75.00	\$40

Instrument	Strength	Box	List	Sale
Bb Clarinet	2, 2.5, 3, 3.5	25	\$72.25	\$39
Alto Clarinet	2, 2.5, 3	25	\$108.00	\$58
Bass Clarinet	2, 2.5, 3	25	\$139.50	\$73
Alto Sax	2, 2.5, 3, 3.5	25	\$109.00	\$58
Tenor Sax	2, 2.5, 3, 3.5	25	\$145.00	\$75
Bari Sax	2, 2.5, 3	25	\$182.00	\$93

Rico Traditional Alto Sax Reeds

Sleeved Reeds; Bulk Packaging

Model	Strength	Sale
RAS-50-2	2 (50 Reeds per bag)	\$99

Limited Quantities

Rico Plasticover Reeds

(Box of 5)

Professional quality cane. Coated with plastic to resist changes in moisture & climate; provides durability & clear tone.

Instrument	Strength	List	Sale
Bb Clarinet	2, 2.5, 3	\$30	\$16
Alto Sax	2, 2.5, 3	\$36	\$19
Tenor Sax	2, 2.5, 3	\$47	\$25
Bari Sax	2, 2.5, 3	\$55	\$29

Lavoz Reeds

(Box of 10)

Instrument	Strength	List	Sale
Bb Clarinet	MS, M, MH	\$33.50	\$18
Bass Clarinet	MS, M, MH	\$62.50	\$32
Soprano Sax	MS, M, MH	\$43.50	\$23
Alto Sax	MS, M, MH	\$48.00	\$25
Tenor Sax	MS, M, MH	\$63.00	\$33
Bari Sax	MS, M, MH	\$85.00	\$44

Frederick L. Hemke Reeds

(Box of 5)

Instrument	Strength	List	Sale
Soprano Sax	2, 2.5, 3, 3.5	\$22.50	\$12
Alto Sax	2, 2.5, 3, 3.5, 4	\$24.25	\$13
Tenor Sax	2, 2.5, 3, 3.5	\$34.75	\$18
Bari Sax	2, 2.5, 3, 3.5	\$61.75	\$32

Vandoren Traditional Reeds

Instrument	Strength	Box	List	Sale
Eb Clarinet	2, 2.5, 3	10	\$43.99	\$26
Bb Clarinet	2, 2.5, 3, 3.5, 4	10	\$43.99	\$26
Alto Clarinet	2, 2.5, 3	10	\$55.99	\$32
Bass Clarinet	2, 2.5, 3, 3.5	5	\$40.99	\$24
Contra Bass	2, 3	5	\$96.99	\$56
Soprano Sax	2, 2.5, 3, 3.5	10	\$43.99	\$26
Alto Sax	2, 2.5, 3, 3.5, 4	10	\$55.99	\$32
Tenor Sax	2, 2.5, 3, 3.5, 4	5	\$40.99	\$24
Bari Sax	2, 2.5, 3, 3.5, 4	5	\$74.99	\$44

Vandoren V Series Reeds

V12 & V16 Series are specifically designed for advanced players. Made out of thicker wood; approx 1/2 strength harder than traditional reeds.

Vandoren V12 Reeds

(Box of 5)

Instrument	Strength	List	Sale
Bb Clarinet	2.5, 3, 3.5, 4, 4.5	\$57.99	\$34

Vandoren V16 Reeds

Instrument	Strength	Box	List	Sale
Alto Sax	2.5, 3, 3.5, 4	10	\$55.99	\$32
Tenor Sax	2.5, 3, 3.5, 4	5	\$40.99	\$24

Mitchell Lurie Reeds

(Box of 10)

Instrument	Strength	List	Sale
Bb Clarinet	2, 2.5, 3, 3.5, 4, 4.5	\$34.75	\$18

Jones Oboe & Bassoon Reeds

Handcrafted French cane reed.

Regular Series

Instrument	Model	Strength
Oboe	JROB	MS, Med, MH
Bassoon	JRBA	MS, Med, MH

\$13 Each
\$33 Set of 3

Artist Series

Instrument	Model	Strength
Oboe	JAOB	MS, Med, MH
Bassoon	JABA	MS, Med, MH

\$18 Each
\$48 Set of 3

Fox Renard Oboe & Bassoon Reeds

Made from select cane.

Fox's most popular reed for students.

Instrument	Model	Strength
Oboe	1008-M	Medium
Bassoon	1006-M	Medium

\$13 Each
\$33 Set of 3

Selmer Plastic Oboe & Bassoon Reeds

Plastic reeds eliminate excess moisture found in cane reeds.

Instrument	Model	Strength
Oboe	SP-OB	Soft, Med, Hard
Bassoon	BP-BA	Soft, Med, Hard

\$18 Each
\$48 Set of 3

Universal Brass Mouthpieces

Silver plated, medium cup.



Instrument	Model	Size	Sale
Cornet	UN-CO-7C	7C	\$18
Trumpet	UN-TP-3C	3C	\$18
Trumpet	UN-TP-7C	7C	\$18
French Horn	UN-FH-11	11	\$19
Mrcng Mellophone	ME6V	6	\$25
Trombone, Tenor	UN-TB-12C	12C	\$25
Trombone, Tenor	UN-ET-65AL	6.5AL	\$33
Trombone, Bass	UN-EB-65AL	6.5AL	\$33
Tuba/Sousa	UN-TU-24AW	24AW	\$45

Conn Helleberg Tuba/Sousa Mouthpieces

120S Standard

Produces a very deep organ like tone with excellent volume. Deep cup. Medium round rim shape. List \$120

\$79



1207B 7B

Slightly shallower cup. Produces a brighter tone with more volume. Medium deep cup. Medium round rim shape. List \$120

\$79



Holton Farkas French Horn Mouthpieces

Sizes/Model

HF-MC: Medium Cup

HF-DC: Deep Cup

HF-MDC: Medium Deep Cup

Standard size for all Farkas French horns

List \$83

\$59

Miraphone Tuba Mouthpieces

Offers players a great sound with less effort.

TU25 Rose Orchestra **\$120**

Cup Depth: Very Deep; 45.7 mm (1.799")

Cup Diameter: 32.7 mm (1.287")

Silver finish. 8.2mm Bore (0.323")

TU29 BBb/CC **\$99**

Cup Depth: Very Deep; 44.1 mm (1.736")

Cup Diameter: 33 mm (1.299")

Silver finish. 8.2mm Bore (0.323")

TU33 BBb/CC **\$99**

Cup Depth: Very Deep; 44.1 mm (1.736")

Cup Diameter: 33 mm (1.299")

Silver finish. 8.4mm (0.331")



Bach Mouthpieces

Standard, Silver plated.

*Other Sizes Available as Factory Order



Instrument	Model/Description	List	Sale
Cornet	349-3C: Medium wide 349-5C: Medium wide. Well rounded, fairly flat 349-7C: Medium wide. Medium sharp inside, well rounded edge	\$84	\$56
Trumpet	351-1C: Medium wide. Medium cup. Large diameter. 351-1 1/2C: Medium wide. Not too sharp 351-3C: Medium wide 351-5C: Medium wide. Well rounded, fairly flat 351-7C: Medium wide. Medium sharp inside, well rounded edge 351-10 1/2C: Medium wide. Medium deep cup	\$84	\$56
Flugelhorn	342-3C: Medium wide. Fairly large cup, good all around use 342-5C: Medium wide. Well rounded, fairly flat	\$84	\$56
French Horn	336-11: Medium wide 336-16: Medium	\$77	\$51
Trombone /Baritone	350-6 1/2AL: Medium deep cup. Medium wide, well rounded 350-7C: Medium shallow cup. Medium wide, not too sharp 350-12C: Medium cup. Medium wide	\$106	\$71
Bass Trombone	341-1 1/2G: Medium wide, deep cup. Well rounded edge 341-6 1/2AL: Medium deep cup. Medium wide, well rounded	\$109	\$73
Tuba / Sousa	335-18: Medium cup. Medium wide 335-22: Medium deep cup. Medium wide 335-24AW: Deep cup. Wide, well-rounded	\$135	\$90

Schilke Mouthpieces

Standard, Most Popular



Instrument	Model/Description	List	Sale
Trumpet	14A4A: Shallow A cup, semi-flat #4 rim. Tight A backbore 14: Standard rim, cup & backbore. All-around playing 15: Excellent all-around use. Free blowing sound	\$80	\$48
French Horn	30C2: Excellent response in low & high range Recommended for professionals and beginners	\$80	\$48
Trombone (Tenor Shank)	51D-SM: Very large D cup. Excellent for strong player Suited for Euphonium, full dark tone 50C4-SM: Medium deep cup, Medium wide rim	\$103	\$62
Trombone (Bass Shank)	51D-LG: Very large D cup. Excellent for strong player Suited for Euphonium, full dark tone 50C4-LG: Medium deep cup, Medium wide rim	\$103	\$62
Tuba / Sousa	66: Designed from original Helleberg Small inside diameter	\$150	\$90

*Other Sizes Available as Factory Order

Yamaha Mouthpieces

Instrument	Model/Description	List	Sale
Trumpet	YAC-TR11C4: 16.46mm inner diameter, semi flat rim, standard cup depth. Good for all round playing. Standard for beginners & advanced players. YAC-TR14B4: 16.85mm inner diameter, semi flat rim, semi shallow cup depth. Relatively large rim diameter & shallow cup. Outstanding for all musical genres.	\$61.99	\$36
French Horn	YAC-HR30C4: 17.28mm inner diameter, semi flat rim, standard U cup depth: Medium inner rim diameter & U cup for fast response.	\$61.99	\$36
Trombone /Baritone	YAC-SL45C2: Small Shank. 24.26mm inner diameter, semi rounded rim, standard cup depth. Small inner rim diameter. Easy playability, bright tone. YAC-SLL48: Large Shank. 25.25mm inner diameter, standard rim, semi deep cup. Well-balanced rim and cup with a fairly narrow backbore.	\$74.99	\$44
Tuba/Sousa	YAC-BB67C4: 32.06mm inner diameter, semi flat rim, semi shallow cup depth. Large inner rim diameter with a shallow cup. Easy playability with a bright tone.	\$105.99	\$60



Bundy Student Mouthpieces

Medium facing only. Durable plastic material. Standard equipment on Student Bundy models.

Instrument	Model	Sale
Bb Clarinet	BP201	\$16
Alto Sax	BP402	\$18
Tenor Sax	BP404	\$24

Selmer George M Bundy Signature Series Mouthpieces

Molded Hard rubber. Medium facing only. Good student mouthpieces with professional features.

Instrument	Model	List	Sale
Alto Clarinet	B202	\$87	\$48
Bass Clarinet	B203	\$100	\$56
Contra Alto Clarinet	B204	\$112	\$63
Alto Sax	BR402	\$78	\$44
Tenor Sax	BR404	\$94	\$52
Bari Sax Streamline w/Cap & Lig	BX405	\$151	\$85

Selmer USA Alto Sax Mouthpieces

SP402 Medium facing only. Made of durable plastic material. Original equipment for Selmer USA AS300 Alto Sax.

\$13 Each
\$66 Set of 6
\$111 Dozen



Buescher USA Alto Sax Mouthpieces

BU402-10 Made from molded durable plastic material. Medium facing. Good for beginning students.

\$10 Each
\$55 Set of 6
\$99 Dozen



Selmer Paris Mouthpieces

Made from hard rubber.



Bb Clarinet Mouthpieces

Instrument	Model	List	Sale
Bb Clarinet	201-HS*	\$194.95	\$75

While Supplies Last



Harmony Clarinet Mouthpieces

Instrument	Model	List	Sale
Alto Clarinet	202-C*	\$360	\$175
Bass Clarinet	S203FOCUS 1.90mm similar to C*	\$440	\$218
Bass Clarinet	S203CONCEPT 2.15mm Large opening, powerful sound	\$440	\$218



S80 Series Saxophone Mouthpieces

Instrument	Model	List	Sale
Soprano Sax	S401-C*	\$225	\$119
Alto Sax	S402-C*	\$281	\$149
Tenor Sax	S404-C*	\$326	\$179
Bari Sax	S405-C*	\$461	\$249

Yamaha Mouthpieces

Molded plastic. Standard medium facing. Well balanced clear and focused tone. Ideal for beginner or professional player.

Instrument	Model	List	Sale
Bb Clarinet	YAC-12664C	\$55.99	\$30
Bass Clarinet	YAC-12764C	\$61.99	\$35
Alto Sax	YAC-12864C	\$46.99	\$25
Tenor Sax	YAC-12914C	\$48.99	\$27
Bari Sax	YAC-12955C	\$77.99	\$43



Debut Mouthpieces by Clark Fobes

Step-up; Molded acrylic; hand finished



Instrument	Model	List	Sale
Bb Clarinet	DECL CF+ (.040") facing	\$39.50	\$28
Bass Clarinet	DEBC CF, 24mm length 1.70mm tip opening	\$75.00	\$49
Alto Sax	DEAS Medium close facing	\$44.00	\$30
Tenor Sax	DETS Medium open facing	\$47.00	\$33
Bari Sax	DEBS Medium close facing	\$105.00	\$69



Vandoren Bb Clarinet Mouthpieces

Black ebonite, hard rubber material. Made in Paris

Traditional Series List \$172.99

Model	Sale
VD-B45 (CM308) Universal Intermediate 119.5mm tip opening; Medium Long facing	\$95
VD-5RV (CM301) Professional 106.5mm tip opening; Medium Short facing	\$95
VD-5RVL (CM301) More Open, Longer Facing 109+ mm tip opening; Medium facing	\$95

Profile 88 Series List \$184.99

Model	Sale
VD-M13 (CM4138) Rich, Colorful Sound Precise Response 100.5mm tip opening; Long facing	\$99

C Robert Scott Clarinet Barrel

SCB (66MM) Designed for all Bb Clarinets. Works best with Buffet R13 Clarinet. Internal reverse taper (hourglass shape) helps intonation. Produces warm, dark, focused & rich tone quality.

\$77





Beginner Woodwind Mouthpiece Kit

Mouthpiece kits have everything you need in one smart package. A great value for your clarinet and saxophone students!

Kits Include

- Student Plastic Mouthpiece
- Metal Ligature & Plastic Mouthpiece Cap
- Reedgard II (holds 2 reeds)
- Mouthpiece Saver
- 2 Rico #2 Reeds
- Cork Grease Tube

- TMCLK Clarinet Kit **\$26**
- TMASK Alto Sax Kit **\$28**
- TMTSK Tenor Sax Kit **\$32**

Rico Plastic Reedgard

Plastic reed holder fits and protects woodwind reeds.



Reedgard II (Holds 2 Reeds)

RG2CLA Clarinet/Alto Sax (II)

RG2TBS Tenor/Bari Sax (II) **\$3**

RG20B Oboe (II)

Reedgard IV (Holds 4 Reeds)

Clarinet/Alto Sax

RG4CLA (IV)

Tenor/Bari Sax **\$5**

RG4TBS (IV)

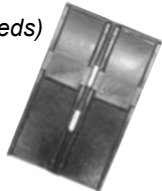

Brasswind Mouthpiece Adaptor

Universal mouthpiece adaptors for cornet, French horn, tenor mouthpieces.

34B Bass Trombone **\$14**
(adapts tenor mouthpiece)

36E English Shank Baritone/Trombone
(adapts Tenor Baritone mouthpiece)

38F Trumpet/Mellophone
(adapts French Horn mouthpiece)

40C Trumpet
(adapts cornet mouthpiece)



American Plating Ligatures

332N (Nickel) Bb Clarinet

\$5 Each
\$24 Set of 6
\$44 Dozen

530N (Nickel) Alto Clarinet **\$8**

531N (Nickel) Bass Clarinet **\$8**

337G (Lacquer) Bari Sax **\$9**



Selmer Ligatures

Original equipment on Selmer (USA) and Bundy II woodwinds.

1739 (Brass) Soprano Sax **\$7**

1698N (Nickel) Contrabass **\$15**



Selmer Metal Sax Ligatures

SASL Alto Sax, Gold Lacquer

STSL Tenor Sax, Gold Lacquer

\$4 Each
\$22 Set of 6 (Any Mix)
\$33 Set of 12 (Any Mix)

Leblanc D Bonade Inverted Ligatures



Instrument	Model	List	Sale
Bb Clarinet	2250UN Nickel	\$35	\$21
Bass Clarinet	2253UN Nickel	\$45	\$27
Soprano Sax	2257US Gold Lacquer	\$37	\$22
Alto Sax	2254UG Gold Lacquer	\$37	\$22
Tenor Sax	2255UG Gold Lacquer	\$43	\$26

Rovner Neoprene Ligatures

Neoprene impregnated polyester fabric to improve tone, response and provide greater playing ease. Includes mouthpiece cap.

Dark ligatures **\$26**

Most popular. Provides big centered tone.

Light ligatures

Free playing with broader more open tone for gusty, contemporary styles of playing.

Instrument	Model
Bb Clarinet	1R Dark L5 Light
Bass Clarinet	3RL Dark
Alto Sax	1RL Dark L6 Light
Tenor Sax	2R Dark L8 Light
Bari Sax	3R Dark L9 Light



FREE SHIPPING
U.S. Contiguous

ON ACCESSORY
ORDERS OVER

\$75

(Exclusions are noted)

B.E.R.P. Buzz Extension Resistance Piece

Allows player to buzz into mouthpiece while practicing fingerings. Attaches to open end of leadpipe and clamps on. Allows player to practice in silence. Builds embouchure. Increases greater intonation & range.

Options:

- BERP1 French Horn **\$16**
- BERP3 Trumpet
- BERP4 Small Shank Trombone
- BERP5 Large Shank Trombone
- BERP6 Tuba



**Luyben
Bb Clarinet
Cap & Ligature**

2215 Cap and Ligature made of black plastic material.

\$12



**Plastic
Mouthpiece Caps**

Black plastic cap designed to protect your reed & mouthpiece tip when not in use.

324P Bb Clarinet

\$3

521P Bass Clarinet

\$4

326P Alto Sax

\$3

328P Tenor Sax

\$4



Any Mix

\$16 Set of 6

\$28 Dozen

Metal Mouthpiece Caps

Protect your reed and mouthpiece when not being played.

Nickel Plated

1712N Alto Clarinet

\$8

1699N Contra Alto

\$20

Brass Lacquered

323G Soprano Sax

\$7

329G Bari Sax

\$15



**Selmer
Alto/Tenor Sax
End Plug**

Molded, high-impact plastic. Keep the neck receiver and octave key of your saxophone in perfect working condition with an end plug.

1723 Alto Sax

\$5

1724 Tenor Sax

\$5



Bobcat Mouthpiece Puller

BMP Removes stuck mouthpieces from brass instrument in seconds. Designed to last. Completely self-contained tool. No loose parts. Can be carried in tool box or instrument case. Simple to operate. List \$94

\$55



**Runyon
Mouthpiece Savers**

Set of 2 Patches

393BK Black

Cushioned for sensitive teeth

393CL Clear

Hard patch for standard feel

\$4 Set of 2



**Runyon Sax
Palm Key Risers**

397 Set of 3

Saxophone palm key risers. Easily slides onto palm keys making keys easier to reach.

\$6 Set of 3



**Runyon
Clarinet/Oboe
Thumb Saver**

395 Slides on metal thumb rest of most clarinets & oboes. Curved bottom surface fits the contour of the player's thumb. Helps prevent soreness and allows for more playing time.

**\$3.50 Each
\$13 Set of 6**

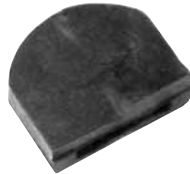

**Runyon
Saxophone
Thumb Saver**

396 Saxophone thumb saver slides on metal thumb rest of all saxophones. Provides comfort, non-slip grip.

\$6



**Lip Ease
Teeth Cushion**

2428 for Woodwind or Brass Players. Helps with lip comfort & endurance. 30" Strip.

\$8



**Universal Sax Neck
Cleaning Coil/Snake**

SNC Sax Neck

Designed to keep saxophone necks clean and free from buildup.

\$5



Bore Cleaning Coil/Snake

Designed to keep bores clean & free from buildup.

629 Trumpet

\$7

630 Trombone

\$7

631 French Horn

\$8

392B Baritone

\$8



**Selmer
Cleaning Cloth**

2976 Bleached cotton, lint free. Size 10 x 17.5

\$4



**Selmer
Specially Treated
Polishing Cloths**

Specially treated, lint free, non-greasy, non-abrasive cloth leaves an invisible coating. Guards against fingerprints and damaging perspiration. Used dry, without other cleaning agents.

2952 Brass

\$5

2955 Silver

\$5



Brace Lip Protector

2426JT Plastic strip fits over braces to stop pain.

\$12 Set



Brace Lip Guard

BG3 Lip protection for musicians and all brace patients. Putty material conforms to teeth. Quick, dependable & reusable orthodontic shield.

\$16





Cleaning Rods

Lightweight yet sturdy. Sized just right to make cleaning instruments an easy, trouble free task.

- 370F Flute** **\$4**
- 370P Piccolo** **\$3**
- 370T Trumpet/Cornet** **\$4**
- 370B Trombone** **\$5**



Deg Trombone Slide Extension

DEGTBSE Helps beginning trombone players reach extended slide positions. Easy to install and can be left on the instrument when put into case.

\$16



Bach Trumpet Grime Gutter

627TP Fits Trumpet, Cornet & Flugelhorn
Lightweight, flexible plastic, attaches easily to bottom of the valve casing to absorb oil without inhibiting valve action.

\$6



Taylor Cleaning/Duster Brush

825B Nylon bristles. Good for removing dust or lint around posts, springs and under key rods.

\$3 Each
\$7 Set of 3



Mouthpiece Brushes

1021MB Reed Mouthpiece Brush
Twisted wire handle with tapered nylon brushes.

1022MB Brass Mouthpiece Brush
Twisted wire handle with tapered nylon brushes.

\$2 Each
\$8 Set of 6



Rico Pad Guards

Designed to protect reed instruments.
Leave in the instrument during storage.
Dries & draws the moisture into the swab & away from the instrument interior.

Model	Instrument	Sale
RPG-P	Piccolo	\$9
RPG-F	Flute	\$10
RPG-CL	Clarinet	\$11
RPG-SS	Soprano Sax	\$14
RPG-AS	Alto Sax	\$15
RPG-TS	Tenor Sax	\$17

Instrument Accessory Packages

Packages Include:

Cleaning Care Kit w/instructions, Case Name Tag, Fingering Chart, Music Folder, Wire Music Stand, Method Book Options: **Choose One:**

Accent on Achievement, Band Expressions, Essential 2000 Band, Sound Innovations, Standard of Excellence, Tradition of Excellence

Brass Instruments	Sale
Trumpet / Cornet <i>*Specify Brass or Silver</i>	\$35
French Horn	\$35
Trombone	\$35
Baritone	\$35

Reed Packages includes 5 Rico #2 Reeds

Reed Instruments	Sale
Flute (no reeds)	\$35
Bb Clarinet <i>*Specify Plastic or Wood</i>	\$45
Bass Clarinet	\$45
Alto Sax	\$45
Tenor Sax	\$45

String Method Book Choices:

Essential 2000 Strings, Orchestra Expressions

Strings	Sale
Violin	\$35
Viola	\$35
Cello	\$35

Rico Mouthpiece Swab

Dries & draws the moisture into the swab & away from mouthpiece interior.

MS-C/AS Clarinet/Alto Sax
MS-TS Tenor Sax

\$2.50 Each
\$24 Dozen (Any Mix)



Rico Sax Neck Saver

Dries & draws the moisture into the swab & away from sax neck interior.

RSN Alto/Bar
RTN Tenor **\$8**



Bach Mouthpiece Pouch

Padded nylon pouch holds and protects a single mouthpiece. Zipper closure.

1891 Cornet/Trumpet
1892 Trombone/Baritone **\$10**
1893 Tuba/Sousa

Care/Cleaning Kits

Includes an assortment of supplies (polishing cloths, oils, swabs, etc.)

\$12 Each
\$111 Dozen
Any Mix

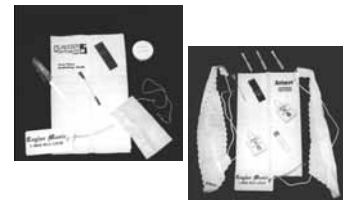

Model	Description
MK-FL	Flute
MK-CC	Clarinet (Plastic Body)
MK-WC	Clarinet (Wood Body)
MK-OB	Oboe
MK-BA	Bassoon
MK-AS	Alto Sax
MK-TS	Tenor Sax
MK-TR	Cornet/Trumpet (Brass Finish)
MK-ST	Cornet/Trumpet (Silver Finish)
MK-TB	Trombone
MK-FH	French Horn
MK-LB	Baritone/Tuba
MK-VI	Violin
MK-VA	Viola
MK-CE	Cello

Absorbent Swabs

Bb Clarinet Swab

CS100 Dri bore, felt type



\$3 Each / \$24 Dozen

Alto/Bass/Contra Clarinet Swab

2947 Dri Bore, high quality, absorbent swab designed for Alto Clarinets, Bass Clarinets and Contra Clarinets.



\$4

Oboe Swab

578 Lightweight absorbent cloth swab



\$5

Bassoon Swab (Set)

BS400 Set of 2; absorbent, worsted material with handles.

\$10 Set



Sax Swab

SS200 Felt cloth with brush.

\$4 Each / \$44 Dozen

Clarinet
Oboe



Wire Handle Swab

Absorbent worsted swab with twisted wire handle.

CSW101 Bb Clarinet **\$3**

OSW300 Oboe (Double End) **\$3**

Hodge Silk Swabs

100% Silk.
Pulls easily through instrument.



Model	Instrument	Sale
FB3	Flute	\$7
OB1	Oboe	\$7
CB1	Clarinet	\$10
AB1	Alto Sax	\$11
TB1	Tenor Sax	\$12

Taylor Soprano Recorders

SR-60E 3 Piece brown, plastic body. English (baroque) fingering. Includes fingering chart, cleaning rod and carrying bag.



**\$6 Each
\$55 Dozen**

Yamaha Recorders

Specially designed for beginning students and are easy to play in every range. They offer the ideal amount of air resistance for effortless control and accurate intonation, provides rich, full sound.



Colors Available:

YRS-24B Blue
YRS-24G Green
YRS-24P Pink
YRS-24T Tan

**\$7 Each
\$70 Dozen**

Bach Trumpet/Cornet Valve Guard

8311T Fits all trumpets and cornets, including instruments with triggers. Tan, leather like material.



\$8

Conn French Horn Valve Guard

551VG French Horn valve guard. Brown soft leather.



\$10

Holton French Horn Valve Guard

L2464 French Horn valve guard. Black soft leather, lace up.



\$10

Osmun French Horn Strap

LSHH Combination holding strap & handguard. Designed to keep your left hand from sliding and take pressure off your little finger. Velcro straps.



\$23

Venus II Twirling Batons

Twirling Batons with dimensional stars on large ball end with hand hammered grips on the shaft. Steel shaft measures 3/8".



Sizes Available: 22", 26", 27", 29"
(Specify when Ordering)

**\$20 Each
\$100 Set of 6**

King David Conducting Baton

KD12B 12" White Fiberglass baton with tapered cork handle.



\$7

Mollard Conducting Batons

'P' Series Batons are our most popular Mollard baton. Famous for the lightweight, precision balance, beauty and responsiveness. Small teardrop style handle.



\$24

Model	Description
P12OW	12" Oak Handle
P12CW	12" Cocobolo Handle
P12PW	12" Purpleheart Handle
P12RW	12" Rosewood Handle
P12WW	12" Walnut Handle
P14OW	14" Oak Handle
P14CW	14" Cocobolo Handle
P14PW	14" Purpleheart Handle
P14RW	14" Rosewood Handle
P14WW	14" Walnut Handle





Yamaha Marching Tuba Shield

YMA-TBP Designed for YBB202M. Provides protection from damaging blows on and off field. Universal fit for most tubas. Heavy gauge plastic and high density foam with lightweight, durable corduroy nylon cover. Nylon straps & plastic clips keep shield in place. List \$124.99

\$70



Sousaphone Pouch

SP10 Cloth pouch with zipper closure, 3 inside pockets to hold sousaphone mouthpiece, tuning bits & mouthpiece.

\$13 Each

\$33 Set of 3



Universal Sousa Protecto Pads

SPP Set/2 pads. Foam padded carriage and shoulder pads. Carriage pad protects the bottom bow from dents & scratches. Shoulder pad adds comfort to the player's shoulder and protects the finish. List \$135

SPP11 White

\$77 Pad Set

SPP21 Black

Sousaphone Neck & Bits

Clear Lacquer finish neck & bits.

Photo	Brand	Neck	Bits Set of 2
A	Buescher (Conn Style) Conn (All Models) Pan American (Conn Style)	\$80	\$45
B	King (Older Models)	\$80	\$45
C	King (New Style)	\$80	\$45
D	Olds / Reynolds	\$80	\$45
E	Signet / Buescher / Bundy	\$85	\$80
F	Holton	\$85	\$80
G	Jupiter	\$75	\$70
H	Yamaha	\$95	\$105
	--- Silver Finish, ADD	\$30	\$25

*Specify brand with order.



FREE SHIPPING
U.S. Contiguous

ON ACCESSORY
ORDERS OVER

\$75

(Exclusions are noted)

Al Cass Oil

133 The famous Al Cass "Fast" is a combination valve, slide, and key lubricant that will not gum or separate under any weather conditions! 2 oz. bottle.

\$6 Each
\$55 Dozen



Roche Thomas Mi-T-Slick

Premium valve/slide oil made with a special filtering process to eliminate impurities.

RT14

2 oz Bottle **\$4 Each**
2 oz Bottle **\$44 Dozen**



16 oz Bottle

RT16

16 oz Bottle **\$10 Each**

Superslick Plus Slide Treatment

SST21 Silicone additive. Use along with slide cream and water for smooth working slide action.

\$3 Each
\$28 Dozen



Superslick Slide Cream

SSC20 Creamy paste applied to trombone slide and spritz with water.

\$3 Each
\$28 Dozen



Superslick Pocket Spray Bottle

SSB22 Pocket size bottle (used by all trombonists to provide lubrication to slides) measures 4.75" tall. It puts out a fine mist of water, providing an even coating for any slide.

\$3 Each
\$22 Dozen



Bach/Conn/Holton/Selmer Lubricants

Use quality lubricants for longer instrument life and better all-around performance. Leakproof plastic containers are conveniently sized. Dropper spouts dispense controlled amounts of lubricant.

\$4 Each
\$36 Dozen (Any Mix)

Bore Oil

4105 Prevents moisture absorption in wood. Tasteless, odorless. 1.5 oz bottle.



Liquid Slide Cream

2922 Mild homogenized oils mean superior close tolerance lubrication. Self-cleaning, long lasting, leaves no build up. 1.5 oz bottle



Tuning Slide & Cork Grease

2942 Clean, neat, and effective. Restores neglected tuning slides and corks, makes for smoother operation and easier assembly of instrument parts. 1.5 oz bottle.



Key Oil

4104 For delicate instrument parts. Highly refined, water-clear. Neat, odorless, stainless, non-gumming. 1.6 oz bottle.



Bach Valve Oil

VO1885SG Highly refined lubricant specially formulated to minimize valve wear. 1.6 oz bottle.



Rotary Valve Oil

3261 For close tolerances of rotary valves. 1.5 oz bottle.



Taylor Music Slide Oil

TMS25 A superb blend of refined oils give your slide the ultimate response needed. Packaged in 1.25 oz. bottles

\$2 Each
\$14 Dozen



Taylor Valve Oil

TMV24 A superb blend of refined oils give your valves the ultimate response needed. Packaged in 1.25 oz. bottles

\$2 Each
\$14 Dozen



Taylor Music Cork Grease

TMC23 Tube style cork grease for easy application on your woodwind instrument.

\$2 Each
\$14 Dozen



Alisyn Valve/Slide/Key Oil

PN2090 High performance synthetic oil for brass instrument valves, slides and woodwind keys.

\$3 Each
\$33 Dozen



Trombotine Slide Lubricant

338 Internationally acclaimed trombone slide lubricant. Made in England. 1.2 oz tube. Ensures slick slide action.

\$6 Each
\$55 Dozen



Leblanc Slid-Eze & Cork Grease

3288 1.5 oz tube. Prevents sticking, corrosion and leakage on brasswind slides. May be used to lubricate woodwind cork tenons. Will not dry out, gum up or harden.

\$2 Each
\$18 Dozen

Blue Juice Valve Oil

BJ2 2 oz Bottle
Provides fast valve action.
Effective on close tolerance valves.
Excellent protection against mold and bacteria growth.



\$5 Each
\$44 Dozen

Yamaha Synthetic Valve Oil

YAC-RVO 38 ml Bottle
Superior oil, regular formula allows the oil to evaporate smoothly. Guaranteeing a longer life and extremely responsive action.



\$8 Each
\$77 Dozen

Roche Thomas MI-T-MIST Disinfectant Spray

RT19 2 oz Pump Spray Bottle

\$4 Each

RT55 8 oz Pump Spray Bottle
Provides a cleaning and refreshing agent that removes residue build up.

\$8 Each
\$22 Set of 3
\$36 Set of 6



Slide-O-Mix Slide Lubricant

337 Slide-O-Mix offers exceptional lubrication for trombone hand slides. Offers a heavy and a light slide lubricant; one for regular slides, one lighter kit for newer, tighter slides. Give trombone a quick, smooth and flawless response.

\$13 Kit
\$33 Set of 3

Slide-O-Mix Rapid Comfort

337RC 30 ml Bottle
Rapid and reliable solution from one bottle for those searching for a slide action without stopping or sticking. Can be used in addition to the Slide-O-Mix set.



\$8
\$77 Dozen

Sterisol Mouthpiece Disinfectant Spray

1885 A Must Have for every band room. Ideal for cleaning & disinfecting mouthpieces, whistles, pitch pipes, etc.

\$5 Each
\$12 Set of 3
\$22 Set of 6



ChopSaver Moisturizer

CHOP All natural moisturizer with lemon scent for your lips. Helps reduce swelling. Promotes healing. Provides moisturizing without waxy build up.

\$4

Hagerty Silver Polish

10120 12 oz. Bottle
Safely cleans, shines and protects your instrument.

\$12



Hagerty Silver Polish Spray

14080 8 oz. Can
Enhanced formula works to maintain silver while guarding against tarnish for months. Contains R22; the worlds longest lasting, patented tarnish preventative agent.

\$12



Yamaha Cleaning Pad Papers

YAC1095P Set of 100
For woodwind instruments. Use to remove moisture, oil, dust, etc. from the pads in order to extend their service life.

\$7 Set



Taylor Case Name Tags

TG5 4.25" x 2.25" Plastic case name tag with Taylor Music logo. Includes paper insert.

\$2 Each
\$15 Dozen

Neotech Neck Straps



Neotech Clarinet/Oboe Strap

NECL Fits clarinets, oboes and English horns. Durable neoprene. Unique slide holds desired length. Offers easy two finger adjustment capabilities. Two connection options; attach leather tab to your thumb rest or use the plastic covered metal hook on eyelet attachment on instrument.

\$10



\$15 Each
\$77 Set of 6

Neotech Alto Sax/Tenor Sax Strap

NEBK Black. Soft, durable neoprene with comfort stretch backing for the most comfortable strap. Swivel hook. Helps reduce neck & shoulder pressure, fatigue and bounce.



Neotech Tuba Harness

THRBK Fully adjustable, conforms to shape of body. Evenly disperses instrument weight. 22" - 27" from top of shoulder to connector hooks where either the cradle or loops attach to main harness. Two connections: cradles lower section of tuba or loop connectors that attach to eyelet on lower section. Also has added upper support strap for added stability.

\$40



Neotech Bari Sax Strap

NEBS Soft, stretchable neoprene neck padding for comfort. Designed longer than most sax straps. To be used by taller players or for instruments that need to hang a little lower (Tenor or Bari Saxes). Black only.

\$15



Neotech Saxophone Harness

NESH Comfortable and functional. Carries the burden of a heavy instrument. Allows player a full range of movement. Strong and durable. Spring loaded swivel clip for security. Extra-long model adjusts from 18" to 22.5". Ideal for bari saxes. Basic concert black.

\$25



Selmer Bass Clarinet Strap

7929 Black neck band with matching nylon cord. Will not twist. Two heavy duty plastic hooks.

\$18



Selmer Alto/Tenor Sax Strap

333BK Black nylon webbed strap Padded 1.5" neck band. Attaches to sax with open vinyl coated metal hook. Adjustable, strong and durable. Fits Alto or Tenor saxophones.

\$5 Each
\$22 Set of 6
\$33 Set of 12



Bassoon Seat Strap

6562 Leather strap with snap hook and a split ring. The split ring attaches through the hole in the boot cap rib, the snap hook hooks to the ring.

\$18



Conn Baritone/Tuba Strap

560 Extra wide, heavy duty black cowhide leather, fully adjustable with metal buckle and two swivel snap hooks.

\$18

Taylor Deluxe Sax Strap

TDSS Nylon 1" wide black strap with padded neck, plastic clamp hook with swivel.

\$7 Each
\$33 Set of 6



FREE SHIPPING
U.S. Contiguous
ON ACCESSORY
ORDERS OVER
\$75

(Exclusions are noted)

Ferree's Band Instrument Repair Kits

Ferree's offers three types of repair kits.
 Economy Kit for minimum repair emergencies.
 Standard Kit for minor repair emergencies.
 Deluxe Kit for spot repairs to "keep 'em playing".



Economy Repair Kit

Q31 The perfect for minimum repair emergencies: the band at an out of town game, parade time or for the music major. List \$346

\$235

Contents Include:

Cork cement, swivel top screwdriver, cork knife, special pad prick, valve cleaning rod, French horn cord, chain nose pliers, spring hook, key oil, pad leveling tool, asst. sheet cork, tapered sax neck corks, pad cement, cork grease. Asst. clarinet pads, sax pads, flute pads. Asst. valve springs, flat springs, water key springs, stainless steel round springs. Sax felts and bumpers, water key corks. Asst. flat spring screws, pivot and thumb rest screws. Asst. valve stem corks and felts.

Deluxe Repair Kit

Q29 This complete kit is designed for salesmen, band directors and stores without repair shops. It contains most items needed for on the spot repairs to "keep 'em playing". The container is a sturdy metal box which may be padlocked. List \$2080

\$1385

Contents:

Tools: Ferree's mouthpiece puller, jeweler's anvil-swivel top screwdriver, mouth blowpipe, valve mirror, pad leveling tools, tweezers, spring hook, hammer, rawhide mallet, bench knife, cork knife, swedging pliers, chain nose pliers, round nose pliers, key bending pliers, heat treated diagonal cutters, spring punching pliers, alcohol lamp, lead block, warding file, parallel round file, testing feeler holder, clamp on vise, pivot screw key reamer, solder scraper, flute gauge.

Supplies: Mouthpiece brushes, flexible trombone brush, valve brush, emery strip, wet & dry paper. Clarinet, sax and flute pads. Sheet cork (1/64", 1/32", 1/16", 3/32"). Tube, waterkey and valve stem corks and felts. Sax key felts, sax bumpers, pad & cork cement. Flat springs, flat spring screws, stainless steel round springs, waterkey spring, valve springs. Valve, slide, bore and key oil. Wood screws. Goldbeater skin, valve cleaning rod, cork cement, soft solder, solder flux, French horn cord, split rivets, clarinet swab, cork grease. Sax & clarinet pivot screws, lyre screws, ligature screws, baritone & sousa bell screws. Brasso, cheesecloth, Silvo, bench oiler, testing corks, scale shellac, wood wedges, binding wire, asbestos millboard.



Standard Repair Kit

Q30 For band directors or salesmen who don't want to get into emergency repairs deeply enough to buy the Q29, this Q30 Standard Kit is the answer to many problems. List \$700

\$455

Contents:

Cork cement, swivel top screwdriver, spring hook, feelers, cork knife, special pad prick, pad leveling tool, Brasso, rawhide mallet, pivot screw key reamer, stick shellac, sheet cork (1/64", 1/32", 1/16", 3/32"). Valve, key, slide and bore oil, cork grease. French horn cord, alcohol lamp. Round nose pliers, key bending pliers, valve cleaning rod, valve mirror, emery strip. Asst. clarinet pads, sax pads, flute pads. Asst. valve springs, flat springs, water key springs, stainless steel round springs. Asst. water key corks, tapered neck corks, valve stem corks. Asst. valve stem felts, sax key felts, felt bumpers. Asst. flat spring screws, pivot & rest screws, lyre screws, ligature screws, baritone & sousa bell screws.



(Exclusions are noted)



Valentino Repair Kits

Model	Description	List	Price
VDRK	Deluxe Kit Contains 600 repair items for Brass & Woodwinds	\$629.50	\$399
TTRK	Teacher Travel Kit Contains 400 repair items for Brass & Woodwinds	\$427.50	\$288
VSRK	Standard Kit Contains 250 repair items for Brass & Woodwinds	\$277.50	\$177



Taylor Marching Flip Folios

1005-5 Flip Folio includes (5) individual clear vinyl windows. Each window holds 2 sheets of music. Backing is heavy reinforced vinyl. Includes metal rings.

\$7 Each
\$70 Dozen



Replacement Flip Folio Windows

1005-5W, Dozen

\$7

Replacement Flip Folio Rings

1005-5R, Dozen

\$7

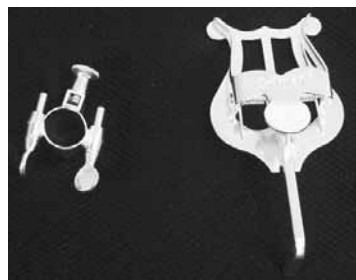

Bach Trumpet Lyres

1815S Silver plated top-quality Bach trumpet clamp-on lyre.

\$17



Deg Marching Flip Folios

HC200 Includes (5) individual clear windows with black paper insert. Fits all lyres. Plastic backing with plastic rings.

\$4 Each
\$40 Dozen

Replacement Flip Folio Windows

HC200-W, Dozen

\$5



Replacement Flip Folio Rings

HC200-R, Dozen

\$5



Deg Marching Lyres

Model	Description
HC225	Flutist Friend Mounts on players forearm, complete with plastic backing, 5 music windows & plastic rings.
HC240	Drummer's Delight Snare Mounts directly on snare drum, remove tension screw, put screw through hole in base then return screw to drum. Complete with 5 music windows & plastic rings.
HC245	Marching Bass Drum Mounts directly on top of bass through tension rod, complete with 5 music windows & plastic rings.
HC260	Marching Trumpet Clamps directly on trumpet bell, plastic coated clips, complete with 5 music windows & plastic rings.
HC250	Marching Trombone Lyre Clips on side of bell closest to slide, plastic coated clamps, complete with 5 music windows & plastic rings

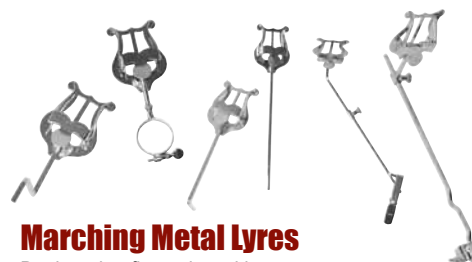

Marching Metal Lyres

Designed to fit any brand instrument.

Model	Description	Price
500LG	Low Brass (Straight) (Short 5 3/8" Stem)	\$5
500XLG	Low Brass (Straight) (Long 8.5" Stem)	\$5
501G	Trumpet (Bent Stem)	\$5
506N	Clarinet (with Ring)	\$5
517G	Saxophone	\$5
514G	Trombone (2 Pc Reg Bore)	\$5

\$55 Dozen - Any Mix

Model	Description	Price
502N	Trumpet (Clamp-on)	\$9
513N	Flute (Clamp-on)	\$10
515G	Trombone (2 Pc Lg Bore)	\$10

\$66 Dozen - Any Mix



\$10 Each

\$99 Dozen
Any Mix

Humes & Berg Stonelined Mutes

Play perfectly in tune and are easy blowing.
For the perfect professional sound all the time.

Description	Model	List	Sale
Trumpet Straight	101TP	\$26.00	\$16
Trumpet Cup	102	\$43.50	\$26
Trumpet Velvet-Tone 4"	108	\$34.50	\$21
Trumpet Plunger (all rubber)	113	\$44.50	\$27
Trumpet Practice	132TP	\$43.50	\$26
Trombone Straight	151	\$34.00	\$20
Trombone Cup	152	\$52.50	\$31
Trombone Velvet-Tone 8.5"	160B	\$52.50	\$31
Trombone Plunger (all rubber)	164	\$51.50	\$31
Trombone Practice	167	\$47.50	\$28
Bass Trombone Straight	170BT	\$45.50	\$27
Bass Trombone Cup	171	\$59.50	\$36
French Horn (Transposing)	119FH	\$74.50	\$44
French Horn (Non-Transposing)	121FH	\$48.00	\$28
French Horn Practice	250	\$49.50	\$29



Tom Crown All Aluminum Mutes

Bell shaped contour that makes them a perfect acoustical match. Produces a unique, lovely sound and still allow the power necessary in large ensembles.

Description	Model	List	Sale
Trumpet Straight 30TA	TC1	\$62	\$39
Trumpet Cup 30TCUP	TC15	\$66	\$42
Trumpet Wah-Wah 30TWW	TC5	\$75	\$47
Trombone Straight 30TT	TC7	\$79	\$49
Trombone Bass Straight 30BT	TC9	\$84	\$53
Trombone Cup 30TTCUP	TC16	\$87	\$55
French Horn Transposing 30FH <i>Lacquered brass, leather loop</i>	TC10	\$103	\$65



(Exclusions are noted)

Denis Wick Aluminum Mutes

Description	Model	List	Sale
Trumpet Straight	DW5504	\$61.99	\$38
Trumpet Cup Adjustable	DW5531	\$93.99	\$59
Trombone Straight	DW5505	\$87.99	\$55
Trombone Cup Adjustable	DW5529	\$124.99	\$77



*Other models available. Call for Options & Price.

Yamaha Silent Brass System Mutes

New lightweight design of pick up mute and revolutionary brass resonance modeling technology of the Personal Studio combine to deliver a more realistic experience.

Personal Studio System Includes:

Pickup Mute, Digital Processor, Stereo Earphones & Cables

Instrument	Model	List	Sale
Trumpet	SB7XC	\$229.99	\$159
Flugelhorn	SB6XC	\$239.99	\$169
Tenor Trombone <i>fits bell size up to 8.5"</i>	SB5XC	\$249.99	\$169
French Horn	SB3XC	\$259.99	\$179



Standard System Includes:

Pickup Mute, Personal Studio, Stereo Earphones & Cables

Instrument	Model	List	Sale
Euphonium *	SB29C	\$262.99	\$219
Tuba *	SB19C	\$524.99	\$419



*Factory Order



Harmon Metal Mutes

Create a classic sound for all levels of brass players.
Aluminum with polished finish and high quality cork.

Description	Model	List	Sale
Trumpet Straight Most popular straight mute! 4 cork seating can be shaved for custom fit.	G1	\$40	\$28
Trumpet Wah Wah Wow Wow mute allows player to create a variety of sounds.	B	\$58	\$38
Trumpet Triple Play Combination straight mute, cup mute and plunger mute all in one.	J1	\$65	\$42
Trombone Straight Most popular straight mute! 4 cork seating can be shaved for custom fit.	G3	\$58	\$38
Trombone Wah Wah Wow Wow mutes allows player to create a variety of sounds.	E	\$93	\$60
Trombone Triple Play Combination straight mute, cup mute and plunger mute all in one.	J3	\$79	\$52

Band Method Books



Accent on Achievement
Level 1
 Most Instruments **\$8.99**
 Percussion **\$11.99**
 Conductor **\$49.95**



Alfred's Drum Method
 Level 1 & Level 2
\$9.99



Band Expressions
Level 1
 Most Instruments **\$8.95**
 Percussion **\$29.95**



Essential Elements 2000
Level 1
 Most Instruments **\$8.99**
 Oboe & French Horn **\$9.99**
 Percussion **\$14.99**
 Conductor **\$39.99**

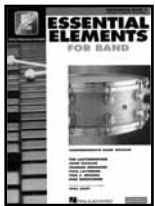

Essential Elements 2000
Level 2
 Most Instruments **\$7.99**
 Percussion **\$14.99**
 Conductor **\$34.99**



Essential Technique 2000
Level 3
 All Instruments **\$7.99**
 Percussion **\$14.99**
 Conductor **\$34.99**



Fundamental Studies for Mallets
 Level 1 **\$16.95**



Haskell W. Harr Drum Method
 Level 1 w/CD **\$14.99**
 Level 2 no CD **\$10.95**



Measures of Success
Level 1 & Level 2
 Most Instruments **\$8.95**
 Oboe & French Horn **\$9.95**
 Level 1
 Percussion **\$16.95**
 Conductor **\$39.95**

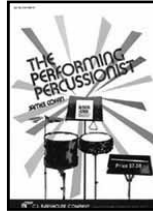

Performing Percussionist
 Level 1 **\$12.95**
 Level 2 **\$9.95**



Rubank Intermediate
Level 2
 All Instruments **\$5.95**



Rubank Advanced
Level 1
 All Instruments **\$6.95**



Sound Innovations
Level 1 & Level 2
 Most Instruments **\$8.99**
 Percussion **\$12.99**
 Conductor Lvl 1 **\$49.99**
 Conductor Lvl 2 **\$54.99**



Standard of Excellence Enhanced Series
Level 1 & Level 2
 Most Instruments **\$9.95**
 French Horn **\$10.45**
 Percussion **\$10.45**
 Conductor **\$49.95**



Tradition of Excellence
Level 1
 Most Instruments **\$10.95**
 French Horn **\$11.50**
 Percussion **\$13.50**

Orchestra Method Books



Essential Strings 2000

Level 1
Violin, Viola,
Cello, Bass **\$8.99**

Conductor **\$34.99**

Level 2
Violin, Viola,
Cello, Bass **\$7.99**



Orchestra Expressions Strings

Level 1
Violin, Viola
Cello, Bass

\$8.95

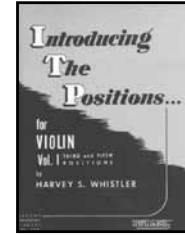

Rubank Whistler Strings "Introducing the Positions"

Level 1
Violin, Viola, Cello

\$7.95



Measures of Success Orchestra

Level 1
Violin, Viola
Cello, Bass

\$8.50



Simandl New Method String Bass

Level 1 **\$24.95**



Suzuki Strings

Level 1 w/CD
Violin **\$19.99**

Level 1 & 2 No CD
Violin **\$7.99**
Viola, Cello, Bass **\$6.99**

CD Sets

Violin Lvl 1 **\$15.95**

Viola Lvl 1 & 2 **\$15.95**

Cello Lvl 1 & 2 **\$15.95**

Orchestra Folders

SMALL SIZE:

9.75" wide by 12.25" high
4" inside pockets
Perfect for book bags
Color: Burnt Orange



- SOF12 Set of 12 **\$23**
- SOF50 Set of 50 **\$73**
- SOF100 Set of 100 **\$133**
- SOF225 Box (225) **\$233**

LARGE SIZE:

11.75" wide by 14" high
3.75" inside pockets
Color: Burnt Orange



- GOF12 Set of 12 **\$23**
- GOF50 Set of 50 **\$73**
- GOF100 Set of 100 **\$133**
- GOF250 Box (250) **\$253**

Band Folders

Available in 2 sizes:

SMALL SIZE:

9.75" wide by 12.25" high
4" inside pockets
Perfect for book bags
Color: White



- SCF12 Set of 12 **\$15**
- SCF50 Set of 50 **\$55**
- SCF100 Set of 100 **\$100**
- SCF225 Box (225) **\$195**

LARGE SIZE:

11.75" wide by 14" high
3.75" inside pockets
Color: Green



- LCF12 Set of 12 **\$15**
- LCF50 Set of 50 **\$55**
- LCF100 Set of 100 **\$100**
- LCF250 Box (250) **\$215**

Pep Band Folders

Marching Music Paper Folios
5.5" high x 7.5" wide
Color: Blue

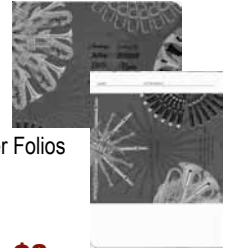

- PBF12 Set of 12 **\$8**
- PBF50 Set of 50 **\$30**
- PBF100 Set of 100 **\$50**



(Exclusions are noted)



MegaVox Pro PA Sound System

Great for School Bands, Drum Corps,
Coaches & Auctioneers.
Designed for audiences up to 1000 people
15 lbs - Lightweight
126 dB SPL from 22 watt amplifier
1/4" line input, 1/4" line output, 1/4" speaker output
Optional Single or Dual UHF wireless speakers
Rechargeable Battery (10 Hrs per charge)
6 Year Warranty, 110/220 Power Supply
Each wireless channel has 16 frequencies built in

Description	List	Sale
MegaVox Pro Basic Package Includes: MEGA8000U1 Unit w/Bluetooth & 1 Wireless receiver, SS550 Stand, WB8000 Body-Pack, HBM-TA4F Headset Mic	\$1556	\$1264
MegaVox Pro Dual Basic Package Includes: MEGA8000U2 Unit w/Bluetooth & 2 Wireless receivers, SS550 Stand, WB8000 Body-Pack, HBM-TA4F Headset Mic (2 Ea)	\$2156	\$1744
MegaVox Pro Deluxe Package Includes: MEGA8001U1 Unit w/Bluetooth & 1 Wireless receiver, MEGA8001 Companion speaker, SC50 Connection cable, 2) SS550 Stands, WB8000 Body-Pack, HBM-TA4F Headset Mic	\$2001	\$1620
MegaVox Pro Dual Deluxe Package Includes: MEGA8001U2 Unit w/Wireless receiver, MEGA8001 Companion speaker, SC50 Connection cable, 2) SS550 Stands, WB8000 Body-Pack & HBM-TA4F Headset Mic (2 Ea)	\$2601	\$2100

Options

Description	Model	Sale
Hard Case with Foam	HCARMOR24MV	\$340
Soft Rolling Case (for Unit & Stand)	SOFT-MEGA	\$240
Nylon Case	NL-MEGA	\$40
Speaker Cable 50'	SC50	\$36
Charger	RC8000	\$27
Collar Mic	CM60	\$80
Lapel/Lavalier Mic	LM60	\$80
Wireless Backpack Transmitter	WB8000	\$240

Lectrosonics Long Ranger Replacement Headsets



HM162MC Over Ear Mic Headset

Lightweight, noise cancelling design. To be used with high output PA systems. Adjustable lightweight headband provides comfortable fit. Over the ear design allows a cap or hat to be worn without interfering with microphone.

\$144



M140MC Lavalier Mic

Characterized by a bright overall sound due to the nature of the directional pick up pattern. Not recommended for use in windy conditions. For best results place mic in center of chest.

\$105



(Exclusions are noted)

ACTION!





Dr. Beat Timekeeper Metronome

DB60 Provides a menu of rhythmic patterns, a note mixing feature to create rhythms that match the feel and style of your music. Other features: 17 beats per measure, loop play for calling up memory settings, memory function, tap tempo, timer, stopwatch and backlit display. List \$119.50

\$85



**Limited Quantities Available*

Qwik Time QT3 Metronome

Quartz Metronome. Red led beat light (optional on/off). Louder speaker, distinctive click sound cuts through music (optional on/off). A440 tuning tone. Low battery indicator. Earphone jack. Speed settings over 200. Includes 9V Battery.

\$16



Dr. Beat Rhythm Coach Metronome

DB90 Loaded with features—onboard mic, reference tone function for tuning and instrument input, MIDI input. Other features: trigger input to access unique rhythm exercises, PCM sound with drum machine style patterns, 50 memories, and human-voice count. List \$233.50

\$166

McAdams Instruments Model-30 Metronome

A powerful, portable metronome for classroom use. Units weigh 7 lbs.

Features:

- Infrared Remote control
- 5 Octave Tone generator
- Adjustable pitch reference
- Improved measure handling
- Set tempo by controls or tapping
- Tuning for band & strings
- Saves frequently used set ups
- Spectrum analyzer
- Visual tuner
- Stop watch



\$959



Boss AC Adaptor

PSA120 Recommended power supply for Tuners & Metronomes.

\$25

***Factory Order - Allow 2-3 weeks*



(Exclusions are noted)

Shure Dynamic Microphones

SM57 Instrument Mic exceptional for instrument pickup and vocals. Ideal for live sound reinforcement and recording.

\$99

SM58S Vocal Mic designed for live performances, sound reinforcement and studio recording. Rugged construction with On/Off Switch.

\$104

***Cable not included.*



Shure Microphone Cables

Hi-flex Cable with chrome XLR connectors; low impedance.

- C25J** 25' Cable **\$18**
- C50J** 50' Cable **\$23**

Master Key Pitchpipe

The ultimate instrument for obtaining exact musical pitch. 13 hand tuned, special bronze reeds with patented tone chambers, precision tuned and double checked to A440, the full chromatic scale. Proper note selection is assured as the scale is arranged in sequence and clearly marked by embossed notations on both top and bottom covers.



Your Choice:

MK1 (F to F)

Popular for timpani tuning

\$19

MK2 (C to C)



Peterson TP-3 Clip-on Tuning Pick-up Mic

Clips on any instrument & picks up the vibrations of the instrument. It is totally isolated from any other sound in the room. Will work with brass, reed and stringed instruments.

\$11



Korg CM200L-BK Contact Mic

Designed for better fit and durability. Easily attaches to bell of brass instruments. Piezo element captures vibrations for easy tuning.

\$14

Pearl TB001 Tune-Bot Drum Tuner

Fast, accurate & effective electronic drum tuner. Save time on multiple drum tuning. Measures true fundamental & lug to lug pitch. Interval tuning of Toms. Displays pitch in hertz and musical notes. List \$149.95

\$99



Korg CA1 Chromatic Tuner

LCD needle type meter. Pitch detection covers C1-C8. Calibration function. Auto Power Off function. Approx. 100 hours of continuous use. Memory backup function. 2 AAA Batteries included.

\$22



Korg TM50 Combo Metronome Tuner

Combination Metronome & Tuner can be used simultaneously or independently. Black color
Pitch & Rhythm training
2 Level backlight enhances LCD display
Needle style LCD for excellent response & greater tuning accuracy
C1 to C8 Wide detection range
30-252 Beats per minute tempo range
15 Rhythm variations
Easy tempo and tap settings
Entry level mode provides Sound Back function (Allow speaker to generate reference tones.)
Memory backup & Auto power off
2 AAA Batteries included

\$30



Korg OT120 Tuner

Orchestral Tuner, reference pitch
Needle display
Auto/Manual tuning mode
5 Octaves (2 volume levels)
A0-C8 Wide measurement range
Calibration range: A4=438 to 499 Hz, 1 Hz steps
Built in microphone
Input jack, output jack, sound, DC in
Includes 2 AA batteries

\$84



FREE SHIPPING
U.S. Continuous
ON ACCESSORY
ORDERS OVER
\$75

(Exclusions are noted)

KORG

Orchestra String Accessories



Ebony String Mutes

Easy-on, easy-off mute. Fine quality ebony in the traditional 3-prong design.

- GL3812 Ebony Violin **\$5**
- GL3814 Ebony Viola **\$6**
- GL3816 Ebony Cello **\$10**



Tourte String Mutes

Conforms to shape and curvature of bridge for better contact, greater muting power, and balanced sound. Installs in seconds and is easy to change.

- GL3842 Violin-Viola Tourte **\$3**
- GL3846 Cello Tourte **\$4**



Wire Sliding String Mutes

- GL3800 Violin Wire Sliding **\$6**
- GL3801 Viola Wire Sliding **\$8**
- GL3802 Cello Wire Sliding **\$10**



Violin/Viola Rosin

UVR Single Amber Cake Rosin mounted in wood holder.

- \$2 Each**
- \$4 Set of 3**

Pops Bass Rosin

POPS Popular with students and professionals. Extremely soft. Provides exceptional grip. Comes in plastic container with snap-top lid.



\$9



Sherman Cello/Bass Rosin

Popular and economical. 2" Dark cake rosin in wood holder.

- 9705 Cello **\$5**
- 9615 Bass **\$5**



D'Addario String Tuners

Built-in piezo transducer picks up vibrations rather than sound. Tri-color reversible backlit LCD screen. Easy to tune in dark areas. Wide calibration range (410HZ to 480HZ). Visual metronome.

PW-CT-14 NS Micro Violin-Viola Tuner

Non-marring, lever-lock clamp holds securely to instrument. **\$24**

PW-CT-13 NS Micro Cello-Bass Tuner

Dual swivel clip-on mount provides quick application to bridge. **\$22**

Orchestra Polishing Cloth

GL3980 Lint free cloth good for wiping down all string instruments.

\$4



Dunlop Orchestral Polish Cleaner

65 2 oz Spray Bottle. Gently removes fingerprints & grime from your string instrument.

\$7



Cello/Bass End Pin Holder

4080 Reinforced metal cup with dense rubber base, textured for durability and secure grip.

\$7



Xeros Cello Anchor Strap

XCA Heavy duty hard rubber cup prevents endpin dulling. 2" wide woven nylon strap. Adjustable D-Ring slips under the chair leg.

\$14



String Instrument Humidifiers

Maintains humidity levels to prevent cracking.

- 5460 Violin/Viola **\$7**
- 5860 Cello **\$10**
- 5960 Bass **\$12**



FREE SHIPPING
U.S. Contiguous
ON ACCESSORY
ORDERS OVER
\$75

(Exclusions are noted)



D'Addario Prelude Violin/Viola Cello Strings

Solid steel core design. Unaffected by temperature and humidity changes. Excellent bow response; warm sound.

Violin - 1/2, 3/4, 4/4

(specify size needed)

J810 Set	\$20
J811 E String	\$4
J812 A String	\$6
J813 D String	\$7
J814 G String	\$8

Viola - 13", 14", Full (15"-16")

(specify size needed)

J910 Set	\$32
J911 A String	\$8
J912 D String	\$9
J913 G String	\$10
J914 C String	\$11

Cello - 1/2, 3/4, 4/4

(specify size needed)

J1010 Set	\$65
J1011 A String	\$16
J1012 D String	\$17
J1013 G String	\$18
J1014 C String	\$21



Thomastik Dominant Strings

These strings have a highly flexible, multi-strand nylon core and cater for artists who feel uncomfortable with steel strings. The resounding success of our Dominant string owes a lot to its similarity in tone and response to gut strings, without gut's attendant drawbacks.

Violin (4/4 only)

GL17004 Set	\$55
GL17014 E String	\$8
GL17024 A String	\$13
GL17034 D String	\$18
GL17044 G String	\$20

Viola (4/4)

GL17104 Set	\$88
-------------	-------------

Glasser Fiberglass Violin/Viola/Cello Bows

Popular Student Model
Genuine Horsehair
1/2 Lined Ebonite Frog
(specify size needed)

Violin - 1/2, 3/4, 4/4

GL2201H	\$38
---------	-------------

Viola - Jr. 13"-14", Full 15" & Up

GL2301H	\$44
---------	-------------

Cello - 1/2, 3/4, 4/4

GL2401H	\$55
---------	-------------



Everest Shoulder Rests

Collapsible and adjustable. Safe design that contains no pinching hazards. Fits in case for easy storage.

Model	Description	Price
EC-4	1/2 to 4/4 Violin	\$21
EZ-VA	15" to 16.5" Viola	\$22



Kun Collapsible Shoulder Rests

Well designed contoured bar covered on one side with comfortable, soft foam sponge. Secures to instrument with rubber feet. Collapsible model features legs that fold down for easy storage in case.

Model	Description	Price
KRC34	1/2 to 3/4 Violin	\$32
KRC	4/4 Violin	\$34
KRV44	Viola	\$36



(Exclusions are noted)

Reconditioned Bows	
Violin	\$25
Viola	\$30
Cello	\$35
Call for Available Sizes	



Resonans Violin/Viola Shoulder Pads

Resonans shoulder rests have a cushioned pad area, covered with velvet to provide a comfortable, secure contact surface. The adjustable feet are covered with surgical tubing to protect the instrument's finish.

Violin (Medium Height)

GL36922M 1/2 Size	
GL36923M 3/4 Size	
GL3692M 4/4 Size	\$12

Viola (Medium Height)

GL3694M All Sizes	\$14
-------------------	-------------



*In Stock



Factory Order
Allow 2-3 Weeks



Coming June 2015

Jiggs pBone Plastic Trombone

Jiggs pBone is a plastic Tenor Trombone endorsed by Jiggs Whigham. Key of Bb, .509" bore, 8" bell. Plastic construction, this lightweight instrument sounds remarkably like typical brass trombones. Fiberglass slide with brass slide stockings on the inner handslide to keep the slide moving freely. The handslide with feel smoother the more you play the instrument, and you can even play the instrument without the need for slide lubrication. The Jiggs pBone includes a plastic mouthpiece and canvas carrying bag.

Color Options:

- PBONE1BLK Black
- PBONE1B Blue
- PBONE1G Green
- PBONE1O Orange
- PBONE1PNK Pink
- PBONE1P Purple
- PBONE1R Red
- PBONE1W White
- PBONE1Y Yellow

\$179

Jiggs pBone Plastic Mini Eb Alto Trombone

Jiggs pBone mini is designed to allow hands of various shapes and sizes to find a comfortable, effective grip. Especially true for the small hands of younger children who can choose from a variety of left hand positions including a "pistol grip" for good lower arm posture. The light weight means supporting the instrument is not a problem for even the youngest of players. Carefully shaped components encourage good posture and the correct positioning of the thumb while discouraging the use of the right hand to support the weight of the instrument. **Features:** 7" Bell, Weighs 1.8 lbs. Lockable slide. **Pitched in Eb.** Waterkey. Plastic material. Small shank. Includes bag.

Color Options:

- PBONE2B Blue
- PBONE2R Red

\$149

Jiggs pTrumpet Plastic Trumpet

Jiggs pBone Trumpet. pTrumpet is the world's first ever fully plastic trumpet – a fully functioning Bb trumpet, designed in the UK for musicians by musicians. A fully plastic valve system which was designed and developed to create unrivalled lightness, durability and sound quality. Patented lead pipe technology ensures a vibrant and focused sound. It is tough, taking knocks and bumps in its stride thanks to its precision plastic engineering. Includes smart gig bag along with a 3C and 5C mouthpiece

Color Options:

- PTRUMPET1B Blue
- PTRUMPET1R Red

\$179



Yamaha Wire Music Stand

MS1000 Wire folding music stand. Black satin finish. Fixed angle desk. Adjustable height. Folds to compact size. Rubber leg bumpers. Music clip attachments. Includes carrying bag.

\$10 Each
\$99 Dozen



Mighty Bright LED Sight Reader Stand Lights

MBCL-BK XtraFlex2, 2 Bright white LED bulbs. Flexible gooseneck, clips on anywhere as well as free standing base. Includes 3-AAA batteries.

\$10 Each
\$111 Dozen



Manhasset Stand Lights

MH1000 Features include glare-free full-width, audience shielded illumination, ample clearance of even the taller scores of music, dual clips for assured attachment yet easily installed and removed. Complete with 40 watt bulb, 8-foot cord and switch. Baked on durable black enamel finish. Rigorously inspected & tested, this lamp is designed for years of trouble free service, ETL and CSA approved.

\$26 Each
\$140 Set of 6

MANHASSET®

Manhasset Symphony Music Stands

M48 The Symphony Stand desk measures 20" wide, 12.5" high. Height varies from 26" to 48" (lip to floor). Maximum overall height of 60.5". Black Satin finish. Constructed of lightweight aluminum. Features Manhasset clutch which eliminates the need for clamps of any type. List \$83 Each (\$996 Dozen)

\$45 Each
\$399 Dozen

3 or More Dozen
\$377 per Doz



Manhasset Director Music Stand

M49 Conductor Stand desk measures 20" wide, 12.5" high. Double desk construction for extra sheet/book storage. Height varies from 26" to 48" (lip to floor). Maximum overall height of 60.5". Black Satin finish. Constructed of lightweight aluminum and features the Manhasset clutch which eliminates the need for clamps of any type. List \$111

\$59

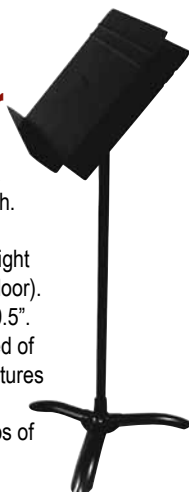

Manhasset Regal Music Stand

M54 Similar construction as the M48 Stand with extra wide desk and double shaft for added support and stability. Desk size measures: 32" wide, 15.25" high, 1.5" deep. The desk extension is 26" x 48". List \$189

\$122



Manhasset Stand Repair Kit

M70 Includes base cup washer, 1.25" cap & screw. After 20 or more years of service, the base adapter and shaft fastener may become loose. The repair kit will replace potentially worn parts on music stands manufactured between the years 1935 and 1969. Prevents wobbling & makes the stand as solid as it was when it was new. These components have been standard on all music stands made since 1970.

\$6

FREE SHIPPING
U.S. Contiguous
ON ACCESSORY ORDERS OVER
\$75

(Exclusions are noted)



Factory Order
Allow 2-3 Weeks

Manhasset Rack 'N Roll Short Stand Cart

1920 Manhasset Stand Cart holds up to 13 music stands. Rugged, steel construction. Overall length of less than 5 ft which takes up less storage space. Includes casters for transporting. List \$518

\$290

Manhasset Rack 'N Roll Regular Stand Cart

1910 Manhasset Stand Cart holds up to 25 concert music stands. Rugged, steel construction. 43" high, 22" wide, 92" long. Heavy duty casters for easy transporting. List \$738

\$375



Factory Order
Allow 2-3 Weeks

Sherrard Roll-Away Storage Racks

Custom made from finest materials available and tailored to fit school needs. A strong, practical, trouble-free rack that will last indefinitely. Made of seasoned oak, finished in natural wood with clear lacquer, mounted on 3" solid rubber casters and padded with green plush.

Rack Description	Weight	Sale
Violin/Viola Rack VI-VO-16 holds 16	85 lbs	\$560
Cello Rack CE-234 holds 2, 3 or 4 <i>Specify when ordering</i> CE-6 holds 6	30-45 lbs 55 lbs	\$450 \$490
Double String Bass DB-23 holds 2 or 3 <i>Specify when ordering</i> DB-4 holds 4	50 lbs 60 lbs	\$450 \$490
Sousaphone * SU-2 holds 2 SU-3 holds 3 SU-4 holds 4	55 lbs 65 lbs 75 lbs	\$450 \$480 \$515
Recording Bass/Tuba * <i>Specify Top or Front Action Valves when ordering</i> RB-TU-2 holds 2 RB-TU-3 holds 3 RB-TU-4 holds 4	60 lbs 75 lbs 95 lbs	\$445 \$495 \$560

* UPS Charges of \$90-\$150 per standard rack
EXTRA fee of \$60-\$80 on oversized racks



Recording Bass/Tuba Rack

**Sherrard Roll-Away
Storage Racks are
Excluded from
FREE Shipping Offer**

K&M Instrument Stands

Instrument	Description	List	Sale
Bassoon	KM1501 Sturdy nickel plated stand with adjustable height. Middle U-clamp holds instrument secure. Tripod base with cup for holding boot joint.	\$159.99	\$109
Bass Clarinet	KM15060 Black adjustable stand w/universal support bracket with tilt & width adjustments. Newly designed V-shaped base for endpin.	\$219.99	\$139
Trombone	KM1499 Sturdy 2 piece stand with wide tripod base. Adjustable plastic peg. Easy height adjustment.	\$89.99	\$69
Baritone	KM14941 Fully adjustable support arms for height and width. Fits all baritones & tenor horns. Nonmarring material covers arms to protect horn.	\$164.99	\$129
Tuba	KM14940 Fully adjustable support arms for height and width. Nonmarring material covers arms to protect horn.	\$164.99	\$129



KM1501

KM15060

KM1499

KM14941

KM14940



KM15232

KM15222

KM1521

KM18020

KM15213

K&M Compact Instrument Stands

Instrument	Description	Sale
Flute	KM152/32 Compact & light 4 leg base. Legs fold for storage inside peg.	\$25
Clarinet	KM152/22 Black 4 leg base. Detaches & screws into peg for easy storage inside bell.	\$25
Oboe	KM180/20 Black 4 leg base. Retracts into plastic peg for storage in case.	\$35
Trumpet	KM1521 Black 3 leg base. Legs fold inside trumpet peg and stores inside bell.	\$25
Trumpet	KM15213 Black 5 leg base. Legs fold inside trumpet peg and stores inside bell.	\$32

Taylor Instrument Stands

Instrument	Description	Sale
Flute/Clarinet	DPS-FL40Y Sturdy construction, heavy black base with screw on peg for holding flute or clarinet.	\$18
Alto/Tenor Sax	DPS-AS32Y Lightweight tubular construction, black finish, two pegs for holding flute & clarinet, folding tri-pod legs, easy set up.	\$34
Bari Sax	DPS-BS50Y Lightweight tubular construction, black finish, folding tri-pod legs, non-slip rubber feet, holds standard or low A models.	\$44
Trumpet	DPS-TR11Y Tri-Pod Legs, Black Metal, Non-Slip Rubber Feet, Adjustable.	\$24
Trombone	DPS-SL21Y Tri-Pod Legs, Black Metal, Non-Slip Rubber Feet, Adjustable.	\$34



Deg Dynasty Tuba Rest Stand MC100

Tuba Rest fits any size tuba & adjusts to any height chair. Eliminates holding tuba on lap. Adjustable height mechanism. 3 leg adjustable base. Special foam pad prevents slipping.

\$79

Carrying Pouch MC100P Tuba Rest Carrying Pouch

\$24

Tuba Stand & Pouch SET \$93

FREE SHIPPING
U.S. Contiguous
ON ACCESSORY
ORDERS OVER
\$75

(Exclusions are noted)

HERCULES
STANDS

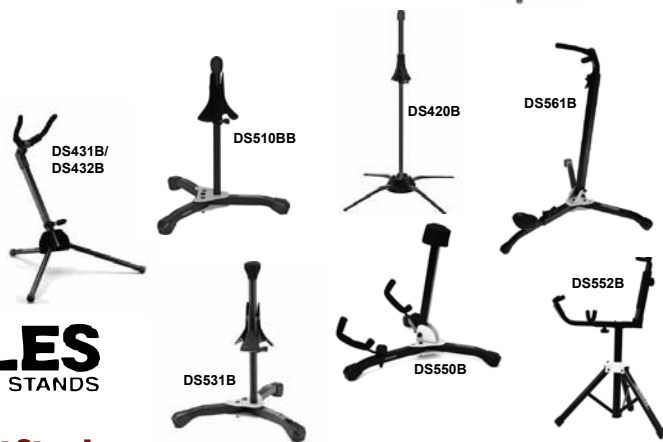

Hercules Instrument Stands

Instrument	Description	List	Sale
Bass Clarinet/ Bassoon	DS561B Multi-functional yoke & base reset for easier instrument access. Lever height adjuster positions yoke to accommodate different bass clarinets and bassoon placements.	\$111.99	\$78.99
Alto Sax	DS431B TravLite portable stand. Solid stand can securely hold your instrument & take no extra space inside case. Velvet bag included for storing inside bell.	\$67.99	\$47.99
Tenor Sax	DS432B TravLite portable stand. Solid stand. Securely holds your instrument & take no extra space inside case. Velvet bag included for storing inside bell.	\$69.99	\$48.99
Soprano Sax/ Flugelhorn	DS531B Adjustable peg and swivel legs. Peg detaches for easy storage.	\$62.99	\$43.99
Trumpet	DS510BB Velvet peg and solid swivel legs. Peg detaches for easy storage.	\$48.99	\$34.99
Trombone	DS420B TravLite portable stand. Telescopic tube with extra height extension allows for easy access during use & compact packing for storage. Velvet bag included for storing inside bell.	\$84.99	\$58.99
French Horn	DS550B Yoke & backrest coated with SFF rubber. Provides safe resting place. 3 locking pins on leg housing. Allows for fast & secure set up and tear down. All in one design.	\$55.99	\$39.99
Low Brass	DS552B (Baritone/Euphonium/Tuba) Extended supports to accommodate various sized instruments. Locking pin & lever for quick setup. All in one design.	\$126.99	\$88.99

Wemsco Hanger Style Instrument Stands

Designed by experts in the field of music. Provide an easy solution to storage. Easily Installed. No special tools required. Two heavy duty screws are used to attach hanger to any wall surface. Upper bracket adjusts to fit each instrument exactly without the use of tools.

397E Euphonium/Baritone \$145

397S Sousaphone \$145

397T 3/4 Tuba \$145

397RB Recording Bass \$160

(Please allow 2-3 Weeks for delivery.)



Hercules iPad-TabGrab Holder

HA300 Mount iPad or tablet to any stand for easy use. 360 Degree ball joint design for tilting positions. Detachable table support included for desktop use. Fits tablets from 8.9" to 10.1". List \$59.99

\$38

Remo Drumheads

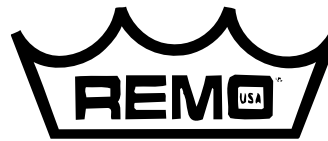

Remo Falam's K Series Marching

Item	Size	Description	List	Sale
KL-0213-SA	13"	Snare Side, Bottom	\$75.60	\$37
KS-0213-00	13"	Smooth White	\$77.50	\$38
KS-0213-C2	13"	Smooth White w/Dot	\$82.00	\$41
KS-0214-00	14"	Smooth White	\$80.40	\$40
KS-0214-C2	14"	Smooth White w/Dot	\$83.70	\$42
KL-0214-SA	14"	Snare Side, Bottom	\$77.50	\$38



Falams: Based on the original Falam (Fabric Laminate) design. Produces excellent stick response with bright, crisp tone. Clear Dot design for extra reinforcement & tone control. The Snare Side head is Remos' strongest. Features Kevlar weave laminated with smooth white film. 7.5-mil construction can withstand extreme tension without choking the drum. Ideal for a crisp, dry, sharp attack.

Remo Clear Pinstripe Marching Heads w/Crimplock

Item	Size	List	Sale
PS-0306-MP	6"	\$30.20	\$15
PS-0308-MP	8"	\$33.10	\$16
PS-0310-MP	10"	\$34.40	\$17
PS-0312-MP	12"	\$36.50	\$18
PS-0313-MP	13"	\$38.40	\$19
PS-0314-MP	14"	\$40.00	\$20
PS-0315-MP	15"	\$42.50	\$21

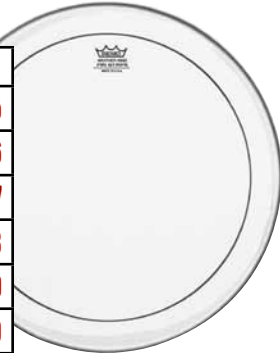

Clear Pinstripe w/Crimplock:

Two 7-mil plies of Mylar combined with patented dampening process. Legendary for its attack, projection and tone. Crimplock hoop is a hybrid design combining a crimped leg over the WeatherKing poured channel technology. Locks the film into the collar for added strength and durability in high-tension marching applications.



(Exclusions are noted)

Remo Marching Series

Item	Size	Description	List	Sale
KS-2613-00	13"	White Max	\$99.00	\$49
KS-0613-00	13"	Black Max	\$99.00	\$49
KS-2614-00	14"	White Max	\$101.40	\$51
KS-0614-00	14"	Black Max	\$101.40	\$51



Black & White Max: Combining an extremely durable Technora Aramid Fiber weave with reinforced counterhoop featuring Remo's Duralock technology. One of the most popular marching heads in the world. Perfect for all marching applications.

Remo Black Pinstripe Marching Heads w/Crimplock

Item	Size	List	Sale
PS-0406-MP	6"	\$30.20	\$15
PS-0408-MP	8"	\$33.10	\$16
PS-0410-MP	10"	\$34.40	\$17
PS-0412-MP	12"	\$36.50	\$18
PS-0413-MP	13"	\$38.40	\$19
PS-0414-MP	14"	\$40.00	\$20



Black Pinstripe w/Crimplock:

Two 7.5 mil film. Top ply of Ebony film combined with clear bottom ply. Built in ring reducing agent for tone control; improves sustain and heat resistance. Crimplock hoop design locks the film into the collar for added strength and durability in high tension applications.

Remo Hazy Timpani Heads

Remo Timpani heads have remained the choice of the world's leading tympanists for over 40 years. These are hazy with no insert ring.

The Best Way to Determine Size:

Remove the old head from the drum. Measure the outside diameter of the old head aluminum ring or flesh hoop. Keep in mind that timpani heads are measured differently from all other drum heads. Timpani heads are measured by the outside diameter of the entire drumhead; as if you were measuring it to fit in a box.

Model	Size	List	Sale
TI2300-00	23"	\$96.20	\$67
TI2400-00	24"	\$99.80	\$70
TI2500-00	25"	\$89.80	\$63
TI2600-00	26"	\$91.10	\$64
TI2800-00	28"	\$95.30	\$67
TI2900-00	29"	\$98.00	\$69
TI3000-00	30"	\$99.50	\$70
TI3100-00	31"	\$101.40	\$72
TI3200-00	32"	\$106.30	\$75
TI3300-00	33"	\$113.10	\$79
TI3400-00	34"	\$118.40	\$83

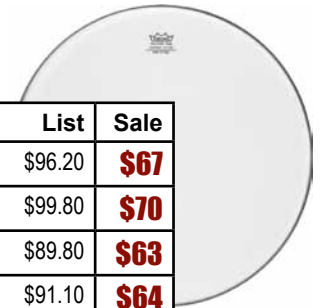

Remo Drumheads

Remo Ambassador Batter & Snare Heads

Item	Size	Description	List	Sale
BA-0113-00	13"	Batter - Coated White	\$29.10	\$15
SA-0113-00	13"	Snare Side - Hazy	\$26.80	\$13
BA-0114-00	14"	Batter - Coated White	\$31.80	\$16
SA-0114-00	14"	Snare Side - Hazy	\$28.40	\$14
SA-0115-00	15"	Snare Side - Hazy	\$29.10	\$15

Ambassador: 10-mil single ply head.
Perfect for outdoor & indoor drumming.

Coated: Medium weight made with coated single ply 10-mil Mylar film to produce a warm open, bright & resonant sound with warm attack. Standard of the industry for both live & recording situations.

Snare Side: A favorite for those seeking projection & tone, without compromising strength. Low-collar design capable of withstanding high tension. Single ply 3-mil Mylar film creates the perfect combination of strength, snare response & attack.



Remo Black Pinstripe

Two (10 & 5 mil) Mylar plies w/measured layer of a ring reducing agent applied between them at the outer edge of stripe to dampen high frequency overtones for warm resonance. Ideal heads for the "fat" sounds of Rock, R&B & for those who want more low end sounds with moderate attack & response characteristics.

Item	Size	List	Sale
ES-0606-PS	6"	\$36.90	\$18
ES-0608-PS	8"	\$38.30	\$19
ES-0610-PS	10"	\$39.70	\$20
ES-0612-PS	12"	\$41.70	\$20
ES-0613-PS	13"	\$42.80	\$21
ES-0614-PS	14"	\$45.20	\$23
ES-0615-PS	15"	\$46.50	\$23
ES-0616-PS	16"	\$49.90	\$25
ES-1616-PS	16"	\$85.30	\$43
ES-1618-PS	18"	\$90.20	\$45
ES-1620-PS	20"	\$94.80	\$47
ES-1622-PS	22"	\$99.00	\$49
ES-1624-PS	24"	\$104.20	\$52
ES-1626-PS	26"	\$110.80	\$55
ES-1628-PS	28"	\$115.80	\$58
ES-1630-PS *	30"	\$126.90	\$76

*Order & Ship Direct from Factory



Remo Smooth White Ambassador

Medium weight heads. Made with single ply 10-mil Mylar film. Produces open, warm resonant sounds with a warm attack. Great for all playing situations. An industry standard for marching bass drum applications.

Item	Size	List	Sale
BA-0212-00	12"	\$28.40	\$14
BA-0213-00	13"	\$29.10	\$15
BA-0214-00	14"	\$31.80	\$16
BA-0215-00	15"	\$34.00	\$17
BA-0216-00	16"	\$35.00	\$17
BR-1216-00	16"	\$63.20	\$32
BR-1218-00	18"	\$64.60	\$32
BR-1220-00	20"	\$67.20	\$34
BR-1222-00	22"	\$71.40	\$36
BR-1224-00	24"	\$76.20	\$38
BR-1226-00	26"	\$86.40	\$43
BR-1228-00	28"	\$93.80	\$47
BR-1230-00	30"	\$99.40	\$50
BR-1232-00	32"	\$107.60	\$54
BR-1234-00 *	34"	\$119.90	\$72
BR-1236-00 *	36"	\$130.20	\$82
BR-1240-00 *	40"	\$140.40	\$86

*Order & Ship Direct from Factory

Remo Clear Pinstripe

Two 7-mil plies of Mylar combined with patented dampening process. Legendary for its attack, projection and tone.

Item	Size	List	Sale
PS-0306-00	6"	\$26.80	\$13
PS-0308-00	8"	\$27.40	\$14
PS-0310-00	10"	\$28.60	\$14
PS-0312-00	12"	\$32.30	\$16
PS-0313-00	13"	\$33.10	\$17
PS-0314-00	14"	\$34.60	\$17
PS-0315-00	15"	\$36.30	\$18
PS-0316-00	16"	\$38.30	\$19
PS-1316-00	16"	\$70.80	\$35
PS-1318-00	18"	\$73.60	\$37
PS-1320-00	20"	\$74.80	\$37
PS-1322-00	22"	\$79.00	\$39
PS-1324-00	24"	\$83.70	\$42
PS-1326-00	26"	\$93.30	\$47
PS-1328-00	28"	\$100.80	\$50
PS-1330-00 *	30"	\$108.40	\$66

*Order & Ship Direct from Factory

Evans White Marching MX Tenor Heads

Item	Size	List	Sale
TT06MXW	6"	\$29.00	\$14
TT08MXW	8"	\$30.50	\$15
TT10MXW	10"	\$31.50	\$16
TT12MXW	12"	\$33.50	\$17
TT13MXW	13"	\$35.50	\$18
TT14MXW	14"	\$37.75	\$19

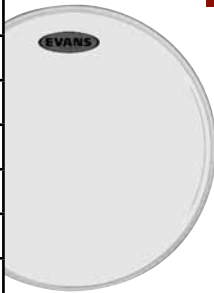

Evans Drumheads

Evans Corps Clear Tenor Heads

2 Ply of file for durability. 6.5 mil top ply. 10 mil bottom ply.

Item	Size	List	Sale
TT06CC	6"	\$25.75	\$13
TT08CC	8"	\$26.75	\$13
TT10CC	10"	\$27.75	\$14
TT12CC	12"	\$29.75	\$15
TT13CC	13"	\$32.25	\$16
TT14CC	14"	\$34.25	\$17

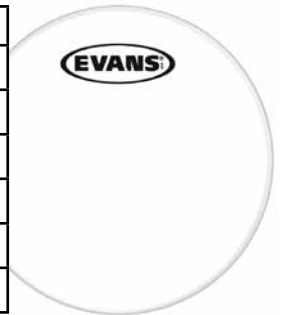

Evans System Blue Tenor Heads

Item	Size	List	Sale
TT06SB1	6"	\$27.75	\$14
TT08SB1	8"	\$28.75	\$14
TT10SB1	10"	\$29.75	\$15
TT12SB1	12"	\$32.25	\$16
TT13SB1	13"	\$34.25	\$17
TT14SB1	14"	\$36.25	\$18



Evans Custom Graphic Marching Heads

inkedbyevans.com

Show off your School Logo
 Customizable printing technology
 Multi-graphic options
 Available MX or MS Series; Sizes 14" - 32"
 Easy to Use online interface.



Evans Smooth White Marching MX1 Bass Heads

Item	Size	List	Sale
BD16MX1W	16"	\$85.75	\$43
BD18MX1W	18"	\$92.25	\$46
BD20MX1W	20"	\$98.50	\$49
BD22MX1W	22"	\$107.00	\$53
BD24MX1W	24"	\$115.50	\$58
BD26MX1W	26"	\$124.25	\$62
BD28MX1W	28"	\$137.00	\$68
BD30MX1W	30"	\$152.25	\$76

1 Ply
 Unique felt tone
 dampening system.

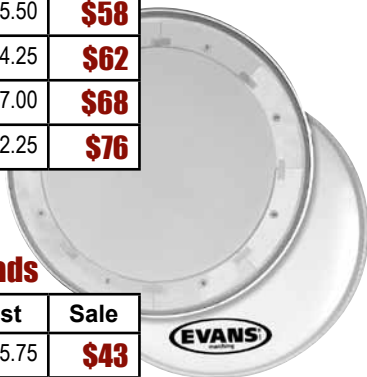

Evans MX1 Black Marching Bass Heads

Item	Size	List	Sale
BD16MX1B	16"	\$96.25	\$48
BD18MX1B	18"	\$102.75	\$51
BD20MX1B	20"	\$109.25	\$55
BD22MX1B	22"	\$118.00	\$59
BD24MX1B	24"	\$126.50	\$63
BD26MX1B	26"	\$135.00	\$67
BD28MX1B	28"	\$147.75	\$74
BD30MX1B	30"	\$162.75	\$81

1 Ply
 Unique felt tone
 dampening system.

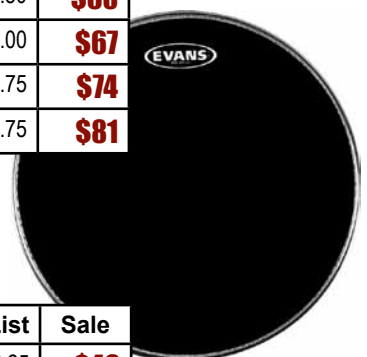

Evans Smooth White Marching MX2 Bass Heads

Item	Size	List	Sale
BD16MX2W	16"	\$85.75	\$43
BD18MX2W	18"	\$92.25	\$46
BD20MX2W	20"	\$98.50	\$49
BD22MX2W	22"	\$107.00	\$53
BD24MX2W	24"	\$115.50	\$58
BD26MX2W	26"	\$124.25	\$62
BD28MX2W	28"	\$137.00	\$68
BD30MX2W	30"	\$152.25	\$76

2 Ply
 Unique felt tone
 dampening system.

Evans MX2 Black Marching Bass Heads

Item	Size	List	Sale
BD16MX2B	16"	\$96.25	\$48
BD18MX2B	18"	\$102.75	\$51
BD20MX2B	20"	\$109.25	\$55
BD22MX2B	22"	\$118.00	\$59
BD24MX2B	24"	\$126.50	\$63
BD26MX2B	26"	\$135.00	\$67
BD28MX2B	28"	\$147.75	\$74
BD30MX2B	30"	\$162.75	\$81

2 Ply
 Unique felt tone
 dampening system.

Evans Snare Heads

Evans Hybrid Snare/Batter Marching Heads

Item	Size	List	Sale
SB13MHG Grey	13"	\$107.00	\$53
SB13MHSB Black	13"	\$96.25	\$48
SB13MHW White	13"	\$107.00	\$53
SB14MHG Grey	14"	\$115.50	\$58
SB14MHSB Black	14"	\$101.75	\$51
SB14MHW White	14"	\$115.50	\$58

Evans Snare Side Marching Heads

Item	Size	List	Sale
SS13MS3C MS Polyester material with 2 ml polyester flap	13"	\$27.75	\$14
SS14MS3C MS Polyester material with 2 ml polyester flap	14"	\$28.75	\$14
SS14MX5 Aramid Fiber Polyester Laminate w/thin overtone control ring	14"	\$95.25	\$48

Remo Muff'l Strips

MF9000 2 - 9' lengths of dense strips 1 1/4" x 7/8". Self-adhesive, pre-notched foam strips for ease of bending. Great for sound absorption.

\$29



Remo O's Sound Dampening Rings

RO-0014 14"

1 - 1" Wide; 1 - 1.5" Wide) **\$8**

RO-0236

Set of 4: 10", 12", 13", 16" **\$12**



Taylor Practice Pads

Tunable; Molded black plastic counter-hoop. Tensions like a drum. Rubber feet on bottom of pad for table top use. Can be used with or without a stand. Available Stand is tripod stand with height & angle adjustments, practice pad screws onto the top.

Item	Description	Sale
8TPP	8" Pad only	\$16
Set 8TPPS	Pad & Stand Set	\$44

Taylor Import Drumheads

Limited Quantities on Taylor Heads

Snare & Batter Heads

Item	Size	Sale
DH-314S Snare Side	14"	\$10
DH-114C Coated White	14"	\$10

Smooth White Tenor Heads

Item	Size	Sale
DH206	6"	\$9
DH208	8"	\$9
DH210	10"	\$9
DH212	12"	\$9
DH213	13"	\$10
DH214	14"	\$10
DH215	15"	\$12
DH216	16"	\$12

Smooth White Bass Heads

Item	Size	Sale
DH218	18"	\$15
DH220	20"	\$15
DH222	22"	\$20
DH224	24"	\$20
DH226	26"	\$24
DH228	28"	\$24

Gladstone Rubber Practice Pad

DPP-010 Rubber Snare Drum Pad 6" Raised middle section, 13.75" total diameter. Realistic rebound.

\$12



RealFeel Practice Pad

RF12D 12" Double sided gum & neoprene practice pad. It can rest on a tabletop or in a standard snare basket. It has a natural gum feel on one side for realistic rebound and a harder neoprene surface on the other for a real workout.

\$40



Rhythm Tech Laptop Snare

RT7600 Anytime, Anywhere Snare for playing and practice. 13" Diameter, 1" High. Weighs less than 1 lb. Includes black denier bag with strap.

\$63



Remo Practice Pads

Tunable; Molded gray Cyclocac counter-hoop. Tensions like a drum. Can be used with or without stand.

Item	Description	Sale
RT-0006-00	6" Pad only	\$20
RT-0008-00	8" Pad only	\$22
RT-0010-00	10" Pad only	\$28
Set RT/ST	Practice pad & stand (6", 8" or 10" pad)	\$65



Taylor Marching Drumsticks

Model	Description
TM/MS1	Oval tip, shorter taper; natural finish
TM/SRH	Barrel style tip, slightly longer taper; white finish



\$7 Pair
\$33 Set of 6 pair
\$55 Dozen

Taylor Concert Band Drumsticks

Model	Description
TM/2B	Standard length, shorter taper
TM/5B	Slightly shorter length, narrow taper



\$5 Pair
\$25 Set of 6 pair
\$44 Dozen

Vic Firth Corpsmasters Marching Drumsticks

Model	Description
SCM	Colin McNutt Oval tip, medium taper, natural finish
VFSRHJR	Ralphie Jr. Scaled down version, good for smaller hands, white finish
VFSRH	Ralph Hardimon Unique barrel tip, long taper, white finish
VFSLB	Lee Beddis Medium tear drop tip, short taper, natural finish



\$10 Pair
\$55 Set of 6 pair
\$99 Dozen

Promark American Hickory Concert Band Drumsticks

Model	Wood Tips
TX2B	Oval tip, 16" length, .630" diameter
TX5B	Oval tip, 16" length, .590" diameter
TX5A	Oval tip; slightly narrow, 16" length, .551" diameter
TX7A	Barrel tip, 15 3/8" length, .512" diameter
Model	Nylon Tips
TX2BN	Oval tip, 16" length, .630" diameter
TX5BN	Oval tip, 16" length, .590" diameter
TX5AN	Oval tip; slightly narrow, 16" length, .551" diameter
TX7AN	Barrel tip, 15 3/8" length, .512" diameter

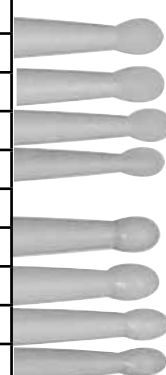

\$10 Pair
\$55 Set of 6 pair
\$99 Dozen

Vic Firth Corpsmaster Tenor Sticks

Model	Description
VFMTS1	Tenor Series Unique nylon tip pulls more sound from the drum and articulation with defined high timbre. (Formally known as Vega Tenor Stick)



\$12 Pair
\$66 Set of 6 pair
\$111 Dozen



Vic Firth Concert Band Drumsticks

Model	Hickory; Wood Tips
VF2B	Tear drop tip, 16 1/4" length, .630" diameter
VF5A	Tear drop tip, 16" length, .565" diameter
VF5B	Tear drop tip, 16" length, .595" diameter
Model	Maple; Wood Tips
VFSD1	General; round tip, 16 3/8" length, .635" diameter
VFSD2	Bolero; round tip, 15 3/4" length, .635" diameter
VFSD4	Combo; barrel tip, 15 7/8" length, .545" diameter

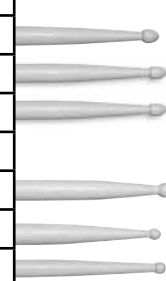

\$9 Pair
\$48 Set of 6 pair
\$90 Dozen

Innovative Percussion Marching Drumsticks

Model	Description
IPFS2	Field Series Reverse tear drop head, short taper, natural finish



\$10 Pair
\$55 Set of 6 pair
\$99 Dozen



IP-AT2M

IP-FT1

Innovative Percussion Marching Drumsticks

Designed for durability, projection & tone quality for marching.

Item	Description	List	Sale
IP-FT1	Field Series Multi-Tom, Pair Synthetic head, hickory shaft	\$46.00	\$23
IP-AT2M	Arena Series Multi-Stick, Pair Felt ball end & synthetic small disc end, hickory shaft	\$49.50	\$25

3160 3150 3151 3152



Drum Corp Marching Tom Mallets

Item	Description	List	Sale
3160	Marching Tom, Pair Aluminum shaft, 1/2" felt head, 15.5" long	\$35.00	\$21
3150	Marching Bass, Pair Aluminum shaft, 1/2" small felt head Use: 18" to 22" Drums	\$49.50	\$29
3151	Marching Bass, Pair Aluminum shaft, 2" medium felt head Use: 24" & 26" Drums	\$57.50	\$30
3152	Marching Bass, Pair Aluminum shaft, 2.5" large felt head Use: 28" to 32" Drums	\$67.50	\$36



Ludwig Concert Bass Mallets

Item	Description	List	Sale
L308	Payson Sostenuto, Each Extra large soft pile mallet, hard maple shaft	\$49.35	\$30
L309	Payson Roller, Pair Medium soft pile mallet, hard maple shaft	\$64.05	\$38
L310	Payson General, Each Medium soft white piano felt hand sewn over hard felt inner core, hard maple shaft	\$48.30	\$29
L319	Double Ball, Each Corkball (large & wood ball-small) soft pile mallet, hard maple shaft	\$87.15	\$50

Musser Keyboard Mallets

USAGE CODE

M = Marimba
X = Xylophone
B = Bells
V = Vibraphone



Item	Usage	Description (Pair)	List	Sale
M1	M	Rubber, Soft 1", Yellow	\$34.65	\$20
M2	M X	Rubber, Medium 1", Red	\$34.65	\$20
M3	M B X	Rubber, Medium Hard 1", Blue	\$34.65	\$20
M4	B X	Rubber, Hard 1", Gray	\$34.65	\$20
M5	B X	Phenolic, Hard 1", Brown	\$34.65	\$20
M6	X	Yarn, Hard 1", Red	\$49.35	\$30
M7	M	Yarn, Medium 1", Blue	\$48.30	\$29
M8	M	Yarn, Medium Soft 1", Yellow	\$48.30	\$29
M14	B	Brass, Very Hard 5/8", Gold	\$26.25	\$16
M16	V	Cord, Hard 1", Red	\$73.50	\$44
M17	V	Cord, Medium 1", Blue	\$68.25	\$40
M18	V	Cord, Soft 1", Yellow	\$69.30	\$42
M23	B X	Lexan, Very Hard 1 1/8", Clear	\$45.15	\$27

Ludwig Payson Timpani Mallets

Item	Description	List	Sale
L304	Ultra Soft, Pair	\$49.35	\$30
L305	Soft, Pair	\$49.35	\$30
L306	Medium, Pair	\$49.35	\$30
L307	Hard, Pair	\$49.35	\$30
L304-7	Set of 4: L304 to L307	\$197.40	\$115

Musser Rawhide Chime Mallet

M336 Traditional rolled rawhide with tapered hardwood handle.

\$25



Musser Chime Mallet

M337 Dual heads for differing timbres & oversized grip handle.

\$48



Innovative Percussion Chime Mallet

IP-CC1 Constructed on red oak handles with brass ring for added weight. One side of the beater head is covered with a felt cover for a soft timbre option.

\$30



Taylor Bell Mallets

3349 1 Pair Rubber bell mallets. Rubber ball on each end.

\$8



FREE SHIPPING
U.S. Contiguous
ON ACCESSORY
ORDERS OVER
\$75

(Exclusions are noted)

Zildjian Cymbal & Gong Mallets

Item	Description	List	Sale
SDMCMB	Classical Cymbal, Pair Versatile, yarn-wound head mounted on drumstick handle provides the perfect combination of fast response and soft pile sound. Black wood handles.	\$32.95	\$20
SDMCMN	Classical Cymbal, Pair Versatile, yarn-wound head mounted on drumstick handle provides the perfect combination of fast response and soft pile sound. Natural wood handles.	\$32.95	\$20
SDMSC	Suspended Cymbal, Pair Diamond shaped yarn heads produce smooth rolls & bright accents. Natural Wood Handles	\$49.95	\$30
SDMWGM	Wind Gong, Each Oval shaped, yarn wound head for smaller gongs.	\$49.00	\$30
P0550	Gong, Each Oversized diamond shaped head, designed for a wide variety of applications, produces maximum power	\$49.00	\$30



Vic Firth Timpani Mallets

Item	Description (Pair)	List	Sale
T1	General, All Around Work	\$51.45	\$29
T2	Cartwheel, Soft	\$51.45	\$29
T3	Staccato, Medium Hard	\$51.45	\$29
T4	Ultra-Staccato, Hard	\$46.20	\$27
T1-4	Set of 4 (1 pair of each)	\$200.55	\$110



Vic Firth Corpsmaster Marching Mallets

Item	Description (Pair)	List	Sale
MT1A	Multi-Tom Nylon head w/aluminum shaft	\$46.75	\$24
MT1AS	Multi-Tom Nylon head w/extra heavy duty aluminum shaft	\$50.15	\$25
MB0H	Bass Drum Sizes: 16", 18" Extra small felt head w/wood shaft	\$53.62	\$25
MB1H	Bass Drum Sizes: 18", 20", 22" Small felt head w/wood shaft	\$55.00	\$26
MB2H	Bass Drum Sizes: 22", 24", 26" Medium felt head w/wood shaft	\$59.40	\$27
MB3H	Bass Drum Sizes: 26", 28", 30" Large felt ball w/wood shaft	\$70.15	\$36
MB4H	Bass Drum Sizes: 30", 32", 34" Extra large ball w/wood shaft	\$78.10	\$38

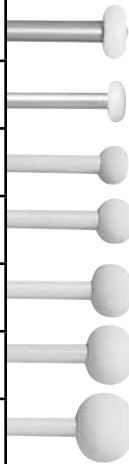

Corpsmaster Multi-Tom Mallets

Aluminum shafts offer excellent speed, response, durability & textured handles for enhanced gripping.

Corpsmaster Bass Drum Mallets

Tapered wood shafts shifts the weight of the stick towards the hand for improved balance & control. Textured handles for enhanced gripping.



Yamaha Educational Keyboard Mallets

Designed especially for students. Educational series provides an ideal combination of weight and balance perfectly suited for younger players. The hollow shafts are made of flexible, durable FRP material with non-slip finish.

Model	Description (Pair)	Sale
ME-103	Xylo/Marimba Med Hard, Rubber head	\$16
ME-202	Marimba Med Hard, Yarn Wound head	\$22
ME-302	Vibraphone Med Hard, Cord Wound head	\$24



Mike Balter Tom Mallets

MBMM2 - Pr. Marching Tom Mallets with Lexan ball and aluminum shaft.

\$28



Taylor Marching Bass & Tom Mallets

Item	Description (Pair)	List	Sale
TM/MT1	Multi-Tenor, Hard Felt Head Gold finished aluminum shaft with black rubber hand grips.	\$38	\$18
TM/JB1	Bass, Small Hard Felt Head Finished hickory wood shafts with rounded hard felt heads. Recommended Use: 16"-20" drums	\$43	\$22
TM/JB2	Bass, Medium Hard Felt Head Finished hickory wood shafts with rounded hard felt heads. Recommended Use: 22"-24" drum	\$47	\$23
TM/JB3	Bass, Large Hard Felt Head Finished hickory wood shafts with rounded hard felt heads. Recommended Use: 26"-28"	\$58	\$28
TM/JB4	Bass, Extra Large Hard Felt Head Finished hickory wood shafts with rounded hard felt heads. Recommended Use: 28" & up	\$63	\$30
TM/BB	Brass Bell Mallets Small 5/8" round brass head with black finished wood handles. Overall length = 14.5"	\$21	\$12

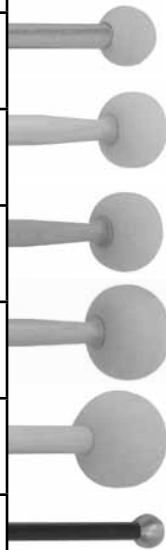

FREE SHIPPING
U.S. Contiguous

**ON ACCESSORY
ORDERS OVER
\$75**

(Exclusions are noted)



Taylor Concert Bass Mallet

CB700 Double End Bass mallet with wood shaft.

\$20



Taylor Timpani Mallets

TM1 For general, all-around playing. Round felt head 1.5". Total length 14.5" Pair.

\$15



Accent Sticks

Model	Description (Pair)	Sale
542L	Regal Tip Conga Sticks; leather covered with hickory handles.	\$35
SAA2	Vic Firth Alex Acuna Timbale Sticks. Purple. Made of hickory.	\$8
HROD	Promark Hot Rod Sticks; select birch dowels. Rubber handles & band.	\$17



Drum Brushes

Item	Description (Pair)	Sale
B600	Promark NyloBrushes. Nylon bristles with retractable plastic handles.	\$20
L191	Ludwig Wire Brushes. Red grooved handles with loop end.	\$22
VFWB	Vic Firth Wire Brushes. Retractable with textured white handles.	\$25
593C	Regal Tip Clayton Cameron Brushes. Non-retractable wire brushes. Comfortable rubber grip. Nylon butt end & metal stud for cymbal scrapes.	\$29



Innovative Percussion Keyboard Mallets

Fundamental Series

Pair. Designed with beginning percussionist and budget conscience band director in mind.

Item	Description	List	Sale
IP-F1	Marimba Soft Yarn w/black birch handles	\$30	\$16
IP-F1.5	Marimba Medium Yarn w/black birch handles	\$30	\$16
IP-F2	Marimba Hard Yarn w/black birch handles	\$30	\$16
IP-F5.5	Vibraphone Medium Cord w/rattan handles	\$50	\$27
IP-F6	Vibraphone Hard Cord w/rattan handles	\$50	\$27
IP-F9	Xylophone Rubber w/black birch handles	\$22	\$12

Jim Casella Series

Pair. Designed for indoor and outdoor marching percussion.

Item	Description	List	Sale
IP-1002	Marimba Medium Yarn w/rattan handles	\$49	\$30
IP-1003	Marimba Hard Yarn w/rattan handles	\$49	\$30
IP-1005	Vibraphone Medium Cord w/rattan handles	\$58	\$35
IP-1006	Vibraphone Hard Cord w/rattan handles	\$58	\$35

Field Series

Pair. Designed for durability, projection & tone quality for marching.

Item	Description	List	Sale
IP-FS250	Marimba Hard Yarn w/birch handles	\$47	\$28
IP-RFS420	Vibraphone Hard Cord w/birch handles	\$54	\$34
IP-FS650	Bells Hard Plastic w/birch handles	\$36	\$24

FREE SHIPPING
U.S. Contiguous
ON ACCESSORY
ORDERS OVER
\$75
(Exclusions are noted)

James Ross Series

Pair. Rattan Handles.

Designed for Concert Bells & Xylophones

Item	Description	List	Sale
IP-902	Red; Medium Soft	\$43	\$26
IP-904	Green; Hard	\$43	\$26
IP-905	Rust; Bright	\$43	\$26

Soloist Series

Pair. Birch Handles. 100% Wool wrapped heads.

Full rich tone w/warm fundamentals.

Designed for Marimba

Item	Description	List	Sale
IP-100	Soft	\$49	\$32
IP-200	Medium Soft	\$49	\$32
IP-240	Medium	\$49	\$32
IP-300	Medium Hard	\$49	\$32
IP-400	Hard	\$49	\$32

Rattan Series

Pair. Rattan Handles. Tightly woven multiply cord for strength & durability. Designed for Vibraphones.

Item	Description	List	Sale
IP-RS201	Soft	\$58	\$36
IP-RS251	Medium	\$58	\$36
IP-RS301	Hard	\$58	\$36

Concert Bass Mallets

Felt covered heads with red oak handles and brass ring for added weight.

Item	Description	List	Sale
IP-CB1	Each; Extra Large	\$60	\$32
IP-CB2	Each; Soft	\$56	\$30
IP-CB3	Each; Medium	\$54	\$28
IP-CB4	Each; Hard Rubber	\$50	\$26
IP-CB5	Pair; Rollers	\$71	\$40

Gong Series Mallets

Felt covered head with red oak handle and brass ring.

Item	Description	List	Sale
IP-CG1	Large	\$68	\$40
IP-CG2	Small	\$56	\$34

Boomwhackers Percussion Tubes

Boomwhackers Tuned Percussion Tubes are brightly colored plastic tubes. Tuned by length to music notes.

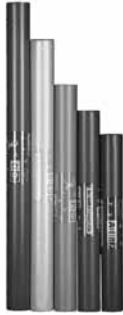

BWCG Chromatics Set

Consists of 5 Sharps/Flats for the standard octave. Tubes range in length from 13" to 23". It forms a different pentatonic scale. Has a pleasing sound. When combined with Diatonic Scale to create a full chromatic octave of 12 notes.

\$15.95



BWKG Bass Chromatic Set

Consists of 5 Sharps/Flats: C#, D#, F#, G#, A#. Bass notes.

\$29.95



BWDG C Major Diatonic Scale Set

Consists of 8 notes: C to C. Tubes range in length from 11" to 24". The most popular set and has won many awards including Parents Choice Foundation Best 25 Toys of 25 Years.

\$19.95

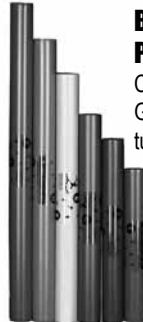

BWPG C Major Pentatonic Scale Set

Consists of 6 notes: C, D, E, G, A, C'. Brightly colored plastic tubes tuned by length.

\$19.95



BWEG Treble Extension Set

Consists of 7 tubes. Tubes start just above the highest note in the C Major Diatonic Scale Set: C#, D, D#, E, F, F# and G. Tubes range in length from 7" to 11".

\$12.95



BWJG Bass Diatonic Set

Consists of 7 notes: C to B. Tubes range in length from 26" to 47". The bass tubes add a new dimension to the sound and musical possibilities. Combine with the standard Diatonic set to form 2 full diatonic octaves.

\$39.95

BOOMWHACKERS®



Whack-A-Doodle Doo! Song Book

Books are designed with the musical notes; color coded to match the Boomwhacker Percussion Tubes. The colored notes enable anyone to easily play music as well as read music.

SB01 Volume 1

Designed for the standard Boomwhacker C Major Diatonic Set Percussion Tubes. Contains 19 familiar children's songs and 1 original song.

\$4.95

SB02 Volume 2

Designed for Boomwhacker C Major Diatonic Scale Set and Chromatics Set Percussion Tubes. The addition of the Chromatic notes allows a wider variety of songs. Contains 22 familiar children's songs.

\$3.95



(Exclusions are noted)



Boomwhacker Floor Stand

BWH13 Stand

Holds up to 13 Boomwhacker tubes.

\$9.95



OC8G Octavator Tube Caps (8 Pack)

The caps lower the tone of the tubes by an octave when placed on one end. The 8 Pack contains enough caps to use on any of the Boomwhacker sets.

\$7.95

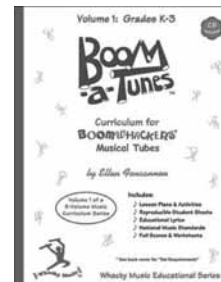

Boom-a-Tunes Curriculum Book

BT1B Book 1 with CD

Includes lesson plans and activities.

\$11.95



XT8G Xylo Tote Tube Holder

Holds 8 Boomwhacker Musical Tubes; a pair of mallets and a songbook or used as a Xylo Tote. Offers a new way to play your Boomwhackers like a xylophone. Made of cotton and elastic with hook and loop fasteners.

\$15.95



Latin Percussion Afuche/Cabasa

Constructed of endless loops of steel bead chain wrapped around a specially textured stainless steel cylinder. Wood flanges & handle. Designed to create rhythmic scraping sounds & patterns.

LP234A Standard **\$39.99**

LP234B Large **\$46.99**

LP234C Deluxe **\$53.99**



Latin Percussion Agogo Bells

Made of 18 gauge steel which gives a very bright Latin sound.

LP231A Standard **\$41.99**

LP231B Deluxe **\$43.99**



Latin Percussion Bell Tree

LP450 Bell Tree has 26 bells mounted on a steel stand. Can be quickly attached to any size post from 3/8" to 1" diameter. Bell tree mount comes with four cushioned feet for standing on table top. Complete with set of strikers.

\$285.99



Rhythm Tech Cabasa

RT8000 Made from genuine hardwood. Features a unique rubber grip for easier and more comfortable playing. Brass beads. Includes a linear pattern scraper (for a brighter more cutting sound) and chrome hardware.

\$30



Meinl Percussion Cabasa

CA7R Made of premium fiberglass and in the shape and function of a traditional gourd calabash. Red body color. Yellow w/Red bead color.

\$70

FREE SHIPPING
U.S. Contiguous
ON ACCESSORY
ORDERS OVER
\$75

(Exclusions are noted)



Latin Percussion Ice Bells

Made of custom alloyed cast brass. Bells have a brilliant attack and lingering sustain.

LP402 7" **\$60.99**

LP403 8.75" **\$80.99**



Latin Percussion Jam Bells

Produces a uniquely "pinched" dry sound which is a cross between an agogo bell and a cowbell.

Blue LP1231 High Pitch **\$31.99**
Red LP1233 Low Pitch

Rhythm Tech Barbells

RT8300 A versatile Bell Tree that can be hand-held, placed on a table or universal mount. 14 solid brass bells produce a shimmering effect. Striker included.

\$88



Latin Percussion Hand Held Bells

LP589 A hand held bell tree features 14 bells, with a solid wood handle and metal striker.

\$125.99

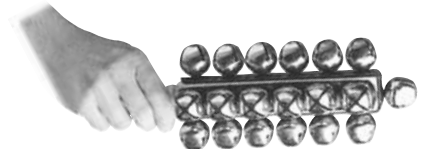

Latin Percussion Sleigh Bells

CP374 Deluxe, 25 steel bells mounted on large wooden handle. Produces a traditional jingle sound.

\$38

Latin Percussion Bar Chimes

Silver aluminum alloy bar chimes mounted with ties onto wood frame for proper balance. Includes bar chime striker & extra ties. Equipped with an exclusive anti-twist bracket that is mounted at the balance point of each bar to prevent movement.



Single Row

Model	Description	List	Sale
LP468	Handheld 12 Bar Cluster	\$62	\$39.99
LP449	Single Row 25 Bars	\$148	\$95.99
LP511	Single Row 36 Bars	\$202	\$132.99



Double Row

Model	Description	List	Sale
LP515	Dbl Row 50 Bars	\$247	\$160.99
LP513	Dbl Row 72 Bars	\$291	\$188.99



Latin Percussion Bar Chime Mounting Bracket

LP453 Steel construction and easily mounts to any 3/8" diameter rod.

\$19



TreeWorks Chime Mounting Bracket

TRE52 Designed to be used with all TreeWorks Chimes as well as other model chimes.

\$29



TreeWorks Chime Damper Bracket

TRE54 Bracket comes with built-in mount. Fully adjustable tension from light to full mute. Works on any brand of single row bar chimes.

\$55



Rhythm Tech Single Row Bar Chimes

RT8100 Single row 20 hardened aircraft quality aluminum bars. Anodized aluminum frame. Clear crystalline sound. Replaceable bar ties. List \$98.95

\$58

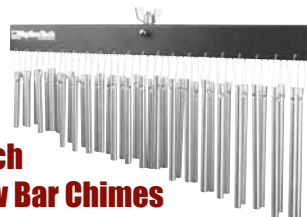

Rhythm Tech Double Row Bar Chimes

RT8102 Double row 40 hardened aircraft quality aluminum bars. Anodized aluminum frame. Clear crystalline sound. Replaceable bar ties. List \$140.95

\$82

Rhythm Tech Replacement Bar Ties

RT801 Set of 10 **\$3**

Latin Percussion Replacement Bar Ties **\$4**
LP470 Set of 24

TreeWorks Chime Cases

Thick, 1/2 inch, foam on both sides. The lining allows the chimes to slide in easily.



TRE51 Hard Side Gig Bag

Added protection of hard ABS plastic. Large #10 zipper on 3 sides. 2 Straps inside secure the chime by the Mantle allowing the chimes to hang naturally when carried by the molded handle. Inside usable space, 25.5" x 9.5".

Fits: Tre23, Tre23db, Tre24db, Tre24, Tre35, Tre35db, Tre44

\$44



LG24 Chime Case (23" Bag)

Fits: Tre24, Tre35, Tre35db
Will also fit other model chimes.

\$33

MD18 Chime Case (17" Bag)

Fits: Tre23, Tre44
Will also fit other model chimes.

\$30

TreeWorks Chimes

Developed and engineered by a percussionist frustrated by a scarcity of quality instruments, TreeWorks Chimes was founded in 1996 to provide musicians with the finest chime that can be made.



\$125

Single Row Classic

TRE35 Most popular and best-selling model. Full size TRE35 Single Row. Utilizes our T-6 tempered, custom aluminum/ titanium alloy bars (.375" diameter). List \$200



\$199

Double Row Classic

TRE35DB Double row version of the TRE35. 69 individually hand-tied bars. TreeWorks unique design allows each row to be played separately. A long sweep to both rows delivers a full, dramatic sound, while playing a single row provides a more modest flourish. Utilizes our T-6 tempered, custom aluminum titanium alloy bars (.375" diameter). List \$334



\$170

Single Row Concert

TRE630 w/Attached Damper & Gig Bag Professional single-row Concert Chime with attached damper. Good for all situations. Swing damper arm out where sound requires greater strength & resonance. Swing arm against the bars to silence the chimes quickly. Bars are aluminum/titanium alloy, polished & T-6 tempered for brilliant tone. TRE51 hard-sided gig bag. List \$283



\$135

Studio Chime

TRE44 Thin Bar

Full size chime delivers an extended sweep. In studio settings or for acoustic performances if needing a less aggressive sound and clear resonance. Utilizes T-6 tempered, custom aluminum/ titanium alloy bars in thinner, .25" diameter. List \$225



*Limited Quantities Available

Yamaha 32 Note Bell Set

SPB30 Table Top 32 Note Bells. 2.5 Octave. Range F to C. 1" Wide aluminum bars with note identification stamped on bottom side. Bars mounted on sturdy frame with compressed felt nodal supports. Includes Yamaha SPM20 dual head bell mallets.
****NO Stand or Carrying Bag Included**

\$95

STAND OPTION:

Musser Keyboard-Bell Stand

LE1368 Sturdy chrome orchestra bell stand with 4 support arms.

\$85



Latin Percussion Flexatone

A unique instrument that creates a wave of eerie, saw blade-like sounds through varied pitches. Bend the spring steel with thumb pressure as the wooden balls strike the surface.

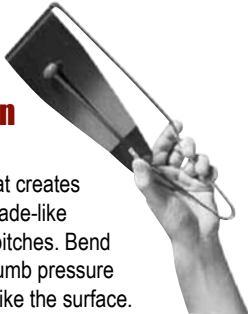

LP1-5 Small \$30.99

LP1-8 Large \$42.99



Latin Percussion Vibraslap

Rosewood chamber. Nice percussion sound effects.

LP208 Standard \$46.99
Smaller Chamber

LP209 Deluxe \$51.99
Larger Chamber

Latin Percussion Cowbells

Crafted from premium quality steel. Mount feature forged eye bolt clamp assembly with oversized wing nut provides secure placement.



Description	Sale
LP204A 5" Black Beauty Most Popular. High pitched bright sound with moderate overtone.	\$29.99
LP205 8" Timbale Low pitch. Moderately dry sound.	\$39.99
LP206A 8" Bongo Deep pitch. Rich, moderately dry sound.	\$42.99
LP229 8.5" Mambo Deeper pitch. Drier tone.	\$39.99

Pearl New Yorker Cowbells

Designed to create the signature salsa sound. Volume & durability to handle any musical situation.



Description	Sale
BCM-3NY Cha Cha High Pitch	\$38
BCM-5NY Cha Cha Low Pitch	\$38
BCM-7NY Mambo	\$44
BCM-8NYQ Timbal Marc Quinones Signature Bell. The ultimate salsa campana bell.	\$48

Meinl Percussion Cowbell Beaters

Rippled grip. Made of rubber wood. Natural finish.

COW1 Natural \$5

COW2 Padded \$9



FREE SHIPPING
U.S. Contiguous
ON ACCESSORY
ORDERS OVER
\$75

(Exclusions are noted)



Taylor Black Cowbells

Black, Heavy duty steel construction.

LC4BK 4.5 \$16

LC5BK 5" \$18

LC6BK 6.5" \$20

LC7BK 7.5" \$25



Rhythm Tech Studio Series Cowbells

Made from a single piece of steel. Featuring the Rock Lock mounting system with its unique eyebolt and wing nut design.

RT3005 5" \$22
5" Small Cha-Cha Style. Higher pitched, dry sound.

RT3008 8" \$27
8" suited for louder rock and deeper tone.

Latin Percussion Super Guiro

LP243 Durable. Molded from high strength plastic. Designed to have shape, feel and sound quality of the natural gourd. Includes two scrapers; a plastic model for bright loud sound and a wood model for warm dry sound. Can be mounted on drum or percussion table with LP Mic Claw LP529A-N.

\$44.99

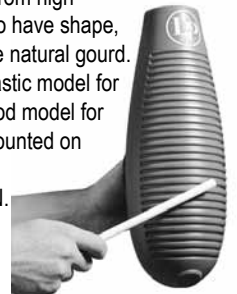

Taylor Fish Shape Guiro

TMFG Tri-color fish shape wood guiro. Large size with scratcher.

\$15



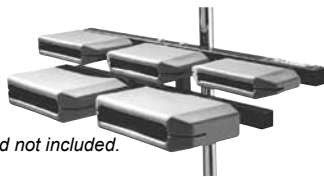

*Stand not included.

Latin Percussion Granite Blocks

LP1210 Set of 5

Tuned to traditional Chinese wood temple blocks; virtually unbreakable. Universal mount allows an over-under configuration or in straight traditional orchestral mount. Includes universal mounting bracket to fit on any cymbal stand.

\$223.99

Latin Percussion Stand

LP332 Designed to hold a variety of mountable percussion. 21" long telescoping 3/8" diameter knurled rod can hold jam blocks, bar chimes & cowbells, all at once with room to spare. Chrome plated with double braced legs & rubber feet.



\$110

Black Swamp Wood Blocks

Select Grade Rock Maple. Grain is oriented vertically on soundboard; resistant to cracking and splitting.



Model	Description	Sale
MWB0	Ex. Lg; deep, full sound	\$45.00
MWB1	Large; full, resonant tone	\$42.75
MWB2	Medium; traditional sound	\$40.50
MWB3	Small; bright, round tone	\$39.00
MWB4	Tiny; chipper tone	\$36.75
MWBM	Multi-Clamp Mount Kit	\$28.60



Pearl Elite Concert Wood Blocks

Produces vibrant wooden tone when struck. Made of Para wood and finished with clear lacquer.

PCWB-100A Small **\$27**

PCWB-200A Medium **\$31**

PCWB-300A Large **\$37**



Ludwig Temple Blocks

LE104 Synthetic, Set of 5

Built for durability and maximum sound projection, these synthetic blocks are the perfect alternate option to wood. Clamp mounts to most cymbal stands. Mallets are included. (Stand is not included)

\$155

Latin Percussion Jam Blocks

Made of specially formulated plastic-jeniger. Unique design offers the ideal pitch and volume. Blocks are virtually indestructible.



LP1205 High Pitch, Blue **\$29.99**

LP1207 Medium Pitch, Red **\$33.99**

Rhythm Tech Moon Blocks

RT3400 Indestructible, synthetic, wood-block sounding instrument with a raised playing surface; makes it easy to hit the "sweet spot". Great for cross stick effects, clave parts, cowbells or a DST. Can be mounted on a pedal bracket to be played with a foot operated beater.



\$28



Meinl Percussion Wood Blocks

Black rubber wood material. Matte finish. Rounded playing surface. Beater included.

MWB1BK Medium **\$16**

MWB2BK Large **\$20**

Meinl Percussion Claves

CL1RW Pr Classic Wood Claves. Redwood. Most commonly used model. Produces classic cutting sound.

\$10

CL7R Pr Fiberglass Claves. Premium fiberglass. Red in color. Produces a penetrating, loud and cutting sound.

\$40



Black Swamp Temple Blocks

Solid ash block body; bent into a unique, rounded shape. Birch plywood finish on sides. Solid wood makes for better sound. Includes Mounting Bar. Stand not included.

Model	Description	List	Sale
TBSET5	Set of 5 Blocks	\$798	\$598
TBSET6	Set of 6 Blocks	\$945	\$709
TBCASE	Travel Case *Specify 5 or 6 Block Set when ordering.	\$506	\$329

*Fits on any cymbal stand.

Order & Ship Direct from Factory



Black Swamp Castanets

Pair. New design; NO strings. Elastic free tension system. T-shaped spring steel; as tension knob is tightened it presses down on spring steel which opens castanets. Loosening the knob reduces tension. 7/8" Large.

PCC3-GD Grenadilla **\$123.75**

PCC3-RW Rosewood **\$133.50**



Toca Castanet Machine

T2300 Two Pair independently adjustable castanets mounted on an exclusive Toca mechanism. Special mounting provides control over articulation and response. Playable with fingers or soft mallet. Stand is mountable.

\$58



Latin Percussion Standard Claves

LP211R Pair; Made of strong exotic hardwoods, cut-away sound chamber yields a loud, deeper, drier sound.

\$31.99

Latin Percussion Jingle Sticks

LP180 Black Pair 6 double steel alloy jingles mounted in rows. Use to strike cymbals, jam blocks, drums or play against your legs for controllable patterns. Bright tone.

\$26



Latin Percussion Pro Maracas

LP281 Matched pair (one high pitch; one low pitch). Features bright, loud sound with vibrant yellow plastic shells & wood handles.

\$22.99



Rhythm Tech Maracas

FML/M Set of 2 Pair
Large & mini fiber maracas.
Use the large for a dry, present sound.
Use the mini for a lighter, tighter sound.

\$18



Meinl Percussion Traditional Maracas

MSM3 Set of 2
Made of natural rawhide with wooden handle.
Produces a full, dry sound.

\$50



Meinl Percussion Studio Maracas

PM1BK Set of 2
Black; made from special plastic material.
Clear and crisp tone with a comfortable handle for absolute control.

\$30



Yamaha Slapstick

YS200 Features sonic projection holes to ensure perfect timing and realistic sound.

\$28



Taylor Slapstick

3465 18" Hinged wood slapstick.

\$22

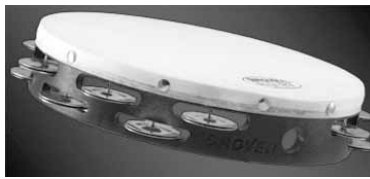

Grover Projection Plus Tambourines

10" Premium natural skin head, glued & tacked to solid, steam-bent hardwood shell. Hand-hammered jingles are mounted in a staggered double row arrangement. Includes soft case & roll ring.

Model	Jingle Material	List	Sale
T2/GS	German Silver	\$227	\$170.25
T2/PhBr	Phosphor Bronze	\$227	\$170.25
T2/BC	Beryllium Copper	\$252	\$189.00

Grover Sound Value Tambourine

SV-Tamb 10" Natural skin head. 8 ply maple shell. Quality stamped double row brass alloy jingles. Includes softcase and roll ring.

\$74.90



Grover Roll Rings

GV-RR Allows perfect thumb roll. Easily & quickly attaches to any 10" diameter tambourine. Thanks to the reusable PSA backing it can be put on and taken off a number of times.

\$12.75



Black Swamp Tambourines

High quality calf head absorbs less moisture in humid conditions than white calf heads. Solid ash shell. Manufactured with steam bent, solid ash shell. Ergonomic handle design. Dual sized jingle slots allow more seamless shake rolls. Custom fit with hand hammered jingles.

Model	Description	List	Sale
TC1	Chromium 25 & Phosphor Bronze; fuses articulation of Chromium w/warmth of Bronze. Unique & versatile sound.	\$233	\$175
TC2 *	Chromium 25 & German Silver; bright texture with sustain of German silver & crunch of Chromium	\$240	\$180
TD1	Chromium 25; dry & crunchy with maximum articulation & projection	\$233	\$175
TD2 *	Phosphor Bronze; dark, warm texture with significant jingle sustain	\$233	\$175
TD3 *	German Silver; bright for a very traditional tambourine sound	\$240	\$180
TD4 *	Beryllium Copper; balancing sustain and warmth for a full sonority	\$265	\$199

* Order & Ship Direct from Factory

Rhythm Tech Tambourines

Half Moon Hand-Held Style

RT1010 Black
Plastic shell. Double row of eight pairs of nickel jingles.

\$28



Half Moon Mountable Style

DST10 Black
Plastic shell. Double row of 8 pairs of nickel jingles. Mounts securely on any stand with 1/4" or 1.5" rod.

\$28



SOLO 1/2 Moon Style Crescent

RT1210 Black
Plastic shell. Single row of 8 pairs of nickel jingles. Narrow grip for younger players.

\$14



****Other colors available. Special Order Only**

Taylor Tambourine

TB10D 10" Calfskin head; natural color. Laminated wood frame. Double row jingles.

\$24





Grover Triangles

Designed and crafted to produce a variety array of spectral colors. Resonate with varied complexities of overtone resonance. Considered state of the art by discriminating percussionists.

Model	Description	Sale
TR6	6" Super Overtone	\$67.50
TR9	9" Super Overtone	\$73.50
TRB4	4" Bronze Piccolo	\$37.10
TRB5	5" Bronze Concert	\$38.50
TRB6	6" Bronze Concert	\$39.90
TRB7	7" Bronze Symphonic	\$41.30
TRB8	8" Bronze Symphonic	\$42.70
TRB9	9" Bronze Symphonic	\$44.10



Grover Triangle Beaters & Mounts

Model	Description	Sale
TB-S	Standard Alloy 6 Pc Set	\$49.50
TB-D	Deluxe Alloy 10 Pc Set	\$76.50
TB-TS	Standard Tubular 4 Pc Set	\$49.50
TB-TD	Deluxe Tubular 6 Pc Set	\$76.50
SV-TC	Plastic Triangle Clip	\$11.20
PTC	Pro Triangle Clip (Wood)	\$25.50
DTM	Dual Triangle Mount	\$47.25

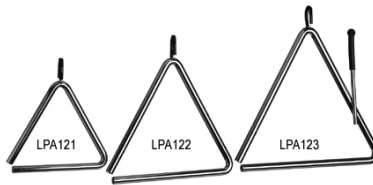
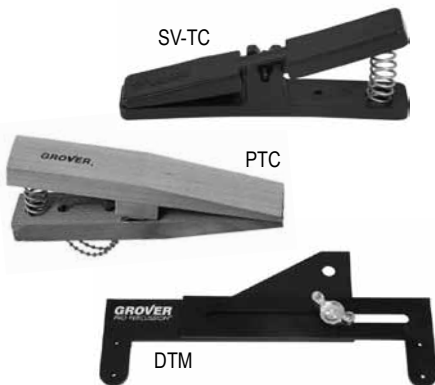

Latin Percussion Supreme Triangles

Heavy gauge steel delivers rich, broad sound. Includes striker.

LPA121 6"	\$18
LPA122 8"	\$20
LPA123 10"	\$24



Ludwig Triangle Clip Holder

\$12

LE1336 with Spring Clamp



Rhythm Tech Trigger Triangles

RT6000 Allows the player more speed & precision by supporting the triangle while being played. 5" high carbon triangle & striker.

\$28



Black Swamp Triangle Beaters

Set of 3 Includes one of each: SET3 (Light), STB3 (Med), STB4 (Med Heavy) Traditional rod style beater. Excellent for general use with colored vinyl grip for easy identification.

\$60

Danmar Triangle Strikers

DAN506 Set of 3 Strikers

\$14



Alan Abel Triangles

The best quality materials produce these high end, symphonic quality triangles. The finest triangles created by Alan Abel, Former Principal Percussionist of the Philadelphia Orchestra for over 38 years.

Model	Description	Sale
AAOT3	Orchestral 4" Small Thinly orchestrated music	\$48
AAST6	Symphonic 6" Medium All around playing	\$80
AAWH6	Wagner/Mahler 6" Symphonic Heavier, darker sound	\$88

*Beater & Clamp not offered by Alan Abel Refer to other brands offered.

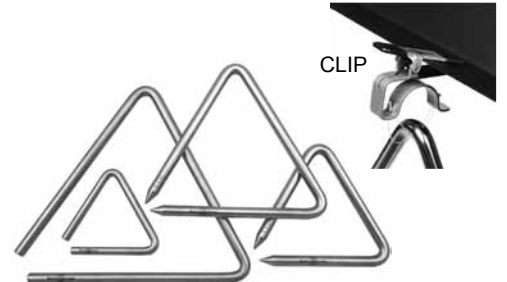

Black Swamp Artisan Triangles

Steel, versatile dynamic range and remarkable tone. For superior general use. Each size produces a shimmering and consistent overtone spectrum throughout its' entire dynamic range.

Model	Description	Sale
AT4	4" Light; delicate passages	\$69
AT6	6" Versatile; general use	\$82
AT8	8" Large Sound; general use	\$86
AT10	10" Huge Sound; general use	\$92
TRCLIP	Triangle Clip with vinyl caps	\$55



Meinl Percussion Triangle Holder

MC-TRI A simple but effective way to place the triangle in the percussion set-up. Made of chrome plated steel and features a knurled surface and nylon cord.

\$9.50



Acme Percussion Whistles

High quality sound effect whistles. Essential for every percussion section for specialty numbers. Available individually or as a set.

Model	Description	Sale
4218	Wooden Train Whistle	\$6
TH5912NP	Director's Whistle	\$15
TH572	Duck Call Sound Effect Whistle	\$15
302	American Metal Slide Whistle	\$16
TH499	Nightingale Whistle	\$43
TH147NP	Siren Whistle	\$45
TH451	Siren Horn	\$82
Set of 7	Set of 7 Percussion Whistles. <i>Includes</i> One of each of the above Whistles	\$211



(Exclusions are noted)

Meinl Percussion Rainsticks

Natural Bamboo makes these rainsticks pleasant effect instruments. Plenty of projection and long sustain. May be played like big shakers.

- RS1BKS 16" Small Black **\$15**
- RS1RM 24" Medium Red **\$19**
- RS1BKL 39" Large Black **\$25**
- SRS1RL 39" Synthetic Lightweight **\$30**



Toca Rainsticks

Beautifully crafted. Hand applied artwork. Made of Bamboo.

- T-RAIN24 24" Medium **\$24**
- T-RAIN39 39" Large **\$29**



Dobani Circular Bulb Horn

BULH 2.75" Bell, 14" length. Solid brass with removable rubber bulb and metal reed. Great honk. Uses a bulb with a 5/8 inch fitting.

\$25

Latin Percussion Pro Shekere

LP483 Durable white fiberglass body, wrapped with a lattice of Jenigor plastic beads. Most durable & dependable shekere made. Loud, high-pitched shaker & rattle sound. Large fiberglass body, thick neck & wide mouth produce extremely low bass tones. A rubber ring surrounds shekere mouth to protect it. Attractive black & red beads, hand strung in the finest traditional fashion and white body.



\$140.99

Meinl Percussion Large Shaker

SH9LS Large, Round Shaker. Made of anodized aluminum. Silver color. Designed to cut through loud music.

\$25



Rhythm Tech Eggz Shakers

Small egg shaped shakers! Fun, easy to play with. Great sound for recording and acoustic use.

Options:

- RT2110 Black **\$2 each**
- RT2111 Multi-Color **\$18 Dozen**

Rhythm Tech Shakers

RT2015/RT2019

Set of 2 5" & 9" feature unique internal ridges that control the feel of the instrument and create a dry, crisp present sound.

\$22



Taylor Ratchet

4876 Metal ratchet with clamp to fit bass drum hoop and a hand crank.

\$25

Meinl Percussion Artist Shakers

Designed according to master percussionist Luis Conte's exact requirements. Features 2 individual shakers connected as one. Made from plastic. Medium size.

- Options:
- SH4BK Live (79-81 decibels); Black color
- SH5R Studio (72-76 decibels); Red color
- SH45GR Field (88-93 decibels); Gray color

\$15



***In Stock**



Meinl Percussion Headliner Series Wood Bongos

Made of Eco-friendly rubber wood. High gloss finish. Hand selected buffalo heads. 8mm strong tuning lugs. Interior backing plates. 2mm rounded rims. Black powder coated hardware. Includes tuning key.

Options:

HB100-MA Maple

Size: 6.75" x 7"

HB100-NT Natural

Size: 6.75" x 8"

\$95

THBS-BK Bongo Stand Only \$94.99

Double braced.

***Factory Order**



Latin Percussion Matador Timbales

M257 Chrome Plated Shells.
Double braced heavy duty tilting stand. 14" & 15" Drum sizes. Includes cowbell, tuning wrench and pair of timbale sticks. List \$579

\$376

***In Stock**



Meinl Percussion Headliner Series Wood Congas

HC555 Set 10" & 11" Compact size. Light to carry. Full, rich sound. Made of Eco-friendly rubber wood. Natural high gloss finish. Includes tuning key. Meinl style tuning brackets. Hand selected buffalo heads. 8mm strong tuning lugs. 2mm round rims. Black powder coated hardware. Height adjustable basket style stands with quick set up system.

Options:

HC555 Maple

HC555 Natural

HC555 Vintage Sunburst

HC555 Wine Red Burst

\$350

***Factory Order**



Latin Percussion Matador Bongos

M201/M245 Matador Bongos with Stand. Constructed of kiln dried siam oak. Dark rich lacquered finish. Skin style heads. Bongo stand easily mounts bongos on tilting bracket. Double braced legs. List \$446

M201/M245 Bongos with Stand \$255

M201B Bongos Only \$165

M245S Stand Only \$115

***Factory Order**



Pearl Timbales

PTS5134 Primero
13" x 6.5" & 14" x 6.5"
Steel drums.
Includes tilting stand, sticks & cowbell. List \$579

\$255

PTE1415DX Primero Pro 14" x 7" & 15" x 7" Steel drums. Includes tilting stand & sticks. List \$615

\$279

***Factory Order**

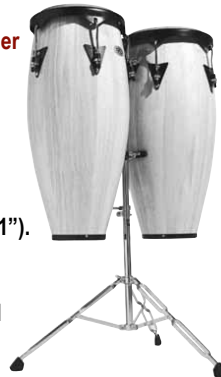

Latin Percussion Aspire Congas

Set of two drums (10" & 11"). Deluxe construction. Wood shells. Tunable skin heads. Heavy duty chrome finished steel stand. List \$649

Options:

LPA646AW Natural Wood

LPA646RW Red Wood

LPA646DW Dark Wood

LPA646VSB Vintage Sunburst

\$425

***In Stock**



Meinl Percussion Headliner Series Wood Cajons

Size: 11.75" Wide x 18" High x 11.75" Deep. Adjustable top corners, Adjustable sizzle effect. Anti-slip sitting surface. Includes Allen wrench.

HCAJ1-NT Natural

Resonating body and front plate made of rubber wood with Matte finish.

\$110

HCAJ1-AWA

Stained American White Ash
Resonating body made of Eco-friendly medium density fiberboard. Stained American White Ash front plate.

\$120

Pearl Cajons

***Factory Order**

PBC507 Primero Box

Constructed of Asiatic Pine with adjustable snares. Gypsy Brown matte lacquer finish. List \$245

\$125



PCJ629 Jingle

Designed by Peter Korpela. Fiberglass construction. Features built-in platinela and tambourine jingles; can be engaged for incredible sound with fixed snares. Carubinga exotic wood lacquer finish. List \$332

\$165



PCJ633BB630 Boom Box

Fiberglass construction. Fixed snares. Features built-in bass port; magnifies subsonic frequencies for never before heard lows. Red Sparkle finish. List \$399

\$195



PBC512TF Two Faced

Pro Wood construction. Fixed snares. One face is 5mm thick offering a more mellow woody sound. The reverse face is 3mm thick gives all the punch, thump and crack desired. List \$419

\$210



Zildjian®



ZBT Starter Cymbal Package

ZBTS3P Zildjian's Bronze Technology, offers great sounding, bright and focused cymbals. Perfect for beginners looking for a great sound at a low price! List \$462

Package Includes:

- 1 Pr. 13" Hi Hats
- 1 Ea. 18" Crash Ride

\$189.95 Pkg



ZHT Pro Cymbal Package

ZHT390 Zildjian's Superior Sheet Bronze Cymbals offers more distinct models than any previous Zildjian sheet bronze selection. Each reflects unique lathing lines and distinctive hammering patterns designed to accentuate their sound properties. Cymbals are fast, bold, bright and powerful. List \$1015

Package Includes:

- 1 Pr. 14" Mastersound Hi Hats
- 1 Ea. 17" Fast Crash
- 1 Ea. 20" Medium Ride

\$369.95 Pkg



A. Zildjian Cymbal Package

A390 The standard by which all other cymbals are judged. Cymbals have a spectrum of tonal colors with a powerful, full bodied sound. List \$1825

Package Includes:

- 1 Pr. 14" New Beat Hi Hats
- 1 Ea. 16" Thin Crash
- 1 Ea. 20" Medium Ride

\$679.95 Pkg



A. Zildjian Cymbals

Model	Description	List	Sale
A0133	14" New Beat Hi Hats, Pr.	\$582	\$339.95
A0223	16" Thin Crash, Ea.	\$352	\$199.95
A0022	18" Crash Ride, Ea.	\$415	\$239.95
A0034	20" Medium Ride, Ea.	\$476	\$274.95

Zildjian Rebate Offer

Ask us how to get **FREE** Cymbals!
Call for Details!

Zildjian 2015 SCHOOL MUSIC PROGRAM

LEVEL 1

Zildjian Cymbal and/or Gen16 Cymbal purchases totaling \$550 or more. Total purchase amount before taxes. Does not include Crotales or cymbal accessories. **Choice of 1 Cymbal*, up to 18" in diameter.**



LEVEL 2

Zildjian Cymbal and/or Gen16 Cymbal purchases totaling \$1100 or more. Total purchase amount before taxes. Does not include Crotales or cymbal accessories. **Choice of 2 Cymbals*, or 1 matched pair, any size.**



LEVEL 3

Zildjian Cymbal and/or Gen16 Cymbal purchases totaling \$2750 or more. Total purchase amount before taxes. Does not include Crotales or cymbal accessories. **Choice of 6 Cymbals*, or 3 matched pairs, any size, any combination.**



*Cymbals include: A Zildjian, A Custom, K, K Custom, Sound FX, ZHT, ZXT, ZBT, and Gen16. K Constantinople, K Keropa, and K Symphonic Cymbals are excluded from this free offer.

Combined qualifying Zildjian purchases must be completed within a 12 month time frame. This Award Certificate form must be postmarked no later than 60 days from date of last qualifying purchase. Purchase award amounts are subject to change at any time without notice.

FREE SHIPPING
U.S. Contiguous
ON ACCESSORY ORDERS OVER \$75

(Exclusions are noted)

Zildjian Specialty Cymbals

Classic Orchestral Selection

Thin to medium thin with medium taper for quick response & decay.

Model	Description	List	Sale
A0412	14" Suspended, Ea	\$343	\$199.95
A0417	16" Suspended, Ea	\$416	\$239.95
A0419	18" Suspended, Ea	\$488	\$284.95
A0421 *	20" Suspended, Ea	\$560	\$319.95



Symphonic Selection

Possesses all sonic ingredients that are expected. Clear full bodied response provides all that is needed in concert hall.

Model	Description	List	Sale
0427 *	18" French Tone, Pr.	\$832	\$479.95
0447 *	18" Viennese Tone, Pr.	\$832	\$479.95
0490 *	18" German Tone, Pr.	\$832	\$479.95
0429 *	20" French Tone, Pr.	\$952	\$549.95
0449 *	20" Viennese Tone, Pr.	\$952	\$549.95
0492 *	20" German Tone, Pr.	\$952	\$549.95



Special Effects Selection

Model	Description	List	Sale
0211	10" Splash	\$201	\$114.95
0354 *	18" China (High)	\$436	\$249.95
0344 *	18" China (Low)	\$436	\$249.95

* Cymbals Ordered From Factory. Delivery 2-4 Weeks



Zildjian Zmac Cymbals

Multi-Application. Full, High, Bright & Rich in Harmonic Structure. Cymbal weight varies.

MULTI-APPLICATION CYMBALS

Model	Description	List	Sale
0471	14" Medium Heavy, Pr.	\$582	\$339.95
0475	16" Medium Heavy, Pr.	\$704	\$399.95
0477	18" Medium, Pr.	\$832	\$479.95
0479 *	20" Medium, Pr.	\$952	\$549.95

* Cymbals Ordered From Factory. Delivery 2-4 Weeks



Zildjian Sheet Bronze Band Cymbals

Sheet Bronze Metal. Good tone & quality at affordable prices.

Marching & Concert Band Cymbals

Model	Description	List	Sale
ZBT14BP	14", Pair	\$212	\$119.95
ZBT16BP	16", Pair	\$278	\$149.95
ZHT18BP	18", Pair	\$466	\$259.95



A. Zildjian Concert Stage Cymbals

Model	Description	List	Sale
0444	16" Concert, Pr.	\$704	\$399.95
0454	18" Concert, Pr.	\$832	\$479.95
0466 *	20" Concert, Pr.	\$952	\$549.95

* Cymbals Ordered From Factory. Delivery 2-4 Weeks

Concert Stage Cymbals:

A perfect blend of quick, responsive overtones over a wide sonic spectrum. Ideal for contemporary concert band composition. The profile offers a new shape & allows for easy playability for all levels of concert performers.

ALL PAIRS of CYMBALS includes FREE
 Pair Zildjian Pads & Leather Straps
 (Choose from Leather or Faux Wool Pads)



Zildjian Stadium Medium Cymbals

Model	Description	List	Sale
0452	14" Medium, Pr.	\$582	\$339.95
0468	16" Medium, Pr.	\$704	\$399.95
0483	18" Medium, Pr.	\$832	\$479.95
0485 *	20" Medium, Pr.	\$952	\$549.95

Zildjian Stadium Medium Heavy Cymbals

Model	Description	List	Sale
0487	16" Medium Heavy, Pr.	\$704	\$399.95
0495	18" Medium Heavy, Pr.	\$832	\$479.95
0497 *	20" Medium Heavy, Pr.	\$952	\$549.95

* Cymbals Ordered From Factory. Delivery 2-4 Weeks

Stadium Cymbals:

Specially designed for Contemporary Drum Corps & Marching Bands. Brilliant top finish, Traditional bottom finish.

Sabian Marching Cymbals

AAX Arena Series

Pair - Medium Weight offers projection, articulate attack & controlled sustain. Heavy Weight offers maximum projection, percussive attack & long controlled sustain. *Specify Natural or Brilliant (B) finish when ordering.

Model	Description	List	Sale
21822X (B)	18" Medium	\$792	\$479
22022X (B) *	20" Medium	\$930	\$559
21825X (B)	18" Heavy	\$792	\$479
22025X (B) *	20" Heavy	\$930	\$559

* Cymbals Ordered From Factory. Delivery 2-4 Weeks



B8 Pro Series

Pair - Moderately priced Medium Weight; ideal for smaller bands. Brilliant finish.

Model	Description	List	Sale
31422B	14" Band	\$266	\$149
31622B	16" Band	\$352	\$199
31822B	18" Band	\$406	\$219



AA Arena Series

Pair - Medium Heavy Weight. Full bodied sound w/long decay. *Specify Natural or Brilliant (B) finish when ordering.

Model	Description	List	Sale
21422 (B)	14" Marching	\$560	\$309
21622 (B)	16" Marching	\$696	\$379
21822 (B)	18" Marching	\$792	\$439
22022 (B) *	20" Marching	\$930	\$519

* Cymbals Ordered From Factory. Delivery 2-4 Weeks



B8 Series

Pair - Bright yet musical; controllable by young percussionists. Affordable for all programs. Natural finish.

Model	Description	List	Sale
41422	14" Band	\$228	\$129
41622	16" Band	\$298	\$159
41822	18" Band	\$346	\$189



ALL PAIRS of CYMBALS includes FREE Straps

Sabian Concert Cymbals

AA Concert Series

Pair - Medium Weight. More penetrating. Offers greater multi-purpose applications. Vintage Style; bright sound. *Specify Natural or Brilliant (B) finish when ordering.

Model	Description	List	Sale
21621 (B)	16" Concert.	\$676	\$379
21821 (B)	18" Concert	\$792	\$439



XS20 Concert Series

Pair - High Performance with low cost. Delivers bright, musical sounds with articulation & projection. *Specify Natural or Brilliant (B) finish when ordering.

Model	Description	List	Sale
XS1421 (B)	14" Concert	\$330	\$199
XS1621 (B)	16" Concert	\$436	\$259
XS1821 (B)	18" Concert	\$500	\$299
XS2021 (B) *	20" Concert	\$592	\$359



* Cymbals Ordered From Factory. Delivery 2-4 Weeks

ALL PAIRS of CYMBALS includes FREE Straps

AA Symphonic Series

Pair - Medium thickness & weight. Produces full sound with more decay. Vintage Style; bright sound. *Specify Natural or Brilliant (B) finish when ordering.

Model	Description	List	Sale
21819 (B)	18" French	\$792	\$439
21820 (B)	18" Viennese	\$792	\$439
22020 (B)	20" Viennese	\$930	\$519

* Cymbals Ordered From Factory. Delivery 2-4 Weeks



HH Symphonic Series

Pair - Medium weight. Produces full sound with moderate decay. Vintage Style; dark sound. *Specify Natural or Brilliant (B) finish when ordering.

Model	Description	List	Sale
11819 (B)	18" French	\$1068	\$639
12019 (B)	20" French	\$1228	\$739
11820 (B)	18" Viennese	\$1068	\$639
12020 (B)	20" Viennese	\$1228	\$739
11824 (B)	18" Germanic	\$1068	\$639
12024 (B)	20" Germanic	\$1228	\$739

* Cymbals Ordered From Factory. Delivery 2-4 Weeks





Sabian High & Low Octave Crotales

Full Octave sets include universal mounting bar to fit cymbal stand. 13 tuned discs made of B20 bronze. Tuned to A+442. List \$2935 per Set

Options:

50303H High Pitch Set

50303L Low Pitch Set

\$1759 Per Set

\$3518 Set of 2 (Both High & Low)

*Attaches to Cymbal Stand, Pg 54



Zildjian High & Low Octave Crotales

Produces clear, unblemished notes when played. Definite chromatic pitch. Crafted from Zildjian alloy. Used to interpret special sounds in classical percussion ensembles and contemporary music. 13 Bells with mounting bar. Range: Middle C on the piano up two octaves. List \$2274 per Set

Options:

P0615/0637 High Pitch Set

P0625/0636 Low Pitch Set

\$1155 Per Set

\$2222 Set of 2 (Both High & Low)

*Attaches to Cymbal Stand, Pg 54



Zildjian Crotales Bag

P0638 Durable black canvas carrying bag with foam padding. Zildjian logo embroidered in gold. Holds one octave (set) only. List \$329

\$169



Zildjian Cymbal Cleaner

P1300 Cymbal cleaning polish will clean, polish and protect all your Zildjians, Cast or Sheet, Brilliant or Traditional Finish with the exception of ZXT Titanium.

\$10



Ludwig Sling Shot Cymbal Holder

L1392 Pair Sling Shot Grips pouch and ball design allows for simple assembly as they eliminate having to do any tying.

\$18



(Exclusions are noted)



TreeWorks Finger Cymbals

TRE01 Studio Finger Cymbal Tree with beater bar. Mounting bracket included. List \$133

\$85



Sabian Cymbal Pads & Straps

Model	Description (Pair)	Sale
61001	Black Leather Pads	\$17
61002	Black Leather Straps	\$15
61002EZ	Black Leather EZ Straps	\$18
61001/2	Black Leather Pads & Straps	\$32



Zildjian Finger Cymbals

Matched pair made from natural cast. Produces a piercing, high-pitched ring. Outfitted with a red felt bag for storage. List \$29.95

Options:

P0771 Thick (Higher Pitch)

P0773 Thin (Lower Pitch)

\$18



Zildjian Cymbal Pads & Straps

Model	Description (Pair)	Sale
P0751	Black Leather Pads	\$18
P0753	Soft Wool Pads	\$24
P0750	Black Leather Straps	\$15
P0750/P0751	Black Leather Pads & Straps	\$33
P0750/P0753	Wool Pads & Leather Straps	\$33

Sabian Symphonic Gongs

Produces a powerful & sturdy fundamental note which is enhanced & softened by harmonic overtones. Creates a full, warm and round response. Very tonal. Medium Heavy weight. **Stand & mallet not included.**

Model	Size	List	Sale
52402	24"	\$552	\$329
52602	26"	\$659	\$389
52802	28"	\$748	\$449

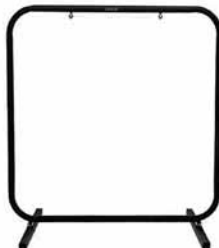

Sabian Gong Stands

Model	Description	List	Sale
SGS26	Small; fits up to 26"	\$130	\$89.95
SGS40	Large; fits up to 40"	\$165	\$119.95
SGS40GS	Large with Wheels; fits up to 40"	\$245	\$169.95

World Percussion Chao Gong

Classic Chinese Gong. Wonderful, rich full bodied tone. Volume builds to impressive levels. Sustain is long creating a feeling of warmth & harmony, versatile deep gong voice & tones. General purpose use for orchestra & band. **Includes Stand** made of durable square tubing, easy to assembly with compact tear down for easy transportation & storage. Includes gong mallet.

Model	Description	Sale
CG24S	24" Gong & Stand (no wheels)	\$335
CG26S	26" Gong & Stand (no wheels)	\$375
CG28S	28" Gong & Stand (with wheels)	\$555

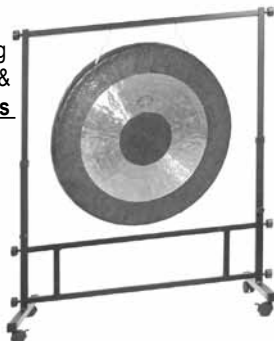

WUHAN Chau Gongs & Stands

Crafted with an ancient process that has essentially not changed since they started. Gongs have a bold sound with bulls-eye design. **Stand & mallet not included.**

Model	Description	List	Sale
WU007-26	26" Gong	\$650	\$355
WU007-28	28" Gong	\$850	\$455
WU007-30	30" Gong	\$1050	\$585
WU007-32	32" Gong	\$1195	\$655
WU007-34	34" Gong	\$1590	\$895
WU007-36	36" Gong	\$1725	\$955
WU332A	Stand 26"-36" (No Wheels)	\$180	\$110
WU322B	Stand 26"-36" (w/Wheels)	\$290	\$175



Sabian Chinese Gongs

Traditionally hammered for oriental sound. Produces a definite impact response followed by an outpouring of raw, dark overtones. Full sounding. Medium Heavy weight.

Model	Size	List	Sale
53001	30"	\$909	\$549
53401	34"	\$1531	\$919
54001	40"	\$2607	\$1569



Sabian Gong Mallets

Yarn wrapped mallet.

Model	Description	Sale
61004S	Small	\$50
61004L	Large	\$55

**Gongs & Stands
Factory Order
Allow 2-4 Weeks**

FREE SHIPPING
U.S. Contiguous
ON ACCESSORY
ORDERS OVER
\$75

(Exclusions are noted)



Zildjian Orchestral Gongs & Stand

One-piece, cast, hand-hammered construction. Complex blend of highs and lows with beautiful warm overtones and plenty of attack. Includes P0560 gong stand. (Mallet Not Included)

Size/Description	List	Sale
P0499 26" Gong w/Stand	\$1086	\$545
P0500 30" Gong w/Stand	\$1286	\$655
P0501 34" Gong w/Stand	\$1737	\$875
P0502 40" Gong w/Stand	\$2586	\$1295
P0560 Stand Only Holds gongs up to 40". Black matte finish; 2 mallet hooks. Locking wheels. Dimensions: 45" x 58". List \$287		\$155

Zildjian Gong Mallets

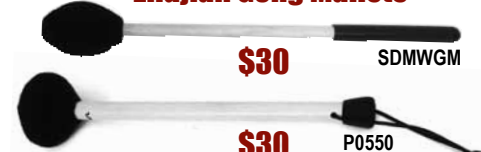

\$30

SDMWWG

\$30

P0550

Accessories
not included.



Pearl Percussion Toy Box Accessory Tray

PTYB-1212 Case & Trap Table in One!
Aluminum frame mounted in lid attaches to music or
cymbal stand to hold small percussion. List \$175

\$99



Rhythm Tech Mountable Accessory Tray

RT7500 13" x 7.5" Clamp-on, Accessory
percussion tray. Heavyweight unit clamps solidly to
any stand to insure a stable surface. Features soft,
no slip silent neoprene surface with side rails to keep
everything in place. 2 quick grab utility hooks for
hanging tambourine, triangle, etc. List \$68.95

\$40



Meinl Percussion Trap Table

Offers enough room for all common hand percussion
instruments. Tables are made of premium fiberglass.
Height adjustable and has a fabric anti-slip surface.

Model	Description	List	Sale
TMPTS	16" x 22" Trap Table with double braced stand	\$268	\$170
TMPETS	20" x 34" Trap Table with double braced stand	\$314	\$200

Accessory Trays

Taylor Wood Trap Table

Wood shell covered table with black vinyl covering.
Plush black lining on all sides & bottom to eliminate
noise. Table size: 18.75" x 24" x 3" deep.

TT Trap Table Only \$55

TTOS Trap Table with Stand \$99

Double braced stand made of black
metal tubing; adjustable to 5 positions;
up to 38" high.



Accessories
not included.



Pearl Trap Table

Nice carpeted table for your percussion accessories.
Comes complete with a clamp for stand mounting.
Features cutouts to keep sticks from rolling off.

Model	Description	List	Sale
PTT-1212	12" x 12" Trap Table only	\$85	\$55
PTT-1824	18" x 24" Trap Table with single braced stand	\$240	\$145
PT-1824W	18" x 24" Trap Table with double braced stand	\$275	\$165
PTR-1824	Add on Rack for PTT-1824	\$285	\$170

Factory Order
Allow 2-4 Weeks

Meinl Percussion Workstation

TMPWS Designed to be customized
according to the player's demand. Height
adjustable, angle adjustable top bar. Fabric
anti-slip surface. Heavy duty construction.
Expandable. List \$780

Includes:

- 1 - 22" x 24" Fiberglass Table
- 2 - 18" x 12" Fiberglass Tables (attachable)
- 1 - 30" Vertical Bar
- 2 - 15" Vertical Bars (attachable)
- 4 - Straight Rods with hook
- 3 - Angled Rods with hook
- 1 - Z-Shaped Rod with hook

\$500

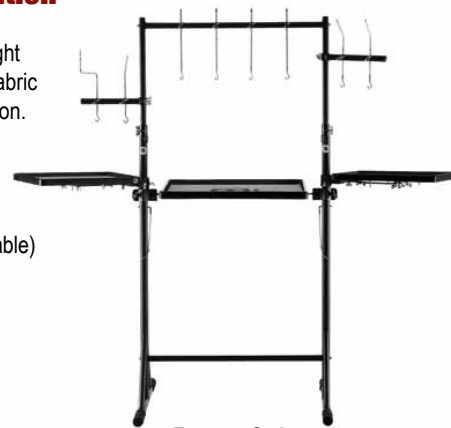

Factory Order
Allow 2-4 Weeks



Rhythm Tech Percussion Mount

Nice addition for adding cowbells, tambourines, etc.

Model	Description	Sale
RT7903	Sideman Attaches to drum tuning screw. Quick set up & tear down. Perfect for marching band & corps.	\$14
RT7904	DSM Quad Mount Includes 4 bent rods for mounting accessories. Holds up to 8 items.	\$32



LP Percussion Mounts

New & Improved claw mounts. A must for marching. Gives you ability to mount percussion items with ease.

Model	Description	Sale
LP592S-X	Splash Cymbal Claw with Z-Arm Holds up to 16" cymbals	\$39.99
LP592B-X	Percussion Claw with Z-Rod Clamps to any standard snare or bass rim	\$39.99
LP236C	Percussion Mount All Bracket Holds any mountable percussion accessory	\$33.00
LP236D	Chime Mount All Bracket Ideal for bar chimes. Mounts to anti-twist plate	\$26.00

Discontinued LP Percussion Mounts

While Supplies Last

Model	Description	Sale
LP592S	Splash Cymbal Claw with Z-Arm Holds up to 16" cymbals	\$29
LP592B	Percussion Claw with Z-Rod Clamps to any standard snare or bass rim	\$29



(Exclusions are noted)

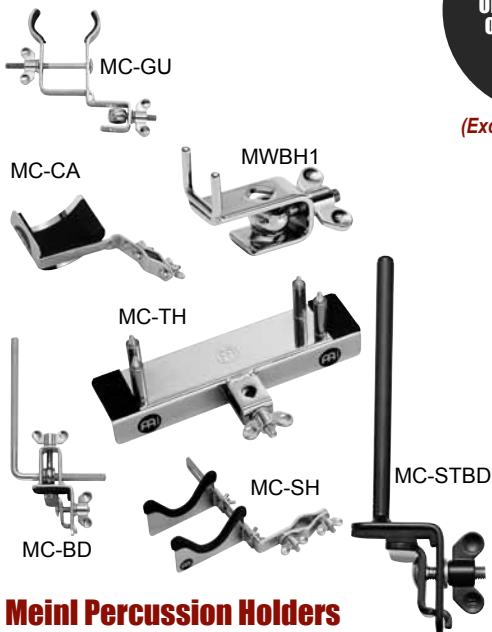

Meinl Percussion Holders

Model	Description	Sale
MC-TH	Tambourine; Chrome	\$20.00
MWBH1	Wood Block Holder; Chrome	\$8.50
MC-BD	Cowbell Holder; Chrome	\$23.00
MC-STBD	Cowbell Holder; Black	\$15.00
MC-GU	Guero Holder; Chrome	\$25.00
MC-CA	Cabasa Holder; Chrome	\$25.00
MC-SH	Shaker Holder; Chrome	\$30.00
MC-TRI	Triangle, Chrome (pg 44)	\$9.50



Yamaha Folding Bass Drum Stand

BS125 Portable folding bass stand.

\$166



Yamaha Tilttable Bass Drum Stand

Tilttable with casters. List \$994

BS7051 Fits 28" & 32"

BS7053 Fits 36" & 40"

\$577

Yamaha Bass Stands
Factory Order
Allow 2-4 Weeks



Yamaha Rolling Bass Drum Stand

BS425 Semi-Portable rolling stand.

\$344



Yamaha Tough Terrain Bass Drum Stand

T-CBASS Tough Terrain Frame for Yamaha concert Bass Drums. Adapts to most concert bass drums of various sizes. List \$1188

\$677



*In Stock

Ludwig Folding Bass Drum Stand

LE790 Simple to fold and store, this hollow metal stand offers dependable support. Rubber sleeves insulate the drum for pure sound and provide a no-slip grip. Adjusts to fit 28" to 36" drums.

\$119

LUDWIG®



Ludwig All Terrain Tilting Bass Drum Stand

LE787 Features 1.5" square steel construction, silver vein powder coated. Fits all brands of concert bass drums from 28" to 40" diameters. Positive tilt action secured with insulated large bass drum mount castings. Height adjustable. Equipped with retractable foot rest. Includes 4 large 5" locking swivel castors for easy transportation both indoors and out. List \$885

\$485



Ludwig All Terrain Bass Drum Stand

LE788 Made from 1.5" square steel tubing. Includes fully variable tilting adjustment with reliable angle locking casters, for 32" to 40" drums. List \$1050

\$585

Jarvis, Ludwig & Pearl Bass Stands
Factory Order
Allow 2-4 Weeks



Pearl Folding Bass Drum Stand

CBS-15 X-style design is lightweight and allows for easy portability. Adjustable to fit drums 28" to 36". Rubber sleeves protect drum finish and allows clear tone.

\$119



Pearl Suspended Bass Drum Stand

Offers a rubber band, total free-floating mounting system allowing for unprecedented drum resonance and sustain. Includes foot rest bar, limitless angle tilt and detachable suspension ring into two halves allowing for convenient transport. List \$1230

STBD-28 - 28" Bass

STBD-32 - 32" Bass

STBD-36 - 36" Bass

STBD-40 - 40" Bass

\$579

STBD-36F - 36" Bass with
Endurance Field Frame Wheels

\$629



Jarvis Tilting Bass Drum Stand

1304-2 Tilts and locks at any angle. No metal to metal contact. Supplied with clamps and eyebolts for your choice of suspension. 8" pneumatic tires, diagonal brace, black enamel finish.

\$795

**Truck Shipping costs additional.*



Pearl Tilting Bass Drum Stand

CBS-38C w/Casters

Unique design cradles hoops on 3 rubber cushions (nothing touches the shell allowing for free resonance). Adjustable to accommodate bass drums from 14" to 24" in depth. Adjustable drum angle. Foot rest for player comfort. List \$540

\$249



Pearl Direct Mount Tilting Bass Drum Stand

Sturdy yet lightweight tube frame with direct bolting attachment to Bass Drum. Large tube type, locking swivel adjustment for drum angle. Four large easy rolling, lockable wheels for convenient positioning. List \$980

CBS-80S (fits 32")

CBS-80M (fits 36")

\$459

Ludwig Concert Snare Stands

LM923SSC Concert
Modular Series Heavy duty Stand. Wide stance double braced legs. Large serrated non-slip rubber crutch feet. Unique collar clamp height adjustment system. Triple chrome plated.

\$125



Yamaha Concert Snare Stands

SS745A Concert
Medium weight stand. Single braced. Height adjustable 23" to 35".

\$95



Taylor Hardware Stands

Doubled braced hardware. Rubber grip feet.

Model	Description	Sale
6000S	Deluxe Snare. Heavy duty. Height adjustable to 26".	\$65
6000CS	Concert Snare. Heavy duty. Height adjustable to 36".	\$85
6000C	Deluxe Cymbal. Multi-position tilter. Height adjustable.	\$65
6000BC	Deluxe Boom Cymbal. Multi-position tilter. Height adjustable.	\$80
6000H	Deluxe Hi Hat. Direct chain pull. Adjustable tension, height & clutch.	\$95

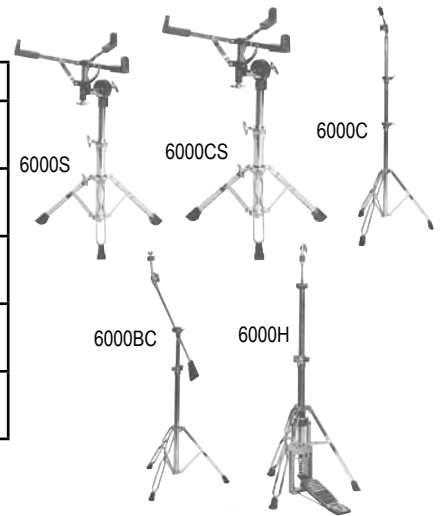

Pearl Concert Gooseneck Cymbal Stands

C1000SC Freely suspended mounting for cymbals up to 20". Single braced legs. Leather suspension straps slips through for holding cymbal securely.

\$118



Gibraltar Concert Cymbal Stand

7614 Concert stand holds one pair of cymbals up to 22". Rubber covering on arms protects cymbals and eliminates noise resonance. Large grip rubber feet.

\$88



Pearl Concert Snare Stands

S700L Concert
Single braced stand. Heavy rubber feet. Features Geared Tilting system. Height adjustable 23" to 34".

\$70



S1030L Concert
Double braced stand. Heavy rubber feet. Features Gyro Lock Tilting system. Extended shaft for standing/concert play. Height adjustable 21" to 29".

\$126

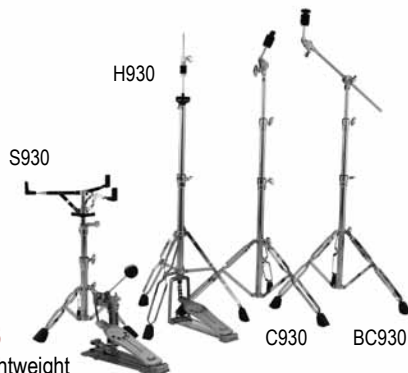

Pearl 930 Series Stands

New Trident design tripod base. Lightweight double braced hardware. Non-slip rubber feet.

Model	Description	List	Sale
S930	Snare Stand, 18.1"-21.6" Height	\$119	\$60
C930	Cymbal Stand w/uni-lock tilter	\$139	\$75
BC930	Boom Cymbal Stand w/uni-lock tilter	\$159	\$80
H930	Hi Hat Stand; demonator style	\$219	\$99



Discontinued Pearl Hardware Limited Stock

Model	Description	List	Sale
C1000	Pro Cymbal Stand - Straight w/ uni-lock angle adjustment system. Heavy duty double braced.	\$209	\$99
B1000	Pro Boom Cymbal Stand with uni-lock angle adjustment system. Heavy duty double braced.	\$239	\$104

Pearl Drum Throne

D790 Thickly padded round vinyl covered cushion, die cast seat bracket for security and durability. Double braced legs with rubber grip feet. Stoplock height adjustments: 16.9" to 25.6"
List \$119



*In Stock

\$75

Pearl Roadster Drum Throne

D1000SPN Double Braced with Shock Absorber. Designed for maximum comfort. Provides a radical shock absorber that will add energy to every movement.
List \$299



Factory Order
Allow 2-4 Weeks

\$149

Pearl Timpani Throne

D3000TC Professional grade timpani throne has a robust pneumatic cylinder for infinite height adjustment from 25" to 33". Solid cast 5 leg base with adjustable feet for uneven surfaces with independently adjustable foot ring. Generously padded seat and full size adjustable back rest. Can be used for Conductor Seat, Double Bass and Keyboards.
List \$515.50



Factory Order
Allow 2-4 Weeks

\$259

Discontinued
Limited Stock



Taylor Drum Throne

TTH1 Chrome plated, heavy duty double braced legs. Adjustable height; 19" to 25". Turn & lock position. Thick padded saddle style seat. Top covered with black plush velvet material & leatherette side covering.

\$85

Roc N Soc Cycle Seat Drum Thrones

Comfortable, handcrafted, quality seating. Famous Cycle Seat made of high grade foam. The shape helps prevent leg fatigue. Cloth seat panel to prevent sweating or slipping. Quality vinyl trim for durability.

Seat Cover Colors: Black, Blue, Grey, Red

Model	Description	List	Sale
LSG	Lunar Cycle Seat Gas lift throne with 5 leg base stability. Very sturdy. Height adjustable 19" to 27".	\$220	\$159.50
NR	Nitro Cycle Seat Most Popular Model. Compact throne with nitrogen gas shock absorber for bounce in the seat. Height adjustable 18" to 24". Double braced legs.	\$230	\$166.75
MS	Manual Cycle Seat Spindle height control. Height adjustable 18" to 24".	\$210	\$152.25

Factory Order Allow 2-4 Weeks



LSG



NR



MS



(Exclusions are noted)



Taylor Felt Pedal Beater

TM/FPB Hard felt head with metal shaft.

\$16

*Factory Order



Pearl Eliminator Drum Pedal

P2000C Dual Chain Drive

Interchangeable cams. Includes case.
List \$309

\$189

*Factory Order



Pearl Demon Drum Pedal

P3000D Direct Drive

Convertible short/long footboard. Includes case. List \$529

\$299

\$59



Discontinued
Limited Stock

Pearl Drum Pedal

P900 Single Pedal

Heavy duty model, PowerShifter, single chain, round cam, new P2000 look footboard, black posts. Heavier DuoBeat Beater, P2000 Spring w/new spring hook, nylon cam holder, spring tension rubber washer, ultragrip clamp bolt, power plate. List \$149

\$59

Musser Keyboard-Bell Stand

LE1368 Sturdy chrome orchestra bell stand with 4 support arms.

\$88



Majestic Bell Stands

Bell Stand for B3525S and B3525A Orchestra Bells.

MFS25 Folding \$60

MRS25 Rolling

33" x 22" table
25.5" - 39" height adjustability.
List \$590

\$355



Factory Order
Allow 2-4 Weeks



Factory Order Allow 2-4 Weeks

Yamaha Bell/TrapTable Stand

YGS100 Rolling bell stand/trap table.

Table Size: 31" x 19"

Height Adjustment: 27" - 33"

List \$630

\$377

Taylor Keyboard Stand

KS15B Black metal XX style stand with rubber feet & top rubber style grips for holding keyboards.

5 Adjustments for height and width:

11.75" wide x 39" tall

34" wide x 22.5" tall

\$55

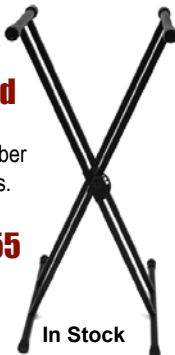

Musser Marching Field-Pit Stands

Cross Style, black metal marching Pit stands.

Model	Description	Sale
LFP302BKS *	Concert Bells & Keyboards	\$95
LFP301XMS *	Marching Xylophones, Marimbas	\$130
LFP103PBS *	Cradle/Tilting Style Bass	\$165

* Factory Order Allow 2-4 Weeks

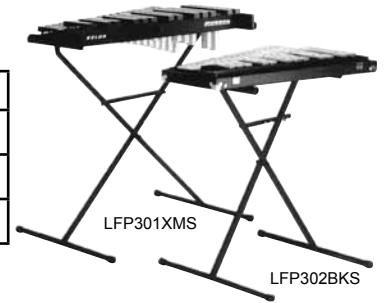

Musser Marching Tom & Snare Stand

LFP101TSS Cross Style
Black metal marching Pit stand.

*In Stock

\$125



Pearl Marching Stands

Rock solid stability. Features height/range independently adjustable front leg to facilitate performances on level ground and bleachers. Designed for Pearl CX Airframe and MX T-Frame carriers.

Model	Description	Sale
MSS3000	Snare Drum fits Championship Series only	\$142
MTS3000	Multi Tom/Quad fits Championship Series only	\$158
MBS3000	Bass Drum	\$155

Factory Order Allow 2-4 Weeks



Randall May Stadium Stands

Designed for older Pearl Championship Series carriers.

Model	Description	Sale
RSMHSP	Snare Drum	\$155
RSMHQ	Multi Tom/Quad	\$177
RSMHBP	Bass Drum	\$188

Factory Order Allow 2-4 Weeks



Yamaha Stadium Stands

Exclusive Air Suspended Telescoping Tube!
Telescoping tube glides up and down effortlessly. Features a tripod system that allows one leg to adjust independently of the other two for stable support of drums even in bleachers.

Model	Description	Sale
RSMHSA	Snare	\$166
RSMHQA	Multi-Tom/Quad	\$188
RSMHBA	Bass	\$199

Factory Order Allow 2-4 Weeks





Jarvis Mallet Mover Only

1075-3 Hard durable black finish. Constructed of welded 2" square tubular steel. Diagonal brace for stability. 8" Ever Roll wheels provide easy transport across most terrains.

\$675

*Specify Make, Model & Instrument Length

1001-1 Vibe Pedal Bracket Add **\$55**



Jarvis Band Wagon Size Mover Kit

1306-1 Size 4" x 8" Build Your Own!

Kit includes:

- (4) 10" pneumatic tires
 - (4) 4" aluminum railings
- Steel frame. Strong steel tongue with hitch. All necessary hardware & building instructions. (Plywood not included on this model.)

\$795



Jarvis Mallet Mover with Percussion Rack

1301-2 Allows additional instruments to be mounted. Hard durable black finish. Constructed of welded 2" square tubular steel. Diagonal brace for stability. Anodized aluminum bar & two mounting clamps to secure bar. 8" Ever Roll wheels provide easy transport across most terrains. Mounting clamps not included.

*Specify Make, Model & Instrument Length

\$795



Jarvis Mobile Platform Mover

1092-3 Size 5" x 8"

All steel frame with plywood bed. Plywood bed sits 5.5" off ground. 500 lb load capacity. (6) 8" Ever Roll wheels. 4" railings with provisions for tiedowns. Strong steel tongue. Easy towing with ATV, golf cart, garden tractor or by hand. Folds for easy rolling through doorways. Stores on caster wheels for minimum storage.

\$1495



Jarvis Utility Band Wagon Mover

1077-3 - Size 5" x 8"

All steel frame with plywood bed. Load capacity 500 lb. Six 10" pneumatic tires. 4" railings with provision for tie downs. Strong steel tongue. Easy towing with ATV, golf cart, garden tractor or by hand. Folds for easy rolling through doorways. Stores on caster wheels for minimum storage.

\$1495



M8005 Moto Cart
Shown with Optional Add-Ons

Musser Keyboard Mover

M8005 Small keyboard cart system with wheels. Designed for M645, M646 Bells, M39 Xylophone. Designed for M63, M65, M66 and M67 Musser marching mallet instruments.

\$385

Musser Moto Cart Add-On Options

Model	Description	Sale
M8003	Trap Table w/Adapter for M8005 & M8006	\$165
M8004	Crash Cymbal Holder (fits all carts except M8008)	\$245
LM453CLU	Multi-Purpose Clamp	\$50
P3931A	Snare Basket Assembly	\$65

Musser Mallet Moto-Carts

Designed specifically for transporting mallet instruments on rough terrain. Constructed of 2" tubular steel with steel cross bars and 5" heavy duty casters. Cart adapts to all Musser concert fixed frame instruments. Easily breaks down into four small components for easy transporting.

Model	Description	Sale
M7001	fits M31 Marimba	\$685
M7002	fits M42 & M61 Marimba/Xylophone	\$695
M7003	fits M44 Vibe	\$675
M7004	fits M51 Xylophone	\$685
M7005	fits M55, M55G, M46 Vibraphones	\$675
M7006	fits M645 and M646 Bells	\$615
M7007	fits M360 and M300 Marimba	\$855



Jarvis Movers & Moto-Carts Excluded from FREE Shipping Offer

Jarvis & Musser Movers & Carts
Factory Order - Allow 2-4 Weeks

Adams, DSI & Jarvis Products
Factory Order
Allow 2-4 Weeks

JARVIS



Adams Mallet Percussion Endurance Field Frames

Specifically designed with the demands of outdoor performance. Extra large locking precision wheels. Sturdy oversized tube construction. Easily navigates rough, uneven outdoor terrain and perfectly suited for indoor concert events. Features Adams height adjustment system. Accessory bar allows you to add drums, bells, cymbals, and percussion accessories.

Model	Description	List	Sale
FFXS	Soloist Xylophone Frame; specify 3.5 or 4 octave	\$1482	\$995
FFXC	Concert Xylophone Frame; 4 octave	\$1482	\$995
FFGC	Concert Glockenspiel/Bells Frame	\$1595	\$1065
FFMS	Soloist Marimba Frame; specify 4 or 4.3 octave	\$1690	\$1135
FFMC	Concert Marimba Frame: 4.3 octave	\$1690	\$1135
FFMA	Artist Marimba Frame; 4.3 octave	\$1690	\$1135
FFVC	Concert Vibraphone Frame; 3 octave	\$1690	\$1135

Adams, DSI & Jarvis Products
Excluded from
FREE Shipping Offer

Adams Field Frame Attachments

Model	Description	List	Sale
PTT1215MP	Trap Table 12" x 15"	\$219	\$115
PTT1523MP	Trap Table 15" x 23"	\$229	\$125
CH-1030	Boom Cymbal Holder 7/8" Post with stop lock	\$149	\$95
CH-830	Cymbal Holder w/Quick Release	\$69	\$42
PCX-100	Pipe Clamp w/Adjustable Jaw	\$49	\$29
PCX-200	Pipe Clamp w/Tilting Clamp	\$55	\$32
ADP-20	Multi-Clamp w/Quick Release	\$49	\$29

Discontinued Adams Attachments

* Limited Stock *

Model	Description	List	Sale
CH-70	Cymbal Holder w/Quick Release	\$69	\$29
AX-20	Multi-Clamp w/Quick Release	\$49	\$19



Jarvis Uniform Mover

1317-1 Uniform Mover holds 48 uniforms 60" tall, 28" wide and 96" long. 5" Rubber wheels. Each uniforms stays securely in place with notches in the hanger bar.

\$795

1310-12-3 Optional Spring Loaded hold down bar **\$325**

Jarvis Combination Uniform & Hat Mover

1310-1 Super strong, sturdy built of knock-down construction for easy shipping. Holds 48 uniforms. 24 Uniforms hang neatly each side. Uniforms stay securely in place with notches in the hanger bars. Holds 48 boxed hats. Box sizes up to 12" wide, 12" deep, 8" or 10" high. Also, holds plastic shako boxes up to 10" tall. Dimensions: 8' long, 24" deep, 77" high. 5" Rubber wheels.

\$1250



DSI Plume Cases & Carts

Durable denier nylon bag with heavyweight, fiberboard tubes. Zipper closures on both sides for easy access. Over the shoulder carrying strap.

Model	Description	Plume Length	Sale
HAPC10513C	105 Piece Plume Case w/Cart	13.75"	\$123.45
HAPC06313	63 Piece Plume Case only	13.75"	\$66.25
HAPC06315	63 Piece Plume Case only	15"	\$81.00
HAPC06318	63 Piece Plume Case only	18"	\$89.95
HAPC06320C	63 Piece Plume Case w/Cart	20"	\$111.35
HAPCTC	Plume Case Cart	--	\$26.95

Director's Showcase Podiums

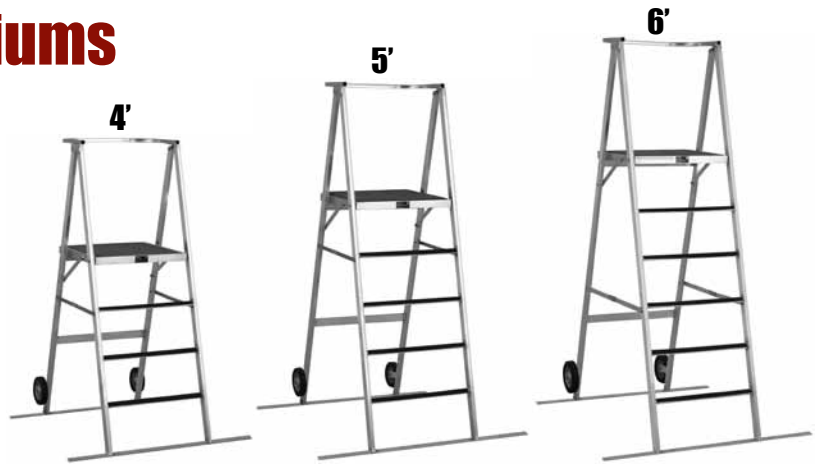

42" & 52" Command Center Podiums

Newly designed making it a snap to get on & off the field in record time!

Features Include:

- Platform Size: 38" x 36"
- Less weight
- New all-weather traction platform
- Easy-on & off boundary rails
- Wider steps
- Removable hand & back boundary rails
- Maneuvers easy on field



Podiums Excluded from FREE Shipping Offer

Factory Order Allow 2-4 Weeks

Space Saver Ladder Podiums

Space saver podiums conserve valuable space in your band room and added relief for your school budgets.

Features Include:

- Platform Size: 24" x 27"
- Wide, anti-slip steps
- Roomy platform size
- Simple & easy set up & tear down
- Boundary rail
- (2) 7" heavy duty transport wheels
- Lightweight yet sturdy aluminum structure

Model	Description	Sale
PD42	42" Silver	\$710
PD42B	42" Black	\$850
PD52	52" Silver	\$819
PD52B	52" Black	\$950

Model	Description	Sale
PD48L	4' Silver	\$646
PD48LB	4' Black	\$725
PD60L	5' Silver	\$685
PD60LB	5' Black	\$772
PD72L	6' Silver	\$731
PD72LB	6' Black	\$822

6' Command Center Podium

100% weather proof and can be left out on the marching field all season with confidence.

Features Include:

- Large Platform Size: 4' x 6'
- Nonskid, Heavy duty aluminum deck
- Ladders on 2 sides for easy access
- Removable front & back boundary rails
- Maneuvers on field in "up" position by pulling only
- Includes (2) 8" pneumatic tires
- Collapsible for easy transport & storage

Model	Description	Sale
PD70	Silver	\$1763
PD70B	Black	\$1993
Options:		
PDACCTPS Collapsible Towing Package; Silver		\$198
PDACPDWS Transport Package Silver w/4 heavy duty 10" pneumatic tires (2 swivel w/brakes, 2 stationary)		\$496



Shown with PDACCTPS Towing Package



Shown with PDACPDWS Transport Package

Jarvis Drum Major Podiums

Constructed of lightweight aluminum for easy transport, setup & take down. Made from 5 custom aluminum extrusions these podiums provide maximum quality and durability. Steps & platform have raised ribs and are lined with non-skid tape to prevent slipping.

Model	Height	Platform Size	Sale
1095-2 (9)	24"	24" x 24" <i>railing additional</i>	\$395
1093-2 (7)	42"	28" x 28" <i>railing additional</i>	\$695
1094-2 (8)	52"	28" x 28" <i>railing additional</i>	\$725
1096-2 (10)	52"	36" x 32" <i>railing additional</i>	\$875
1200-2 (12)	62"	36" x 32" <i>railing additional</i>	\$950
1400-2 (14)	72"	36" x 32" <i>includes railing</i>	\$1150
1500-2 (15)	6'	44" x 72" <i>Scissor Lift w/Railing</i>	\$2995
1173	---	Podium Railing (<i>Specify Model</i>)	\$195

**Jarvis Products
Excluded from
FREE Shipping Offer**

**Factory Order
Allow 2-4 Weeks**

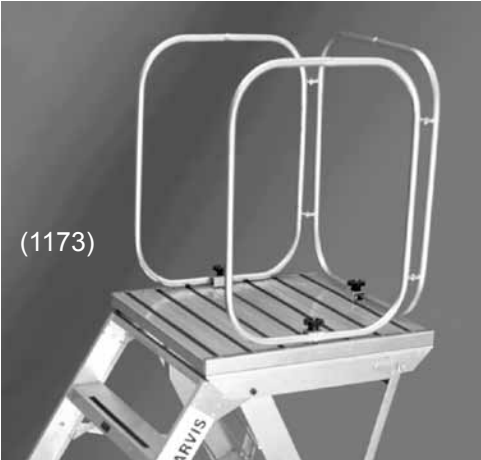
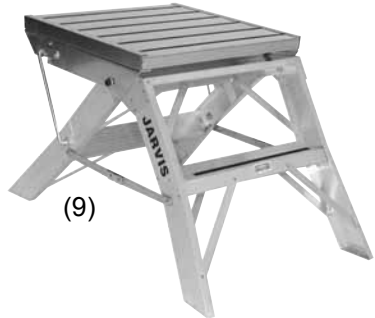
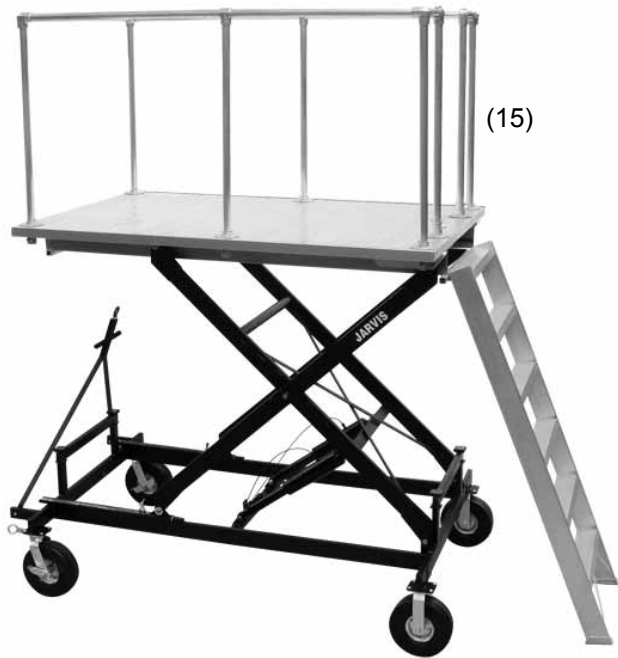



Taylor Drum Tension Rods

TR4 Replacement 4" Drum Tension Rods.
Set of 12.

\$12 Set



Pearl Sound Projectors

Attaches to bottom via hook & loop fastener. Pearl Logo.

Model	Description	Sale
SP-2	13" White	\$27
SP-2B	13" Black	\$27
SP-1	14" White	\$29
SP-1B	14" Black	\$29



Yamaha Bass Drum Rim Saver

Pair. Protects rims from future shot damage. Enhances rimshot sounds. Easy installation.

RS1418 fits 14" & 18" Bass Drums
RS2032 fits 20" to 32" Bass Drums **\$28**



Taylor Wire Snare Strainer

14-25WS

\$12

14" Wire Snare strainer
25 Strand

15-20WS

\$15

15" Wire Snare strainer
20 Strand

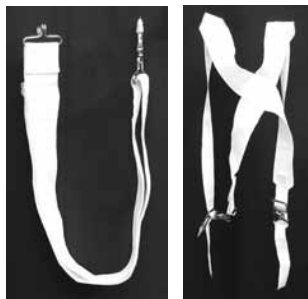

Taylor Snare & Bass Drum Sling

White, wide webbing with adjustable straps.
Heavy duty metal buckle clips.

3312 Snare **\$15**

3314 Bass **\$25**



Yamaha Sound Projectors

Easy velcro attachment. Yamaha Logo.
Specify Standard or Square Cut Projector.

\$30

Model	Description
MSP13	13" Transparent w/White Logo
MSP13B	13" Black w/White Logo
MSP13W	13" White w/Black Logo
MSP14	14" Transparent w/White Logo
MSP14B	14" Black w/White Logo
MSP14W	14" White w/Black Logo



Pearl Bass Drum Rim Shooter

BDR-1 Clamp on hoop protector.

\$18



Pearl Bass Mallet Holder

BMH100 Bass mallet holder with built-in rim shooters.

\$55



Ludwig Snare & Bass Drum Sling

Black, wide webbing. Adjustable straps.
Metal buckle clips.

LF382B Snare **\$20**

LF350B Bass **\$30**



(Exclusions are noted)



Taylor Angle Reduction Bar

100ARB Metal angle reduction bar used to attach marching carrier to drum.

\$15



Pearl Bass Drum Hoops
Wood Black Matte Finish

Pearl & Yamaha Hoops
Factory Order Allow 2-4 Weeks

Yamaha Bass Drum Hoops
8200 Series
Black finish Wood hoops

Competitor Series 1.5" Wide

Model	Size	Sale
RIM-16CB	16"	\$55
RIM-18CB	18"	\$60
RIM-20CB	20"	\$65
RIM-22CB	22"	\$70
RIM-24CB	24"	\$75
RIM-26CB	26"	\$85
RIM-28CB	28"	\$95

Championship Series 2" Wide

Model	Size	Sale
RIM-16PB	16"	\$60
RIM-18PB	18"	\$65
RIM-20PB	20"	\$70
RIM-22PB	22"	\$75
RIM-24PB	24"	\$85
RIM-26PB	26"	\$95
RIM-28PB	28"	\$110
RIM-30PB	30"	\$125

Model	Size	Sale
U0074513	16"	\$115
U0074523	18"	\$115
U0074533	20"	\$130
U0074543	22"	\$130
U0074553	24"	\$150
U0074563	26"	\$150
U0074573	28"	\$165
U0074583	30"	\$185



(Exclusions are noted)

Taylor Drum Tuning Keys

415 Regular T-Style
Nickel Plated

\$2 Each / \$18 Dozen



420TK Speed Style
Nickel plated drum key for fast tightening or release of lugs.



\$5 Each / \$22 Set of 6

430 Torque Style
Ratchet action for quick replacement of drum heads. Screwdriver attachment makes it easy to deal with minor emergencies; tightening loose lugs, adjust or replace snares, etc. Phillips screwdriver head & 3 position ratchet selector switch.



Rhythm Tech ProTorq Drum Key

RT7350 Combination torque wrench & drum key. Allows players to preselect a tension level for tuning any drum, giving them a super fast way to tune. By using a thumbwheel with numeric settings, drummers quickly & accurately tune all of their drum lugs without undertightening or overtightening. Alerts a drummer when a lug has been sufficiently tightened.

\$25

Ludwig Timpani Tuning Key

P15011 Ludwig Timpani tuning key is heavy duty and specially designed to fit all makes of Ludwig timpani. Thick metal frame is chrome plated.



\$28

Ludwig Torque Wrench Key

L111 Perfect solution for your tuning needs from standard to ultra high tension.



\$16



Yamaha Drum Tuning Keys

DK15 Standard T-Style \$6
DK30 Power Drum T-Style \$18
TK40 Timpani Tuning Key \$10



**Ludwig Planet Exactone
Timpani Tuning Gauge**

Professional tuning gauge. LKP Models are designed for Grand Symphonic, Professional and Standard 20, 23, & 32" Models. LKPS Models designed for Standard 26" and 29" Timpani only. List \$445

\$275

Options:

- LKP20 fits 20" bowl
- LKP23 fits 23" bowl
- LKP26 fits 26" bowl
- LKP26S fits 26" Standard bowl
- LKP29 fits 29" bowl
- LKP29S fits 29" Standard bowl
- LKP32 fits 32" bowl



**Ludwig Professional
Timpani Tuning Gauge**

Pedal Activated Professional Model
List \$405

\$255

Options:

- LKG20 fits 20" bowl
- LKG23 fits 23" bowl
- LKG26 fits 26" bowl
- LKG29 fits 29" bowl
- LKG32 fits 32" bowl



**Ludwig Standard
Timpani Tuning Gauge**

Hoop Activated Standard Model
List \$285

\$175

Options:

- LKH20 fits 20" bowl
- LKH23 fits 23" bowl
- LKH26 fits 26" bowl
- LKH29 fits 29" bowl
- LKH32 fits 32" bowl

Factory Order
Allow 2-4 Weeks



**Ludwig Shallow Drop
Timpani Covers**

Light Vinyl Dust Covers

- L196 fits 20" bowls **\$70**
- L197 fits 23" bowls **\$70**
- L198 fits 26" bowls **\$75**
- L199 fits 29" bowls **\$75**
- L200 fits 32" bowls **\$75**

FREE SHIPPING
U.S. Contiguous
**ON ACCESSORY
ORDERS OVER
\$75**
(Exclusions are noted)

Ludwig[®]



Ludwig Full Drop Timpani Covers

Light Vinyl Dust Covers

- L144 fits 20" bowls **\$75**
- L145 fits 23" bowls **\$75**
- L131 fits 26" bowls **\$80**
- L135 fits 29" bowls **\$80**
- L147 fits 32" bowls **\$80**

Lined Vinyl Dust Covers

- L220TP fits 20" bowls **\$85**
- L223TP fits 23" bowls **\$95**
- L226TP fits 26" bowls **\$100**
- L229TP fits 29" bowls **\$100**
- L232TP fits 32" bowls **\$100**

Padded Pro Dust Covers

- L120TP fits 20" bowls **\$145**
- L123TP fits 23" bowls **\$145**
- L126TP fits 26" bowls **\$155**
- L129TP fits 29" bowls **\$155**
- L132TP fits 32" bowls **\$155**



Universal 51 Piccolo Case

USA Series built by MTS in Elkhart, IN. Scuff resistant black plastic shell, plush interior. Fits all piccolos. Inside dimensions: 8.5" Body, 5" Head. List \$43

\$20



Universal 42 Flute Case

USA Series built by MTS in Elkhart, IN. Hard scuff resistant black plastic shell, plush interior. Fits all flutes with range to low C or low B. List \$4462
Specify Low C or Low B when ordering.

42C Low C
42B Low B

\$30

Universal 7300 Flute Backpack Case

Lightweight (1.5 lbs). Durable softshell case distributed by Conn-Selmer. Offers maximum protection. Interior fits all flutes with range to low C only. Black plush interior with 2 extra small slotted storage areas the size of the main flute body. Zipper closure, 2 carrying handles. Detachable backpack straps. Single backpack strap may also be used for shoulder strap. Small side pouch for miscellaneous storage with zipper closure. List \$51
**Does not hold flute cases.*



\$15

Color Options:

7300BK Black 7300R Red

Universal 70 Oboe Case

USA Series built by MTS in Elkhart, IN. Hard injection molded plastic shell, extremely durable. Heavy duty latches, two-piece handle. Plush interior. Fits all oboes. List \$69

\$35



Universal 858 Oboe Case

USA Series built by MTS in Elkhart, IN. Hard shell plastic case covered with black cloth. French styling, rounded corners, Black plush interior. Universal design to fit all models. Nickel plated latches. Outside dimensions: 3" wide, 8" high, 14" long. List \$130

\$55



Cases Excluded from FREE Shipping Offer

Universal 8 Bb Clarinet Case

USA Series built by MTS in Elkhart, IN. Hard injection molded plastic shell, extremely durable. Heavy duty latches, two-piece handle. Plush interior. Fits all Bb clarinets. List \$69

\$35



Leblanc CP7200 Bb Clarinet Case

Durable black plastic shell case. Rubber ribs and feet; resists slipping on smooth surfaces. Side positioned heavy duty latches. Large handle, removable shoulder strap. Piano hinge lid. Black interior. Designed to fit all Bb models. List \$79

\$40



Universal 862 Bb Clarinet Case

USA Series built by MTS in Elkhart, IN. Buffet Style, Black hard shell plastic case covered with black cloth. French styling, rounded corners, black plush interior. Nickel plated latches. Designed to fit all Bb models. Outside dimensions: 3" wide, 8" high, 14" long. List \$130

\$55



Universal 7159 Carry-All Bb Clarinet Case

Wood shell construction, black vinyl covering. Separate music book compartment in lid. Reinforced stitched seams, metal corner brackets. Black plush interior. Designed to fit all Bb clarinets. Dimensions: 4.5" wide, 10.5" high, 14.5" long. List \$138

\$55



Leblanc CSBAM Bb Clarinet Case

Previously distributed by Conn-Selmer. Used with their Professional models. Sleek lightweight (2.5 lbs) black molded plastic shell. Zipper closure with Cherry Red zipper tabs. Easy grip corners allow case to be picked up and used as a temporary carrying handle. Detachable shoulder strap with BAM stitched on webbing. Soft sponge insert fits any Bb Clarinet. List \$145

\$75



***** Limited Stock *****

Universal C40EF Eb Clarinet Case

New! Wood shell construction. Black vinyl covering. Nickel hardware. Black plush interior. Built for Vito Eb Clarinet, however, the internal section compartments are universal. Will fit all makes with comparable lengths as listed. Fits Vito, Bundy, Noblet and many more. List \$670

Dimensions:

Body length: 13 1/4"

Barrel Length: 1 5/8"

Bell Length: 3 1/8"

Outside Dimensions: 4" x 6" x 15.5"

\$95

Leblanc 7860 Bliss Bb Clarinet Case

Lightweight (1.9 lbs) Softshell case with zipper closure. Durable construction. Black cloth covering with black plush internal lining. Designed to fit all Bb clarinets. Side zippered compartment holds phone, calculator, pens, etc. Side webbing holds a water bottle. Matching cloth handle on top side. Back pack straps with reflector strips on straps and front side of case. List \$68.25

\$20

HOT BUY



Buy 5 Get 6th FREE!



Universal 146AL Alto Clarinet Case

Wood shell construction, black vinyl covering. Metal corner and side brackets. Plush interior. Heavy duty nickel plated latches. Designed to fit all one piece models. List \$135

\$95



Universal 43D Bass Clarinet Case

Wood shell construction, reinforced vinyl stitched seams. Black vinyl covering, metal corner brackets. Plush interior, heavy duty nickel plated latches. Designed to fit all one-piece models w/low Eb key on body (no bell key). Body Length: 35 3/8". List \$211

\$125



Universal 6006 Bass Clarinet Case

Wood shell construction, black vinyl covering. Metal corner and side brackets. Plush interior, heavy duty nickel plated latches. Designed to fit all one piece models w/low Eb key on bell. Body Length: 34". List \$211

\$125

Taylor 1440 Contra Alto Clarinet Case

Wood shell construction, reinforced vinyl stitched seams, black vinyl covering, metal corner brackets, plush interior, heavy duty nickel plated latches.

Outside Dimensions:

6.75" wide, 9.75" high, 52.25" long

****Designed to fit Selmer Bundy 1440 Only**

List \$409

\$295



**Cases Excluded from
FREE Shipping Offer**



Selmer Bundy 4848 Bass Clarinet Case

No logo on case. Wood Shell construction. Black vinyl covering, reinforced stitched seams. Nickel plated hardware. Soft sponge body compartment fits all one piece bodies with 34" maximum length.

List \$259

Fits: Selmer/Bundy 1430, Vito 7166

other Models with Low Eb key on Bell

*Does not fit bass clarinets with low Eb key on body or models with extended range to low C.

\$125



Universal 129 Bassoon Case

Wood shell construction, black vinyl covering. Reinforced vinyl stitched seams, metal corner brackets. Plush interior. Nickel plated hardware. Designed to fit all models. Dimensions: 4.5" wide, 11.25" high, 27" long. List \$220

\$125

**Cases are new, however, have
minor nicks and scuffs from
storage and handling.**



Universal 7601 Lightweight Alto Sax Case

Lightweight (5 lb, 6 oz) Soft Shell case with black canvas cover. Zipper closure with center velcro tab. Adjustable detachable shoulder strap. Designed to fit all models. Large side compartment (1' x 10" x 18") with zipper closure for book storage. Internal storage compartment with lid for neck and accessory storage. Double strap handles with wrap around padded closure. Outside Dimensions: 7" wide, 11.5" high, 25" long. List \$162

\$45



Universal 1304 Alto Sax Case

Wood shell construction, black vinyl covering. Reinforced vinyl stitched seams. Antique brass hardware, metal corner brackets. Plush interior. Heavy duty hardware. Designed to fit all models. Dimensions: 6.5" wide, 11" high, 25" long. List \$205

\$95



Selmer 4862 Vanguard Alto Sax Case

Sturdy wood shell construction with black vinyl covering. Corners are reinforced with stitched trim. Brass hardware. Soft sponge insert fits Selmer Series II, III, VI, VII and most alto saxes with bell keys on player's right side. Outside dimensions: 6.5" wide, 11" high, 25" long. List \$300

\$125

HOT BUY



Conn-Selmer 50745 Tenor Sax Case

Imported by Conn-Selmer for student models. No logo on case. Lightweight (8 lbs). Durable plastic shell, heavy duty with gold aluminum valance and latches. Black plush interior. Detachable shoulder strap. Separate compartment for neck. Large internal compartment for accessories. Interior nesting is designed to hold older and newer models with bell keys on either side. List \$297

***Universal Fit! We have not found a tenor sax that does not fit into this case!** **\$95**

Buy 3 Get 4th FREE!



Universal 1215 Bari Sax Case

USA Series built by MTS in Elkhart, IN. Heavy duty plastic with recessed wheels. Durable case for maximum protection. Black plush interior with universal padding to fit all Low A and Bb models. Heavy duty nickel plated hardware. Full length back piano hinge. Extra end carrying handle. Large accessory compartment with lid. 18.5 lbs.

Dimensions: 9.5" x 16.75" x 44" **\$245**
List \$665



Universal 510-VN Violin Case

USA Series built by MTS in Elkhart, IN. Lightweight vinyl shell with aluminum valance. Nickel hardware. Plush interior. Formed insert fits all 1/2, 3/4, 4/4 size models. List \$113

Models:
510-1/2 **\$55**
510-3/4
510-4/4



Universal 1305 Tenor Sax Case

Wood shell construction, black vinyl covering. Reinforced vinyl stitched seams. Antique brass hardware, metal corner brackets. Plush interior. Heavy duty hardware. Designed to fit all models. Dimensions: 7.5" wide, 13" high, 33" long. List \$244

\$115



Leblanc C7190BA Bari Sax Case

Fits newer style bari saxophones with Low A key. Wood shell construction. Black plush interior. Black vinyl covering, reinforced vinyl stitched seams. Nickel plated hardware with 4 closure latches. 14.5 lbs. **Dimensions:** 8.5" x 15" x 42"
List \$499

\$175

Only Fits:

Couf
Jupiter 593, 893, 993
Leblanc Vito 7190BA
Selmer BS500, 55AF
Yamaha YBS52, YBS61, YBS62
Yanagisawa B901, B902, B991, B992

Does NOT Fit: Any low Bb Model
Conn 11M King Signet 156A



Selmer 9006 BAM Soprano Sax Case

Universal Style fits soprano saxes with Detachable Necks only. Lightweight (5 lbs) soft shell case. Black covering. Soft internal padding with plush covering. Three nesting spots for mouthpiece, straight neck & curved neck. Nice sized additional compartment for reeds, etc. Zipper closure w/2 additional snap closures allow you to bypass zipper yet securely holds lid closed. Includes 2 Case Handles (top & side), Detachable Shoulder strap & Backpack Straps. Grey zippered side accessory compartment. List \$435

Inside Dimensions: Max Body Length: 23"

Outside Dimensions: 5.5" x 9" x 25.5"

\$175



Universal 142 Bari Sax Case

Wood shell construction, black vinyl covering. Heavy duty nickel plated hardware. Designed to fit all makes (low A & standard). Inside storage compartment. List \$450

\$245

**Cases Excluded from
FREE Shipping Offer**



Universal Viola Case

USA Series built by MTS in Elkhart, IN. Lightweight vinyl shell with aluminum valance. Nickel hardware. Plush interior. List \$113-\$157

Models:
510-13 fits 13" Viola **\$55**
510-14 fits 14" Viola
511-15 (15.5) fits 15", 15.5" Viola **\$75**
511-16 (16.5) fits 16", 16.5" Viola

**Cases are new, however, have
minor nicks and scuffs from
storage and handling.**



Universal 7160 Cornet Case

Wood shell construction, black vinyl covering. Nickel hardware. Reinforced vinyl stitched seams. Metal corner brackets. Black plush interior. Designed to fit all standard models. Does not fit cornets with Shepherd's crook. List \$141

Inside Dimensions:

Bell Rim to Back Crook: 16.5"
1st Valve Casing to Back Crook: 5"

Outside Dimensions:

6.25" x 10.5" x 18"

\$65



Universal 7161 Trumpet Case

Wood shell construction with black vinyl covering. Reinforced vinyl stitched seams. Nickel hardware, metal corner brackets. Lightweight. Universal interior design fits all standard model trumpets. List \$152

Inside Dimensions:

Bell Rim to Back Crook: 19.5"
3rd Valve Casing to Back Crook: 8.5"
1st Valve Casing to Back Crook: 5"

Outside Dimensions:

6" x 11" x 21.5"

\$75



Bach C180 Strad Trumpet Case

Bach Professional design. Wood shell construction with dark covering. Corners reinforced with stitched alligator style trim. Matching handles (Additional side carrying handle). Brass hardware with locking latches. Grey plush interior. Large accessory compartment for mutes. Small accessory compartment with snap shut lid for mouthpieces and oils. Weighs 9.25 lbs. List \$377

Outside Dimensions:

8" wide, 9" high, 21" long

\$225

HOT BUY



Bach 1843 Trumpet Case ***

Professional case with Bach logo stitched in gold. Wood shell construction with brown fabric covering. Brown plush interior with dust flap cover. Additional side carrying handle. Zipper closure. Side storage compartment for books. List \$261

*Fits most Bb and C Models. ****

Inside Dimensions:

Bell Rim to Back Crook: 18.5" to 19.5" Maximum
Bell Rim to Mouthpipe End: 19.75" Maximum

Outside Dimensions: 6.5" wide, 12" high, 22" long

\$125

*** Bach TR300/TR300H2 Models have a 19.75" dimension from bell rim to back crook. The memory foam with compression on both ends will allow this to fit with proper insertion.



Blessing C153 Flugelhorn Case

Wood shell construction, black vinyl covering, reinforced stitched seams. Plush interior, nickel plated hardware. Metal corner brackets. Additional side carrying handle. Fits Blessing B153, B154, B155, XL-FL Flugels. Soft sponge insert is easily removed. Plush lining can be peeled back to allow trimming for customized fitting. See inside dimensions for other models.

\$95

Inside dimensions:

Max Bell: 6.5",
Max Length: 19", Max Width: 11"

Outside Dimensions:

7.75" wide, 12" high, 21" long

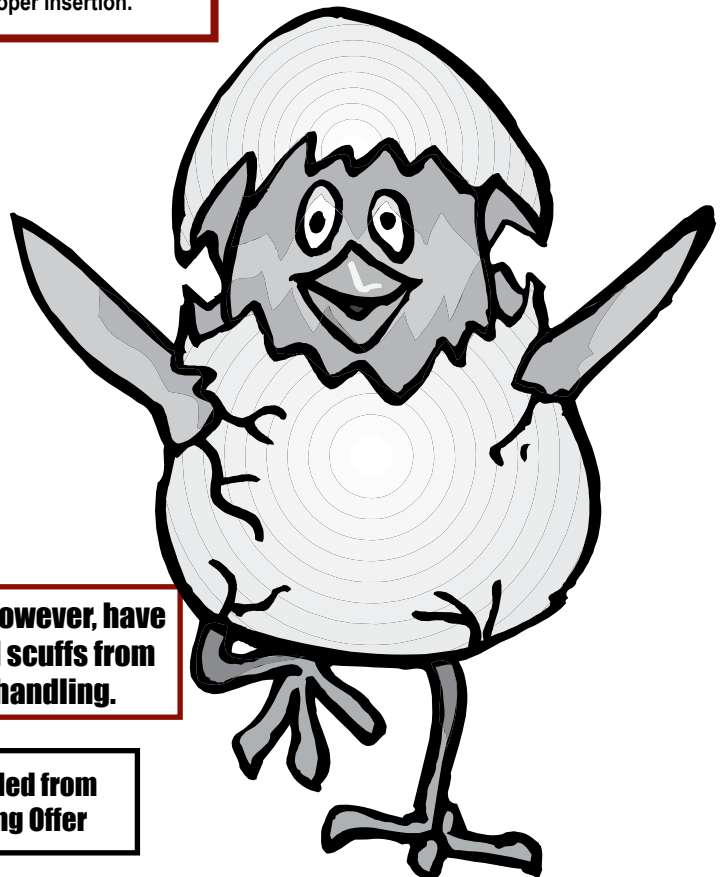

Cases are new, however, have minor nicks and scuffs from storage and handling.

Cases Excluded from FREE Shipping Offer



HOT BUY



Bach 1867LIB Trombone Case

Professional Tenor/F-Attachment Trombone Case. Bach logo and Liberty stitched in White. Wood shell construction with black fabric covering. Zipper closure. Black plush interior. Additional side carrying handle. Zipper closure on side storage compartment for books. Fits most tenor & F-attachment trombones with max 8.5" bell. List \$371

\$95

CASES Fit Models:

Bach 36B, 36BO, 42B, 42BO, TB200B
Blessing B78, B88, B88O
Conn 50H, 52H, 88H, 88HO
King 3B, 605F, 607F, 608F, 609F
Yamaha YSL Series

***Does not fit King 5B Trombones. If you have a King 4B we can enlarge the insert to fit. Call to request adjustment when ordering.*

Bach CTR142 F-Attachment Trombone Case

Professional Model F-Attachment Trombone case. Wood shell construction. Black vinyl covering with reinforced stitched end seams. Black plush interior. Fits most Tenor and F-Attachment trombone with maximum bell diameter up to 8.5" (standard wrap or open wrap models). List \$429

\$145



Universal 34 Trombone Case

USA Series built by MTS in Elkhart, IN. Scuff resistant plastic shell with plush lining. Nickel hardware. Designed to fit most tenor trombone models with maximum bell diameter of 8". Includes accessory compartment. List \$205

\$95



Pro Tec PB309CT Bass Trombone Case

Universal Contoured style fits bell sizes up to 10.5", open/standard wrap. Roomy exterior pocket for music and accessories. Lightweight frame with maximum protection. Heavy duty zipper. Black exterior, soft velveta lining to protect the instrument finish. 1000 denier water repellent. List \$319

\$255

Cases Excluded from FREE Shipping Offer

Cases are new, however, have minor nicks and scuffs from storage and handling.



***** Limited Stock *****

Eastman 320BN Lightweight Softshell French Horn Case

Durable softshell offers maximum protection yet weighs only 6.75 lbs. Universal design fits all makes of single and double horns. Light brown exterior cover. Zipper closure. Double handle straps for easy carrying. Detachable shoulder strap. Small side zippered exterior compartment for accessories. Small internal compartment with lid for oils.

\$95



Universal 1135 Single French Horn Case

Lightweight black scuff resistant molded shell with wide aluminum valance, black plush interior, universal interior design fits all single horn models, nickel plated hardware. List \$210

\$105



Universal 125A Single/Double French Horn Case

USA Series built by MTS in Elkhart, IN. Scuff resistant molded shell with wide aluminum valance. Black finish. Interior design fits all models. Heavy duty latches. List \$371

\$155

*** Limited Stock ***



Blessing C200 Marching Trombone Case

Wood shell construction, black vinyl covering, reinforced stitched seams. Plush interior, nickel plated hardware. Metal corner brackets. Fits Blessing M200, Bach 883 & Olds Marching Trombones with 8" bell.

\$115

Outside Dimensions:

11.5" wide, 10.5" high, 18.5" long



Taylor 1201 Upright Baritone Case

USA Series built by MTS in Elkhart, IN. Durable lightweight (13 lbs) plastic shell. Aluminum valance, heavy duty draw latches, plush interior. Universal design holds upright bell models with upright valves. 11.5" max bell diameter, 27" max length. List \$530

Fits:

Besson 762, 765
King 2280
Eastman EEP321, EEP421, EEP426
Yamaha YEP201, YEP321

\$205



Universal 6003 Marching Horn Case

Wood shell construction, black vinyl covering. Nickel plated hardware. Metal corner brackets. List \$215

#6003MB Marching Baritones

#6003MFH Marching French Horns

#6003MM Marching Mellophones

#6003MT Marching Trombones (King)

\$135

Please provide the following when ordering:

A. Make & Model

B. Bell Diameter

C. Length from Bell to Back Crook

(Blocks will be positioned for proper fit)



Universal 143

Bell Front Baritone Case

Wood shell construction. 3/8" thick perimeter adds the strength and durability that traditional cases lack. Black vinyl covering, black plush interior. Heavy duty nickel hardware. Designed to fit all bell front models. Weighs 14.7 lbs.

Please provide the following:

A. Make & Model (Blocks positioned for proper fit)

B. Length from top bow to bottom bow

\$165

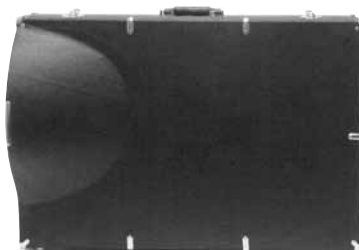

Universal 143A Upright Bell Baritone Case

Wood shell construction, formed style. Black vinyl covering. Heavy duty nickel hardware. Plush interior. Weighs 14.7 lbs. Cases are customized to fit your particular instrument. List \$310

\$165

Please provide the following when ordering:

A. Make & Model

B. Bell Diameter

C. Which side is bell on when being played?

D. Valve Action: Upright or Front

E. Length: Bell rim to bottom of bow

HOT BUY



Taylor 319 Lightweight Softshell Euphonium Case

Durable softshell offers maximum protection yet weighs only 14.25 lbs. Black exterior cover. Zipper closure. Double handle straps for easy carrying. End handle allows case to be pulled on heavy duty wheels. Detachable back pack straps allow for over the shoulder option. Large zipper side compartment (9" x 12") will hold books and accessories.

Soft sponge insert

holds only these upright models:

Besson 762, 765

Eastman EEP321, EEP421, EEP426

Yamaha YEP201, YEP321

\$55

Cases Excluded from FREE Shipping Offer

Cases are new, however, have minor nicks and scuffs from storage and handling.

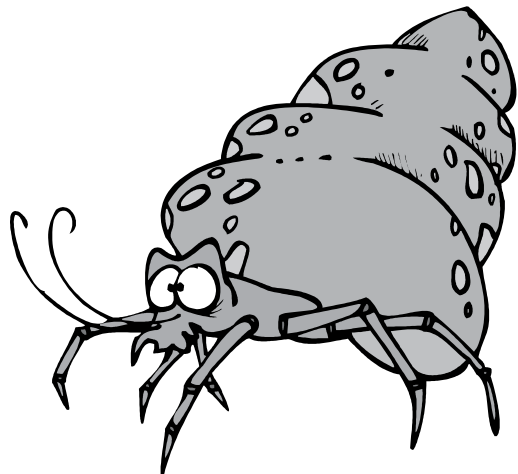



Universal 1199 Sousaphone Case

USA Series built by MTS in Elkhart, IN. Fits all sousaphones. Universal Design. Durable lightweight black plastic shell. Aluminum valance with heavy duty latches. 2 handles. Internal gray sponge padding protects horn. Recessed wheels. List \$903

\$325

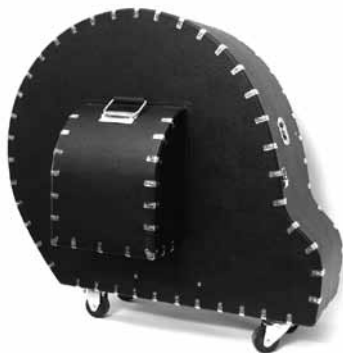

***** Limited Stock - only 3 Left *****

Universal Brute Sousaphone Case

Extremely Heavy Duty Universal case designed to fit all sousaphones. Wood shell construction covered with black vinyl. Spring loaded handle, 3 recessed butterfly latches. 4 - 3" heavy duty casters (2 are directional), angle supports every 3", extra metal corner supports around outside of case. 5 hinges on bottom. Properly padded plush interior. List \$880

\$595



***** Limited Stock *****

Eastman EEB231 3/4 Tuba Case

Demo Model. Minor nicks, scuffs and factory imperfections. Hardshell black plastic case with 4 heavy duty butterfly latches. Interior is a soft sponge covered with black plush material. 2 Handles, recessed wheels. 22.5 lbs. List \$NA

\$175

ONLY Fits these Models:

Eastman EEB231
Yamaha 104, 105
Jupiter 378

**Cases Excluded from
FREE Shipping Offer**

Please provide the following when ordering:

- A. Make & Model
 - B. Bell Diameter
- (Blocks will be positioned for proper fit)



***** Limited Stock - only 4 Left *****

Universal 139 Sousaphone Case

Universal case designed to fit all sousaphones. Wood shell construction covered with black vinyl. Heavy duty nickel plated hardware. Metal reinforced brackets around entire case. Properly padded plush interior. List \$652

\$395

Please provide the following when ordering:

- A. Make & Model
 - B. Bell Diameter
- (Blocks will be positioned for proper fit)

**HOT
BUY**



Holton 1205 3/4 Tuba Case

USA Model built by MTS in Elkhart, IN. Hard molded case. Nickel plated hardware with heavy duty latches. Plastic black padded interior. Two carrying handles. Recessed wheels. List \$685

\$245

Designed to Fit:

Eastman EEB231
Jupiter 378
Weril J370, J371
Yamaha 102, 103, 104, 105



***** Limited Stock *****

Conn 416 Tuba Case

Durable lightweight black plastic shell (20.5 lbs). Aluminum valance with 4 heavy duty latches, 2 handles. Black plush interior. Designed to fit front action models with up to 18" bell diameter. Maximum length of 34". List \$485

\$295

Fits Models:

Conn 11J,12J,15J w/18" bell
Conn 14J w/15" bell
Conn 2J,3J,4J,5J w/18" bell
King 1135 w/15" bell

**Cases are new, however, have
minor nicks and scuffs from
storage and handling.**



Taylor 135 Universal Tuba Case

Wood shell construction covered in black vinyl. Heavy duty nickel plated hardware. Reinforced brackets around entire case. Properly padded to fit your tuba. These cases are custom designed. **Specify make & model when ordering.** List \$585

\$295

Fits Models:

- Bach 869, 879
- Besson 785
- Blessing B450
- Conn 10J
- Holton BB346R
- King 1135, 1140
- Meinl Weston 10, 12
- Mirafone S186, 186-4U, 187-4U, 1270
- Olds O99, O99-4
- Reynolds TB101
- Yamaha YBB201, YBB321

Cases are new, however, have minor nicks and scuffs from storage and handling.



Taylor 136 3/4 Tuba Case

Wood shell construction covered in black vinyl. Heavy duty nickel plated hardware. Reinforced brackets around entire case. Properly padded to fit your tuba. These cases are custom designed. **Specify make & model when ordering.** List \$379-\$431

\$275

Fits Models:

- Besson 2-20, 680, 682, 683, 787, 788
- Bundy 1539
- Holton 661, 662, 663, 664
- Yamaha 102, 103, 104



Taylor 1200 Rotary Tuba Case

USA Series built by MTS in Elkhart, IN. Heavy duty plastic case. Strong durable latches. Designed to fit specific models and styles. Includes end handle and recessed wheels. List \$1190-\$1293

\$475

Fits Models:

- 1203: fits Yamaha YBB201, YBB321
- 1204: fits Miraphone 282-4U
- 1207: fits Miraphone S191, 191-4U, 1291-4U
- 1209: fits Miraphone S186, 186-4U, 187-4U and Meinl Weston 20, 25



Taylor 141 2 Piece Tuba Case

Wood shell construction covered in black vinyl. Heavy duty nickel plated hardware. Reinforced brackets around entire case. Properly padded to fit your tuba. These cases are custom designed. **Specify make & model when ordering.** List \$775-\$820

\$495

Fits Models:

- Conn 20J, 21J, 24J, 25J, 34J
- King 1240, 1241, 2340, 2341
- Olds O-98
- Reynolds TB11, TB12

Bell case holds either bell front or upright bell.

Specify bell diameter.



***** Limited Stock *****

Deg/Dynasty 225 3/4 Tuba Case

Wood shell construction covered in black vinyl. Reinforced stitched binding around sides and bottom. Nickel plated hardware. Black plush padded interior. Designed to fit specific models and styles. Includes additional end handle and 5" wheels for easy transport. **Specify make & model when ordering.** List \$650

\$225

Fits Models:

- Amati 223, 225
- Besson/Boosey Hawkes 682, 683, 787, 788
- Bundy 1539
- Holton 661R, 664
- Yamaha 102, 104

Cases Excluded from FREE Shipping Offer



***** Limited Stock *****

Deg/Dynasty 226 Tuba Case

Wood shell construction covered in black vinyl. Reinforced stitched binding around sides and bottom. Nickel plated hardware. Black plush padded interior. Designed to fit specific models and styles. Includes additional end handle and 5" wheels for easy transport. **Specify make & model when ordering.** List \$750

\$325

Fits Models:

- Besson/Boosey Hawkes 685, 789
- Bundy 1339, 1549
- Conn 12J, 15J, 2J, 3J, 4J, 5J (w/18" bell diameter)
- Couesnon
- King 1140
- Miraphone 1270



Pearl Marching Snare Case

PD1412 Fits 12 x 14 / 9 x 13 Marching Snares
 Rotationally molded for outstanding durability. Water resistant. Limited lifetime warranty. Durable straps with quick release buckle. Comfortable carrying handle. No foam.

\$95



Gator Concert Snare Case

Water resistant cases; will not warp. One piece Black Roto-Molding. Strap guides for no hassle strap replacement. Flat bottom design with extra room for mounting systems.

GP-PC1405.5SD/Black \$72.99
 Fits 5.5x14

GP-PC1406.5SD/Black \$72.99
 Fits 6.5x14



Gator Marching Snare Case

Water resistant cases; will not warp. One piece Black Roto-Molding. Strap guides for no hassle strap replacement. Flat bottom design with extra room for mounting systems.

GP-PC217/Black \$139.99
 Fits 12x14

GP-PC219/Black \$149.99
 Fits 12x14 & 12x15



Pearl Marching Tom Case

PD8004 Fits all Quad/Quint/Sextets
 Rotationally molded for outstanding durability. Water resistant. Limited lifetime warranty. Durable straps with quick release buckle. Comfortable carrying handle. No foam.

\$185



Gator Marching Tom Case

Water resistant cases; will not warp. One piece Black Roto-Molding. Strap guides for no hassle strap replacement. Flat bottom design with extra room for mounting systems. 3 top carrying handles for ease in transporting.

GP-PC234/Black \$239.99
Marching Trio

Fits all trios. Dimensions:
 24" at widest point, 45" at longest point.

GP-PC204/Black \$159.99
Marching Quad

Fits all quads. Dimensions:
 26" at widest point, 51" at longest point.



Pearl Marching Bass Drum Case

Rotationally molded for outstanding durability. Water resistant. Limited lifetime warranty. Durable straps with quick release buckle. Comfortable carrying handle. No foam.

Model	Size	Sale
PD1414	14 x 14	\$95
PD1614	14 x 16	\$105
PD1814	14 x 18	\$110
PD2014	14 x 20	\$120
PD2214	14 x 22	\$135
PD2414	14 x 24	\$145
PD2614	14 x 26	\$155
PD2814	14 x 28	\$165
PD3016	16 x 30	\$165
PD3216	16 x 32	\$170



Gator Marching Bass Drum Case

Water resistant cases; will not warp. One piece Black Roto-Molding. Strap guides for no hassle strap replacement. Flat bottom design with extra room for mounting systems. 1 Top handle, 2 Side handles for different carrying positions

Model	Size	Sale
GP-PC1614MBD/Black	14 x 16	\$79.99
GP-PC1814MBD/Black	14 x 18	\$89.99
GP-PC2014MBD/Black	14 x 20	\$114.99
GP-PC2214MBD/Black	14 x 22	\$134.99
GP-PC2414MBD/Black	14 x 24	\$154.99
GP-PC2614MBD/Black	14 x 26	\$164.99
GP-PC2814MBD/Black	14 x 28	\$169.99
GP-PC3016MBD/Black	16 x 30	\$179.99
GP-PC3216MBD/Black	16 x 32	\$184.99

Cases Excluded from FREE Shipping Offer

Cases are Ordered From Factory.
 Please Allow 2-4 Weeks for Delivery



Gator Drum Set Cases

5 Piece Set Cases.
Rotationally molded giving added strength and durability. Water resistant. Heavy duty bucket and straps with rugged comfortable carrying handles.



GP-PCFusion20 Gator Fusion Set

Includes:
20 x 16 Bass
14 x 12 Floor Tom
12 x 10 Tom
10 x 9 Tom
14 x 5.5 Snare Drum

\$379.99

GP-PCStandard Gator Standard Set

Includes:
22 x 18 Bass
16 x 16 Floor Tom
13 x 11 Tom
12 x 10 Tom
14 x 6.5 Snare Drum

\$399.99

Yamaha Marching Drum Cases

Field Master cases are constructed of high density black plastic. Includes heavy duty straps with quick release latches and sturdy hardware for maximum durability.

Model	Size	Sale
PCH-MS13 Snare	13 x 11	\$99
PCH-MS14 Snare	14 x 12	\$99
PCH-MQS Sm Quad/Quint*	8/10/12/13	\$199
PCH-MQL Lg Quad/Quint*	10/12/13/14	\$211
PCH-MB16 Bass	16 x 14	\$99
PCH-MB18 Bass	18 x 14	\$111
PCH-MB20 Bass	20 x 14	\$111
PCH-MB22 Bass	22 x 14	\$133
PCH-MB24 Bass	24 x 14	\$155
PCH-MB26 Bass*	26 x 14	\$166
PCH-MB28 Bass*	28 x 14	\$166
PCH-MB30 Bass*	30 x 16	\$177
PCH-MB32 Bass*	32 x 16	\$199

*Cases ship by Truck Freight



Pearl Marching Drum Covers

Gray durable wrap material with black trimmings and Pearl logo.



Cases Excluded from FREE Shipping Offer

Covers & Cases are Ordered From Factory.
Please Allow 2-4 Weeks for Delivery

Yamaha Marching Drum Covers

Black nylon fabric with Velcro strap attachment and Yamaha logo.

Model	Size	Sale
MDCG13	13" Snare	\$45
MDCG14	14" Snare	\$45
MDCG8023	Sm Quad (8/10/12/13)	\$62
MDCG0234	Lg Quad (10/12/13/14)	\$62
MDCG14B	14" Bass	\$45
MDCG16	16" Bass	\$50
MDCG18	18" Bass	\$50
MDCG20	20" Bass	\$55
MDCG22	22" Bass	\$55
MDCG24	24" Bass	\$60
MDCG26	26" Bass	\$62
MDCG28	28" Bass	\$62
MDCG30	30" Bass	\$65
MDCG32	32" Bass	\$65



Model	Size	Sale
SNC13	13" SFZ or MTS Snare	\$40
SNC14	14" SFZ or MTS Snare	\$40
QDC4	Marching Toms	\$60
BDC14	14" Bass	\$55
BDC16	16" Bass	\$55
BDC18	18" Bass	\$55
BDC20	20" Bass	\$55
BDC22	22" Bass	\$55
BDC24	24" Bass	\$55
BDC26	26" Bass	\$60
BDC28	28" Bass	\$60
BDC30	30" Bass	\$65
BDC32	32" Bass	\$65



Gator Drum Set Bags

5 Piece Drum Set Bags. Durable nylon construction. 10mm padded & lined interior. Comfortable carrying straps. Collapsible compact design.

GP-Standard-100 Gator Standard Set

Includes:
22 x 18 Bass
16 x 16 Floor Tom
13 x 11 Tom
12 x 10 Tom
14 x 5.5 Snare Drum

\$139.99

GP-Fusion-100 Gator Fusion Set

Includes:
22 x 18 Bass
14 x 12 Floor Tom
12 x 10 Tom
10 x 9 Tom
14 x 5.5 Snare Drum

\$139.99

Zildjian®



In Stock

Zildjian Canvas Cymbal Bag

0729 Black canvas bag. Fits cymbals up to 20" diameter. Comfortably holds 4 to 6 cymbals, foam padding, carrying strap & handles.

\$30



In Stock

Zildjian Cymbal Bag

0733 Black canvas bag. Fits cymbals up to 22" diameter. Foam padding, shoulder carrying strap.

\$48

Gator Marching Cymbal Case

Water resistant molded case; one piece molded lid & container design adds strength to corners where it is needed most; strap guides for easy strap replacement (straps are not riveted to case). 4" Deep: fits 1 pair with pads & straps or 2 pair without pads & straps.



GP-PC316/Black 16" **\$92.99**

GP-PC318/Black 18" **\$92.99**

GP-PC320/Black 20" **\$105.99**



Zildjian 1700 Cymbal Case

1700 Cymbal Safe. High impact plastic for the ultimate protection, firm rubber cushions inside, holds up to 12 cymbals with a diameter of 22".

\$80

Cases are Ordered From Factory.
Please Allow 2-4 Weeks for Delivery

**Cases Excluded from
FREE Shipping Offer**



Gator Economy Cymbal Case

GP-PC302 Meant for local travel with minimal cymbal cartage. Fits 6 to 9 cymbals, sizes up to 22".

\$79.99

Taylor Lightly Padded Cymbal Bag

Holds 2 pair (4 cymbals). Zipper closure & double handle. Additional outside zippered compartment for accessories.

CB14 14" \$20
No shoulder carrying strap

CB16 16" \$23
With shoulder carrying strap

CB22 18"- 22" \$23
With shoulder carrying strap

Set of all 3 Sizes \$60



In Stock



Taylor Marching Stick/Mallet Bags

Universal Style durable nylon fabric with light padding. Weightless & comfortable to carry. Water & stain resistant. Velcro straps allow for easy attachment to snare tension rods or marching tom frame. The easy access is great for holding spare sticks or mallets.

SB Marching Snare Single

Holds 1 pair of sticks, mallets or drum brushes. Weight 2.3 oz

\$8 Each
\$25 Set of 4



DSB Marching Snare Double

Holds 2 pair of sticks, mallets & brushes. Weight 3.9 oz

\$10 Each
\$25 Set of 3



MB Marching Tom

Holds 2 pair of mallets. Weight 2.8 oz

\$8 Each
\$25 Set of 4



OPEN

ROLLED



MP Roll Up Stick/Mallet Bag

Faux plush lambs wool interior lining. 10 interior compartments. 2 hooks for attachment to keyboard or drums. Fold & roll-up design for easy transportation. Large zippered compartment on backside for music. Includes shoulder strap and carrying handle. Weight 2.5 lbs. Dimensions when open: 37" wide, 23" high.

\$25

PS Pro Stick/Mallet

Padded bag with 5 individual interior compartments. 2 small internal pockets with zipper. Zipper closure with double carrying handles and shoulder strap. Outside compartment with Velcro closure. Attaches to drum with double snaps. Dimensions: 1" thick, 11.5" wide, 19" long.

\$25



DSM Standard Stick/Mallet Bag

Provides 3 individual inside compartments. Two hooks allow bag to mount on drum. Zipper closure with carrying handle. Two outside storage compartments (one with Velcro flap close, one with zipper close). Dimensions: 7.5 wide, 18" long.

\$10



Vic Firth Single Marching Snare Bag

MSBAG Bag attaches to marching snare drum with adjustable Velcro straps. Holds a spare pair of sticks. Provides easy access during quick stick changes. Made of water resistant nylon.

\$10

Vic Firth Drum Stick Bag

SBAG2 Holds 24 pairs of sticks & mallets. Contains 2 small accessory pockets; 4 outside pockets includes one large enough for sheet music. Features a detachable, padded shoulder strap and elastic fasteners with retractable clips for secure suspension from the floor tom. Water resistant leather-like vinyl with double stitching, heavy duty zipper.

\$50



Zildjian Drum Stick Bag

T3255 Standard bag with dual ties. Holds 6 pair. Carrying handle. Outer Velcro closure pocket.

\$12



Vic Firth Double Marching Snare Bag

MSBAG2 Bag attaches to marching snare drums or multi-tenors with adjustable Velcro straps. Holds 2 pair of sticks, brushes or mallets. Provides easy access during quick stick changes. Made of water resistant nylon.

\$16



Vic Firth Standard Drum Stick Bag

BSB Basic stick bag. Features 3 inside pockets. Holds 12 pair of sticks. Outside pocket for small accessories. Made of durable, water resistant nylon. Perfect for students.

\$18



Zildjian Session Drum Stick Bag

PSSB Made of synthetic material with appearance of premium leather. Two large outside zippered pockets for accessories. Four large inside pockets for sticks & mallets. Holds up to 24 pair. Thick carrying handles. Two clips for mounting.

\$35



The Taylor Music Beginner Program

Woodwinds

Flutes

Closed Hole Flutes

Econo Overhaul.....	\$18 a mo.
Beginner Return	\$20 a mo.

<SPECIAL> New Gemeinhardt 2SP	\$22 a mo. <small>Reg. \$25</small>
--	--

Open Hole Flutes

<SPECIAL> New Gemeinhardt 3B	\$26 a mo. <small>Reg. \$28</small>
Inline G/A, Low B	

<SPECIAL> New Gemeinhardt 3OB.....	\$26 a mo. <small>Reg. \$28</small>
Offset G/A, Low B	

Clarinets

Resonite/Plastic Body Bb Clarinets

Econo Overhaul Plastic	\$18 a mo.
Beginner Return Plastic	\$20 a mo.

<SPECIAL> New Plastic.....	\$22 a mo. <small>Reg. \$25</small>
---	--

Wood Body Bb Clarinets

Econo Overhaul Wood	\$25 a mo.
Beginner Return Wood	\$27 a mo.
New Wood Leblanc Bliss LB210	\$30 a mo.
New Wood Paris Noblet L45CA	\$32 a mo.

Harmony Clarinets

Econo Overhaul Alto Clarinet	\$25 a mo.
Econo Overhaul Bass Clarinet	\$45 a mo.
New Selmer/Leblanc Bass Clarinet.....	\$65 a mo.

Oboes

Econo Overhaul	\$35 a mo.
New Major Brand Plastic	\$55 a mo.

Saxophones

Alto Saxophones

Econo Overhaul.....	\$35 a mo.
New Major Brand.....	\$45 a mo.

Tenor Saxophones

Econo Overhaul.....	\$45 a mo.
New Major Brand.....	\$55 a mo.

Drums

Bells Only:

New 32 Note Bell Set (No Drums)	\$12 a mo.
---------------------------------------	------------

Drum Kit (No Bells):

New Drum Kit (No Bells)	\$12 a mo.
-------------------------------	------------

Drum Kit with 32 Note Bell Set:

Beginner Return Drum Kit with Bells.....	\$16 a mo.
New Drum Kit with Bells	\$20 a mo.

30 Month Purchase Contract
Return & Exchange Options
NO Interest!

Prices Effective March 31, 2015

Limited Stock Available on
Beginner Return & Econo Overhauled Instruments

Brasswinds

Cornets

Beginner Return	\$20 a mo.
New w/Shepherd's Crook Bell.....	\$25 a mo.

Trumpets

Beginner Return Blessing	\$20 a mo.
<SPECIAL> New Blessing BTR1277	\$22 a mo. <small>Reg. \$24</small>
Econo Overhaul Brass finish.....	\$20 a mo.
New Premium Brands, Brass finish.....	\$25 a mo.
New Premium Brands, Silver finish.....	\$28 a mo.

Trombones

Beginner Return Blessing	\$20 a mo.
<SPECIAL> New Blessing BTB1280	\$22 a mo. <small>Reg. \$24</small>
Econo Overhaul	\$20 a mo.
New Premium Brands	\$25 a mo.

French Horns

Econo Overhaul Single Horn.....	\$40 a mo.
New Single Horn	\$60 a mo.
New Double Holton H378 Horn	\$110 a mo.

Baritone Horns

Econo Overhaul Bell Front	\$40 a mo.
New Jupiter 468L Full Size Upright.....	\$60 a mo. <small>Reg. \$44</small>

Strings

Violins 1/4, 1/2, 3/4, 4/4
Violas 13" or 14"

Beginner Return Violin or Viola	\$18 a mo.
New Violin or Viola	\$22 a mo.
Beginner Return 15", 15.5", 16", 16.5".....	\$22 a mo.
New Viola 15" or 16" size	\$25 a mo.

Cellos 1/2, 3/4, 4/4

Beginner Return Cello.....	\$36 a mo.
New Cello	\$40 a mo.

30 PAYMENT PURCHASE CONTRACT WITH RETURN OPTION

DATE _____

PLEASE SEND ME THE _____ BEGINNER INSTRUMENT FOR \$ _____ A MONTH.
(Instrument Selected) (SD Residents Add Sales Tax)

I HAVE ENCLOSED MY FIRST PAYMENT. (Check, Money Order or Credit/Debit Card listed below.)

I AGREE TO PAY THE SAME AMOUNT EACH MONTH UP TO A TOTAL OF 30 MONTHS.

I CAN END THIS CONTRACT ANYTIME BY RETURNING THE INSTRUMENT WITH PAYMENTS UP TO DATE TO TAYLOR MUSIC. IF I DECIDE TO CANCEL AND RETURN, PAYMENTS PAID ARE NON-REFUNDABLE.

THERE ARE NO INTEREST OR FINANCE CHARGES.



**TO RETURN
SEND
DIRECTLY TO:**

**TAYLOR MUSIC
513 S. MAIN
ABERDEEN, SD
57401**

**DO NOT
RETURN
TO SCHOOL**

*** SUBJECT
TO CREDIT
APPROVAL**

Do Not Write In This Space

WE WILL COMPLETE THIS SECTION

<hr/>	1. TOTAL SALES PRICE (the total cost of your purchase on credit including your first payment)	<hr/>
(Instrument)	2. YOUR FIRST PAYMENT (down payment)	<hr/>
<hr/>	3. AMOUNT FINANCED (amount owing after first payment.)	<hr/>
(Brand)	4. TOTAL OF PAYMENTS (Total you will have paid when all payments have been made)	<hr/>
<hr/>	5. FINANCE CHARGE: There is NO FINANCE CHARGE. The total payments is the same as the single payment price.	-0-
(Model)	6. PAYMENT SCHEDULE: Each payment is the same as the first. A payment is due each month until 30 payments (including the first) have been made.	
<hr/>	7. We do not include insurance, nor do we make any insurance charge.	
(Serial Number)	8. There is a late fee of \$5.00 on payments over 30 days past due.	

*** Subject to Credit Approval:** I understand this contract application is subject to credit approval. I authorize Taylor Music, Inc. to obtain a consumer report from credit reporting agencies in considering this application and for the purpose of update, review or collection of my account. All information is private and complies with our Privacy Policy.

<input checked="" type="checkbox"/> PARENT NAME (PRINTED) _____	<input checked="" type="checkbox"/> STUDENT NAME _____
<input checked="" type="checkbox"/> PARENT SIGNATURE _____	<input checked="" type="checkbox"/> SCHOOL NAME _____
<input checked="" type="checkbox"/> SOCIAL SECURITY # _____	
<input checked="" type="checkbox"/> HOME PHONE # (____) _____	
<input checked="" type="checkbox"/> MOBILE PHONE # (____) _____	
<input checked="" type="checkbox"/> WORK PHONE # (____) _____	
<input checked="" type="checkbox"/> ADDRESS _____	
<input checked="" type="checkbox"/> CITY, STATE, ZIP _____	
<input checked="" type="checkbox"/> E-MAIL ADDRESS _____	

Different Shipping Address?

UPS DELIVERY *Street addresses only.*
UPS will not deliver to a P.O. Box.

Name _____

Street Address _____

City, State, Zip _____

Questions? 1-800-872-2263 or music@taylormusic.com

TAYLOR MUSIC, BY: _____ (Sales Representative) (2015)

FAX: 1-605-225-2051 WEB: www.taylormusic.com

FAX THIS CONTRACT WITH YOUR 1st PAYMENT ON CREDIT/DEBIT CARD. (VISA, MC, DI or AE)

I UNDERSTAND ONLY MY 1st PAYMENT WILL BE CHARGED. (UNLESS INDICATED HERE) →

CREDIT CARD # _____ EXP _____ CVV2 CODE _____
VI, MC, DI: last 3 digits on back of card
 AE: 4 digit code on front of card

NAME LISTED ON CREDIT CARD: _____

Optional









Automatic Payment Request:
 Check if Desired

____ YES Charge
 future payments to my
 credit card each month.

FREE Supplies

FREE Book

Each beginner instrument will receive a **FREE** Music Stand, Care Kit, Music Book and Supplies. (check one box)

<input type="checkbox"/>  Measures of Success	<input type="checkbox"/>  Tradition of Excellence	<input type="checkbox"/>  Band Expressions	<input type="checkbox"/>  Essential Elements 2000	<input type="checkbox"/>  Sound Innovations	<input type="checkbox"/>  Accent on Achievement	<input type="checkbox"/>  Standard of Excellence	<input type="checkbox"/>  Orchestra Expressions	<input type="checkbox"/>  Essential Elements Strings
---	---	--	---	---	--	--	---	--

Beefed Up Trade Allowances

Do you have any strays hiding in the barn?

WANTED

Used Bb Metal Sousaphones



DESCRIPTION

We need Sousaphones to Overhaul this winter for next years' marching season.

We will arrange pick up and pay all shipping charges for groups of 3 or more sousaphones.

Sousaphones must be complete and overhauled.

Price adjustment will be made on damaged or very poor quality models. (Damaged Bell Flares, Holes, Busted Braces, etc.)

REWARD

- | | | |
|---------------|---------------------|---------------------|
| \$1250 | • \$750 Each | • \$400 Each |
| for BRASS | • for BRASS | • for Buescher |
| Conn 20K | • Conn 14K or | • Cleveland |
| | • King 2350 | • Holton |
| \$1000 | • \$500 Each | • Olds |
| for SILVER | • for SILVER | • Pan American |
| Conn 20K | • Conn 14K or | • Reynolds |
| | • King 2350 | |



WANTED

Used Bb Fiberglass Sousaphones



DESCRIPTION

We need Sousaphones to Overhaul this winter for next years' marching season.

We will arrange pick up and pay all shipping charges for groups of 3 or more sousaphones.

Sousaphones must be complete and overhauled.

Price adjustment will be made on damaged or very poor quality models. (Chipped, Cracked Bells, Holes, Busted Braces, etc.)

REWARD

- | | |
|-------------------|---------------------|
| \$250 Each | • \$400 Each |
| for Bundy | • for Conn 22K |
| Jupiter | • Conn 36K |
| Olds | • King 2370 |
| Reynolds | • Yamaha |
| Signet | |

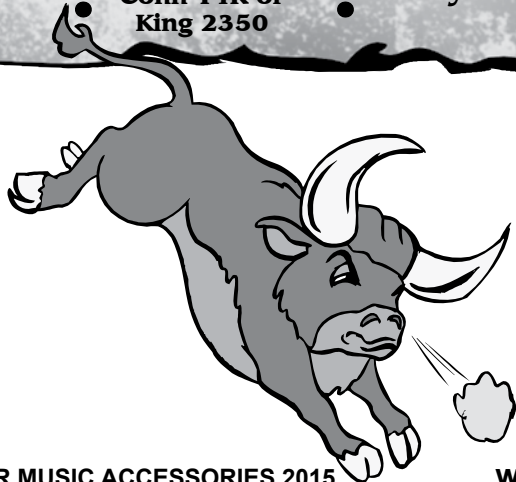

EVEN STEVEN TRADING

Director's Name: _____
 School Name: _____
 School Address: _____
 City: _____
 State: _____
 Zip: _____
 Phone: _____
 Fax: _____
 Email: _____



Items I Want to Trade:

	Instrument	Brand	Finish	Condition	Comments
Example	<i>Trumpet</i>	<i>Bundy</i>	<i>Brass</i>	<i>Fair</i>	<i>Missing 1st Valve</i>
Example	<i>Clarinet</i>	<i>Vito</i>	<i>Plastic</i>	<i>Good</i>	<i>Complete & Playable</i>

*** If you have more instruments for trade, please attach another sheet.*

Items I Want:

HERE'S HOW IT WORKS

- 1. SEND** us your list of items you have to trade
- 2. LIST** the items you wish to acquire
- 3. WE'LL** look over your list and contact you with our proposal
- 4. IF** you like our offer, we'll assist you with shipping information for sending your trades and begin processing your order

Contact Information:**Toll Free: 1-800-872-2263**

Local: 1-605-225-1335

Fax #: 1-605-225-2051

Website: www.taylormusic.comEmail: music@taylormusic.com**Taylor Music, Inc.**513 South Main Street
Aberdeen, SD 57401**Store Hours:**

Monday - Friday / 8:30 - 5:30 CST

Payment Methods Available**Paying with Credit Cards:** We accept Visa, MasterCard, Discover and American Express credit/debit cards.**For the protection of our customers, all credit card orders are subject to name and address verification.****Checks & Money Orders:** We accept Checks and Money Orders for mail orders. A \$40 fee will be charged for returned checks.**COD is not available.**

Order Processing

Orders begin processing upon receipt and are normally shipped within 2-3 business days. If there is a delay in your order, we will notify you by email or by phone.

Back Ordered Items

There are times when an item may be backordered. If any product is not available, we will contact you by email or phone with up to date delivery information.

School Purchase Guidelines - We Welcome School Purchase Orders!Schools wishing to place an order; send us a school purchase order. Mail in the hard copy or Fax the order to **1-605-225-2051**.Or simply give us a call **1-800-872-2263** and place your order via phone.**Shipping & Verifying School Orders:** All school orders will be shipped to their official school address only. For security reasons, it may be necessary for us to verify your order with the school. To avoid processing delays, please provide the most accurate billing and shipping information available.**School Payment Terms:** Payment on school orders are net 30 days. Your school will receive a monthly statement along with invoice copies.

Returns & Exchanges**30 Day Money Back Guarantee**

Your satisfaction is our top priority. If you find anything not to your liking, return the item within 30 days from date of invoice for a full refund or exchange less the shipping costs. (Some Special Order Items are Non-Returnable.) Returns must be in the same condition as when received with original packaging. We inspect returns and upon approved inspection, your purchase will be refunded. Returns not in the original condition or incomplete may be subject to a charge.

Return shipping will be at your expense. Please return your merchandise prepaid by a traceable method (a tracking number) as we are not responsible for lost packages being returned.

Shipping Options**UPS is our primary shipping carrier.** Accessory orders under \$75.00 will be charged a \$12.00 shipping fee.**FREE Shipping** applies only to contiguous UPS Ground Shipments on qualifying orders over \$75.00.**Methods:****48 States:** UPS Ground, UPS 2nd Day Air, UPS Next Day Air and Spee-Dees (where available)**Alaska and Hawaii:** USPS Priority Mail, UPS Ground, UPS 2nd Day Air and UPS Next Day Air**AA, AE, AP, GU, VI, PR Shipments:** USPS Priority Mail**UPS Delivery Information:** UPS will not deliver to P.O. Boxes. You must provide a valid street address for us to ship your order by UPS.

Unless specifically requested, we do not require a signature for deliveries. It is solely up to the carrier's discretion whether or not to leave a package at your door if no one is home. For your protection, please ship to an address where someone will be there to accept the package.

Truck Shipments:

Truck shipments may be necessary for larger items. Once your order is received, we will notify you with an estimated cost on truck shipping. You will have the option to cancel your order if necessary. Larger truck items include: Tuba & Sousaphone Cases, Percussion Cases, Carts & Podiums, etc.

We reserve the right to correct typographic and photographic errors.**Prices subject to change without notice.****We cannot guarantee that published prices in this catalog will remain constant.****For the current price on any item, please call our sales department.**

Index

A

Accent Sticks.....	35
Accessory Packages.....	8
Accessory Trays.....	51
Adaptor, Boss AC.....	20
Afuche.....	38
Alto/Bass Clarinet Strap.....	13
Angle Reduction Bar.....	61

B

B.E.R.P.....	6
Barbells.....	38
Baritone/Tuba Strap.....	13
Bari Sax Strap.....	13
BarTies, Replacement.....	39
Bar Chimes.....	39
Bassoon Seat Strap.....	13
Bass Drum Stand.....	52,53
Batons.....	9
Bells, Agogo.....	38
Bells, Hand Held.....	38
Bells, Ice.....	38
Bells, Jam.....	38
Bells, Sleigh.....	38
Bell Set.....	40
Bell Tree.....	38
Blocks, Granite.....	41
Blocks, Jam.....	41
Blocks, Moon.....	41
Blocks, Temple.....	41
Blocks, Wood.....	41
Bongos.....	45
Books.....	17,18
Boomwhackers.....	37
Bore Oil.....	11
Bows, Violin/Viola/Cello.....	23
Brace Lip Guard.....	7
Brace Lip Protector.....	7

C

Cabasa.....	38
Cables, Microphone.....	20
Cajons.....	45
Case, Alto Clarinet.....	65
Case, Alto Sax.....	65
Case, Bari Sax.....	66
Case, Baritone.....	69
Case, Bassoon.....	65
Case, Bass Clarinet.....	65
Case, Bass Trombone.....	68
Case, Chime.....	39
Case, Clarinet.....	64
Case, Concert Snare.....	72
Case, Contra Alto Clarinet.....	65
Case, Cornet.....	67
Case, Cymbal.....	74
Case, Drum Set.....	73
Case, Euphonium.....	69
Case, Flugelhorn.....	67
Case, Flute.....	64
Case, French Horn.....	68
Case, Marching Bass Drum.....	72,73
Case, Marching Drum.....	73
Case, Marching Horn.....	69
Case, Marching Snare.....	72
Case, Marching Tom.....	72
Case, Marching Trombone.....	69
Case, Oboe.....	64
Case, Piccolo.....	64

Case, Plume.....	58
Case, Soprano Sax.....	66
Case, Sousaphone.....	70
Case, Tenor Sax.....	66
Case, Trombone.....	68
Case, Trumpet.....	67
Case, Tuba.....	70,71
Case, Viola/Violin.....	66
Castanets.....	41
Chime Mallet.....	33
Chime Cases.....	39
Chime Damper Bracket.....	39
Chime Mounting Bracket.....	39
Clarinet/Oboe Strap.....	13
Clarinet Barrel.....	5
Claves.....	41
Chime Mounting Bracket.....	39
Cleaning Kits.....	8
Cleaning-Polishing Cloths.....	7
Cleaning Coil/Snake.....	7
Cleaning Rods.....	8
Cloth, Orchestra Polishing.....	22
Congas.....	45
Cork Grease.....	11
Covers, Drum.....	73
Cowbell Beaters.....	40
Cowbells.....	40
Crotale Bag.....	49
Crotales.....	49
Cymbals.....	46-49
Cymbals, Finger.....	49
Cymbal Bag.....	74
Cymbal Cleaner.....	49
Cymbal Packages.....	46
Cymbal Pads & Straps.....	49

D

Dampening Rings.....	31
Disinfectant Spray.....	12
Drum Brushes.....	35
Drum Covers.....	73
Drum Heads.....	28-31
Drum Hoops.....	62
Drum Keys.....	62
Drum Pedals.....	55
Drum Rims.....	62
Drum Set Bags.....	74
Drum Sling.....	61
Drum Stick Bag.....	75
Drum Sticks.....	33
Drum Thrones.....	55

E

End Pin Holder.....	22
End Plug.....	7

F

Field Frame Attachments.....	58
Field Frames.....	58
Flexatone.....	40
Flip Folios.....	15
Flip Folio Rings.....	15
Flip Folio Windows.....	15
Folders, Band.....	18

G

Gongs.....	50
Gong Stands.....	50
Grime Gutter.....	8
Guiro.....	40

H

Headsets.....	19
Holder, iPad-Tablet.....	27
Humidifiers.....	22

J

Jingle Sticks.....	42
--------------------	----

L

Ligatures.....	6
Lip Ease.....	7
Lip Guard.....	7
Lip Protector.....	7
Liquid Slide Cream.....	11
Lubricants/Oils.....	11
Lyres.....	15

M

Mallets, Bell.....	33
Mallets, Chime.....	33
Mallets, Concert Bass.....	33-36
Mallets, Cymbal.....	34
Mallets, Gong.....	34,50
Mallets, Keyboard.....	33-36
Mallets, Marching.....	33-36
Mallets, Timpani.....	33-36
Mallets, Tom.....	33-36
Maracas.....	42
Marching Drum Covers.....	73
Metronome.....	20
Mic.....	19,21
Microphones.....	20
Moisturizer, ChopSaver.....	12
Moto-Carts, Mallet.....	57
Mounts, Percussion.....	52
Mouthpiece Puller.....	7
Mouthpieces, Alto Clarinet.....	5
Mouthpieces, Alto Sax.....	5
Mouthpieces, Bari Sax.....	5
Mouthpieces, Bass Clarinet.....	5
Mouthpieces, Brass.....	4
Mouthpieces, Clarinet.....	5
Mouthpieces, Cornet.....	4
Mouthpieces, Soprano Sax.....	5
Mouthpieces, Tenor Sax.....	5
Mouthpieces, Trumpet.....	4
Mouthpieces, French Horn.....	4
Mouthpieces, Marching.....	4
Mouthpieces, Trombone.....	4
Mouthpieces, Tuba/Sousa.....	4
Mouthpiece Adaptor.....	6
Mouthpiece Brushes.....	8
Mouthpiece Caps.....	7
Mouthpiece Disinfectant Spray.....	12
Mouthpiece Kit.....	6
Mouthpiece Pouch.....	8
Mouthpiece Resistance Piece (B.E.R.P.).....	6
Mouthpiece Savers.....	7
Mouthpiece Swab.....	8
Mover, Equipment.....	57,58
Mover, Keyboard.....	57
Mover, Mallet.....	57
Mover, Platform.....	57
Mover, Uniform & Hat.....	58
Mover, Utility Band Wagon.....	57
Muff'l Strips.....	31
Music Stands.....	24,25
Mutes, Instrument.....	16
Mutes, String.....	22

N

Name Tags	12
Neck Straps	13

O

Oil, Bore	11
Oil, Key	11
Oil, Slide	11
Oil, Valve	11

P

Pad Guards	8
Pad Savers	8
Palm Key Risers	7
PA Sound System	19
Pedal Beater	55
Percussion Holders & Mounts	52
Percussion Workstation	51
Pitchpipe	21
Podiums	59,60
Polishing Cloths	7,22
Polish Cleaner	22
Practice Pads	31
Protecto Pads	10

R

Racks, Storage	26
Rainsticks	44
Ratchet	44
Recorders	9
Reedgard	6
Reeds	3
Repair Kits	14
Rim Saver	61
Rim Shooter	61
Rosin	22

S

Saxophone Harness	13
Sax End Plug	7
Sax Neck Saver	8
Sax Palm Key Risers	7
Shakers	44
Shoulder Pads	23
Shoulder Rests	23
Silent Brass Mutes	16
Silver Polish	12
Silver Polish Spray	12
Slapstick	42
Slide Cream	11
Slide Lubricant	11,12
Slide Oil	11
Slide Treatment	11
Snare, Laptop	31
Snare Strainer	61
Sound Dampening Rings	31
Sound Projectors	61
Sousaphone Neck & Bits	10
Sousaphone Pouch	10
Sousa Protecto Pads	10
Spray Bottle	11
Stand Cart	25
Stand Conversion Kit	25
Stand Lights	24
Stands, Alto/Tenor Sax	27
Stands, Bari Sax	27
Stands, Baritone	26,27
Stands, Bass Clarinet	26,27
Stands, Bass Drum	52,53

Stands, Bassoon	26,27
Stands, Bell	56
Stands, Cymbal	54
Stands, Flugelhorn	27
Stands, Flute/Clarinet	26,27
Stands, French Horn	27
Stands, Gong	50
Stands, Hardware	54
Stands, Keyboard	56
Stands, Low Brass	26,27
Stands, Marching	56
Stands, Music	24,25
Stands, Percussion	41,42
Stands, Sax	26,27
Stands, Snare Drum	54,56
Stands, Stadium	56
Stands, Trombone	26,27
Stands, Trumpet	26,27
Stands, Tuba	26,27
Sterisol	12
Stick/Mallet Bags	75
Storage Rack	26
Strap, Cello Anchor	22
Strap, French Horn	9
Strings, Violin/Viola Cello	23
Swab, Absorbent	9
Swab, Alto/Bass/Contra Clarinet	9
Swab, Bassoon	9
Swab, Oboe	9
Swab, Sax	9
Swabs, Silk	9
Swab, Wire Handle	9

T

Tambourines	42
Teeth Cushion	7
Temple Blocks	41
Tension Rods	61
Thumb Saver	7
Timbales	45
Timpani Covers	63
Timpani Heads	28
Timpani Throne	55
Timpani Tuners	63
Torque Wrench Key	62
Trap Table	51
Triangle Clip Holder	43
Triangles	43
Triangle Beaters/Strikers	43
Triangle Holders	43
Trombone, Jiggs	24
Trombone Slide Extension	8
Trombotine Slide Lubricant	11,12
Trumpet, Jiggs	24
Tuba Harness	13
Tuba Shield	10
Tuba Stand	26,27
Tuners	21
Tuning Gauge	63
Tuning Keys	62

V

Valve Guard	9
Valve Oil	11,12
Vibraslap	40

W

Whistles	44
----------------	----

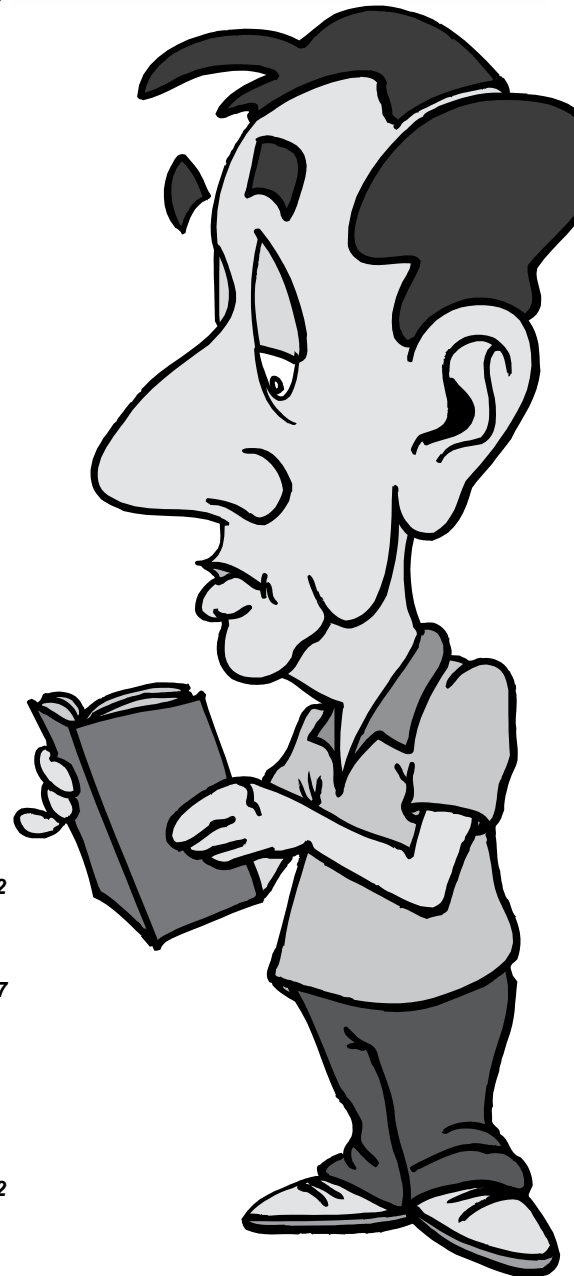



pBone

Jiggs pBone Plastic Tenor Trombone

A plastic Tenor Trombone endorsed by Jiggs Whigham. Plastic construction, this lightweight instrument sounds remarkably like typical brass trombones.

.509" bore, 8" bell

Fiberglass slide with brass slide stockings on the inner handslide to keep the slide moving freely.

The handslide with feel smoother the more you play the instrument, and you can even play the instrument without the need for slide lubrication.

Includes a plastic mouthpiece & carrying bag.



\$179

each

Color Options:

- PBONE1BLK - Black
- PBONE1B - Blue
- PBONE1G - Green
- PBONE1O - Orange
- PBONE1PNK - Pink
- PBONE1P - Purple
- PBONE1R - Red
- PBONE1W - White
- PBONE1Y - Yellow



HOT BUY!

Leblanc 7860 Bliss Bb Clarinet Case

Lightweight (1.9 lbs) Softshell case with zipper closure. Durable construction. Black cloth covering with black plush internal lining. Designed to fit all Bb clarinets. Side zippered compartment holds phone, calculator, pens, etc. Side webbing holds a water bottle. Matching cloth handle on top side. Back pack straps with reflector strips on straps and front side of case. List \$68.25



\$20

Buy 5 Get 6th FREE!



Conn-Selmer 50745 Tenor Sax Case

Imported by Conn-Selmer for student models. No logo on case. Lightweight (8 lbs). Durable plastic shell, heavy duty with gold aluminum valance and latches. Black plush interior. Detachable shoulder strap. Separate compartment for neck. Large internal compartment for accessories. Interior nesting is designed to hold older and newer models with bell keys on either side. List \$297

\$95

***Universal Fit! We have not found a tenor sax that does not fit into this case!**

Buy 3 Get 4th FREE!



Find us on
Facebook
[fb.com/TaylorMusicInc](https://www.facebook.com/TaylorMusicInc)



March - April 2015



WWW.TAYLORMUSIC.COM
1.800.872.2263

 Find us on
Facebook
fb.com/TaylorMusicInc

Jupiter US Army All American Band Specials

These were new instruments used by some of America's finest for a one week clinic and performance.

Very minor dents and scratches. Completely cleaned and adjusted.

JUPITER®

Jupiter 301S Piccolo

Used, Excellent! Very minor finish scratches. Completely cleaned and adjusted.

Silver plated head, body and keys
Cylindrical bore
Includes molded case
List \$995

\$425



Jupiter 635N Bb Clarinet

Used, Excellent! Very minor finish scratches. Completely cleaned and adjusted.

Student Model
ABS resin, matte finish, nickel silver bell ring
Forged nickel-plated nickel silver keys
.577" Bore, Offset Trill Keys
65mm barrel
Comfortable C/G key riser
Undercut tone holes
Adjustable thumb rest, adjustable neck strap
Includes mouthpiece and ABS molded case
List \$875

\$325



Jupiter 769GN Alto Saxophone

Used, Excellent! Very minor dents & scratches. Completely cleaned and adjusted.

Student Model
Lacquered brass body
Nickel plated keys
High F#
Tilting G#-Bb table keys
Adjustable thumb rest
Metal tone boosters
Includes mouthpiece & wood shell case
List \$1995

\$750

Jupiter 789GN Tenor Saxophone

Used, Excellent! Very minor dents & scratches. Completely cleaned and adjusted.

Student Model
Lacquered brass body
Nickel plated keys
High F#
Tilting G#-Bb table keys
Adjustable thumb rest
Metal tone boosters
Includes mouthpiece & wood shell case
List \$2435

\$950



Limited Quantities Available!

No Trade Required!

Armstrong Intermediate Flutes

Armstrong 303BOS Intermediate Flute

Demo Model; minor finish scratch.
Completely cleaned and polished.

Intermediate Model
Open hole (French Style)
Sterling silver (.925) head
Silver plated body, foot and keys
Range to low B
Offset G
Includes case and case cover
List \$1770

10 Payments of
\$75

**No Trade Required or
Single Payment of \$750 NT**

Armstrong



Armstrong 808BOF Intermediate Flute

Demo Model; minor finish scratch. No Dents!
Completely cleaned and adjusted.

Professional Model
Range to Low B
French style (open hole) keys
Sterling silver head, body & foot
Silver plated keys
Gold plated lip plate and crown
Offset G
Includes French style case with fleece lined cover
List \$2039

10 Payments of
\$115

**No Trade Required or
Single Payment of \$1150 NT**

Limited Quantities Available!

Pearl Professional Pristine Silver Flutes

Pearl 9700RB/F9700 Flutes Maesta Pristine Silver Series Professional Handmade Model

New!

Forte Headjoint

.970 Pristine silver (.40mm). Designed for larger orchestras and concert halls. Very responsive. Produces a dark centered tone. A wide dynamic range is ensured throughout the entire registers.

9700 Series Features:

Solid Pristine Silver .970 tube (.40mm)

.925 Solid sterling silver keys

Open hole

Drawn tone holes with pointed key arms

White gold springs

Pearl's pinless construction & one piece core bar

Range to low B

Inline G

Includes French style wood case & padded case cover, cleaning rod and polishing cloth.

List \$6979



10 Payments of
\$345

**No Trade Required or
Single Payment of \$3450 NT**

**50%
OFF SALE**

Pearl 9700RBH/VI9700H Flutes Maesta Pristine Silver Series Professional Handmade Model

New!

Pearl Custom Features:

Heavy Wall (.45mm) Headjoint and Body tubes

Vivace Headjoint

.970 Pristine silver (.45mm) that offers a combination of a dark centered tone with crisp, clear articulation. Players desiring more resistance will enjoy this headjoint.

9700 Series Features:

Solid Pristine Silver .970 tube (.45mm)

.925 Solid sterling silver keys

Open hole

Drawn tone holes with pointed key arms

White gold springs

Pearl's pinless construction & one piece core bar

Range to low B

Inline G

Includes French style wood case & padded case cover, cleaning rod and polishing cloth.

List \$6979



10 Payments of
\$345

**No Trade Required or
Single Payment of \$3450 NT**

**50%
OFF SALE**

Pearl 9700RBCD/F9700 Flutes Maesta Pristine Silver Series Professional Handmade Model

New!

Pearl Custom features:

C# Trill Key

D# Roller

Forte Headjoint

.970 Pristine silver (.40mm). Designed for larger orchestras and concert halls. Very responsive. Produces a dark centered tone. A wide dynamic range is ensured throughout the entire registers.

9700 Series Features:

Solid Pristine Silver .970 tube (.40mm)

.925 Solid sterling silver keys

Open hole

Drawn tone holes with pointed key arms

White gold springs

Pearl's pinless construction & one piece core bar

Range to low B

Inline G

Includes French style wood case & padded case cover, cleaning rod and polishing cloth.

List \$8102



10 Payments of
\$395

**No Trade Required or
Single Payment of \$3950 NT**

**50%
OFF SALE**

Limited Quantities Available!

Pearl Professional Pristine Silver Flutes

Pearl 9701RBCH/F9700H Flutes Maesta Pristine Silver Series Professional Handmade Model

New!

Pearl Custom Features:

C# Trill

Forte Heavy Wall (.45mm) Headjoint

.970 Pristine silver (.45mm). Designed for large orchestras and concert halls. Very responsive and produces a dark centered tone. A wide dynamic range is ensured throughout the entire registers.

9701H Series Features:

Solid Pristine Silver .970 tube (.45mm)

.925 Solid sterling silver keys

Open hole

Soldered tone holes with pointed key arms

White gold springs

Pearl's pinless construction & one piece core bar

Range to low B

Inline G

Includes French style wood case & padded case cover,
cleaning rod and polishing cloth.

List \$8480



10 Payments of
\$415

**No Trade Required or
Single Payment of \$4150 NT**

**50%
OFF SALE**

Pearl 9701RBCDD/V19700S Flutes Maesta Pristine Silver Series Professional Handmade Model

New!

Pearl Custom Features:

C# Trill

C# Roller

D# Roller

Vivace Headjoint with Engraved Lip plate

.970 Pristine silver (.40mm) that offers a combination of a dark centered tone with crisp, clear articulation. Players desiring more resistance will enjoy this headjoint.

9701 Series Features:

Solid Pristine Silver .970 tube (.40mm)

.925 Solid sterling silver keys

Open hole

Soldered tone holes with pointed key arms

White gold springs

Pearl's pinless construction & one piece core bar

Range to low B

Inline G

Includes French style wood case & padded case cover,
cleaning rod and polishing cloth.

List \$9602



10 Payments of
\$475

**No Trade Required or
Single Payment of \$4750 NT**

**50%
OFF SALE**

Pearl®

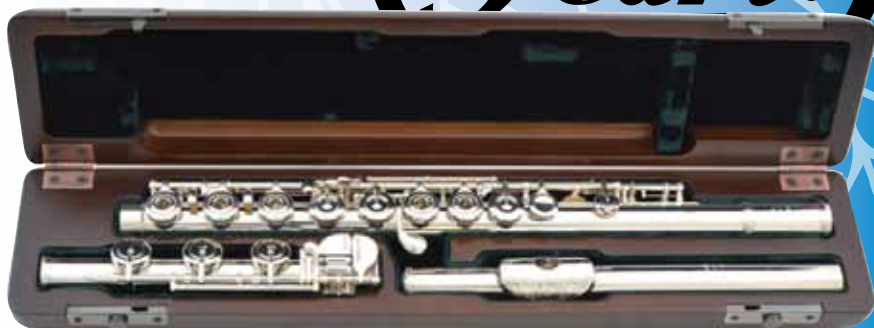

Limited Quantities Available!

CLARINETS



Artley 72S USA Wood Bb Clarinet

Beginner Return; used for 1 year or less.
Completely cleaned and adjusted.

Artley USA Student Model previously
distributed by Conn-Selmer
Grenadilla wood body
Nickel plated keys with locking pins on lower joint posts
Tapered bore
Undercut tone holes
Adjustable thumb rest
Includes mouthpiece and durable plastic case
List \$NA

Artley®



10 Payments of \$45

Limited Quantities Available!

**No Trade Required or
Single Payment of \$450 NT**



Selmer CL201 USA Wood Bb Clarinet

Beginner Return; used for 1 year or less.
Completely cleaned and adjusted.

Selmer USA Student Model
Ergonomic keys & rings
Grenadilla wood body
Undercut tone holes
Nickel plated keys
.573" Reamed bore
Includes case & mouthpiece
List \$1836

Selmer®



10 Payments of \$60

**No Trade Required or
Single Payment of \$600 NT**



Leblanc LB210 Bliss Bb Clarinet

New!

Discontinued Step-Up USA Model distributed by Conn-Selmer

Grenadilla upper and lower joints

Bliss grenadilla barrel and bell

.575" bore

Black nickel keys

Black Valentino synthetic pads (extend pad life and improve tone hole seating)

Overcut and undercut tone holes; overcut guides fingers into tone holes making fingering easier and more secure. Both provide more secure and consistent tuning.

Adjustable thumb rest

Low E Reinforcement bar

Includes plastic student mouthpiece, D. Bonade inverted ligature & cap and lightweight, backpack style case.

List \$1890

LEBLANC® 



10 Payments of
\$75

No Trade Required or
Single Payment of \$750 NT



Noblet L45 Bb Clarinet

New!

Intermediate Paris Model built by Leblanc

Select grenadilla wood body

Nickel plated keys

.584" cylindrical bore

Separate post mounted C#/G# keys

Includes Leblanc mouthpiece

List \$1975

NOBLET 

Case Options:

L45 with Wood Shell Case

L45CA with Carry All Case



10 Payments of
\$80

No Trade Required or
Single Payment of \$800 NT



Noblet Paris 55 Bass Clarinet

Reconditioned! Our Best Overhaul! New pads. Completely cleaned and adjusted.

Intermediate Paris Model
Grenadilla wood body
New nickel plated keys, bell and neck
Key of Bb, range to low Eb
Includes Debut mouthpiece and
new one piece case
List \$NA



Noblet 
10 Payments of
\$195

**No Trade Required or
Single Payment of \$1950 NT**

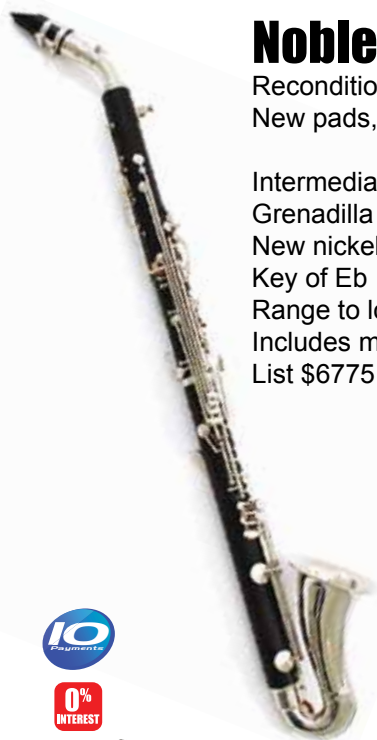

Noblet Paris 60N Alto Clarinet

Reconditioned, Our Best Overhaul!
New pads, completely cleaned and adjusted.

Intermediate Paris Model
Grenadilla wood body
New nickel plated keys, bell and neck
Key of Eb
Range to low Eb
Includes mouthpiece and case
List \$6775



Noblet 
10 Payments of
\$75

**No Trade Required or
Single Payment of \$750 NT**



Leblanc 350 Paris Eb Contra Alto Clarinet

Econo Overhaul! Original nickel plated finish on body and keys. New pads; completely cleaned and adjusted.

Professional Paris Model
Curved body
Nickel silver metal body
Nickel plated keys
Key of EEb
Range to low C
Single automatic register key
Includes mouthpiece and new wood shell case
List \$NA

\$4950
no trade required

Leblanc 342 Paris Bb Contra Bass Clarinet

Econo Overhaul; New pads
Completely cleaned and adjusted.

Professional Paris Model
Two Piece metal body; Straight Style
Original nickel plated finish on body and keys
Key of BBb
Range to low Eb
Single automatic register key
Includes mouthpiece
and new wood shell case
List \$NA

\$5250
no trade required



Leblanc 340 Paris Bb Contra Bass Clarinet

Econo Overhaul! Original nickel plated finish on body and keys. New pads; completely cleaned and adjusted.

Professional Paris Model
Curved body
Nickel silver metal body
Nickel plated keys
Key of BBb
Range to low D
Single automatic register key
Includes mouthpiece and new wood shell case
List \$NA

\$5750
no trade required

Miscellaneous Oboes

F. Platz USA Full System Oboe

Econo Overhaul! New pads. Completely cleaned and adjusted. Professional USA Model (Elkhart, IN). Full Conservatory System (except Split E key). **Includes Left hand F key and F Resonance key.** Grenadilla wood body (pinned & sealed). Range to low Bb. Includes plastic French style case. List \$NA

10 Payments of \$135

**No Trade Required or
Single Payment of \$1350 NT**

Gordet Paris Full System Oboe

Econo Overhaul! New pads. Keys polished and cleaned. Completely cleaned and adjusted. Professional Paris Model. Full Conservatory System includes Split E key, **left hand F and F resonance key.** Grenadilla wood body; no cracks. Bright silver finish. 3rd Octave key. Metal tenon sockets. Range to low Bb. New French style case with cloth wrap. List \$NA

10 Payments of \$225

**No Trade Required or
Single Payment of \$2250 NT**

Larilee 400W USA Full System Oboe

Reconditioned! Our Best Overhaul! New pads. New bright silver plated keys. Completely cleaned and adjusted. Professional USA Model (Elkhart, IN). Full Conservatory System. Includes Split E key, 3rd Octave key, **left hand F key & F Resonance key.** Grenadilla wood body (no cracks). Range to low Bb. Includes original Larilee wood shell case and padded cover (like new condition). List \$NA

10 Payments of \$195

**No Trade Required or
Single Payment of \$1950 NT**

Selmer 1292 Student Oboe

Reconditioned! Our Best Overhaul! New pads. New bright silver plated keys. Completely cleaned and adjusted. Selmer USA Student Model. Basic System. Grenadilla wood body. Silver plated keys. Range to low B. Includes new case. List \$NA

10 Payments of \$95

**No Trade Required or
Single Payment of \$950 NT**

Selmer 121 Full System Oboe

Demo Model; minor finish scratch. Completely cleaned and adjusted. Performance Model. Grenadilla wood body. Full conservatory system. **Fork F resonance.** Ab-Bb trill, G#-A trill, Double ring D#-E. Left-hand C-D trill, Auxilliary C. Low Bb key. Silver plated key mechanism. Includes case. List \$4259

10 Payments of \$195

**No Trade Required or
Single Payment of \$1950 NT**

F. Platz USA Full System Oboe

Reconditioned! Our Best Overhaul! New pads. New bright silver plated keys. Completely cleaned and adjusted. Professional USA Model (Elkhart, IN). Full Conservatory System (except Split E key). **Includes Left hand F key and F Resonance key.** Grenadilla wood body (pinned & sealed). Range to low Bb. Includes plastic French style case. List \$NA

10 Payments of \$165

**No Trade Required or
Single Payment of \$1650 NT**

Armstrong 5010W Basic System Oboe

Econo Overhaul! New pads. Completely cleaned and adjusted. USA Modified System Oboe. Basic System with added D trill bridge lever, D lever and range to low Bb. Grenadilla wood upper & lower body (no cracks). Plastic bell with wood grain finish. Silver plated keys. Includes new case List \$NA

10 Payments of \$105

**No Trade Required or
Single Payment of \$1050 NT**



Selmer Bassoons

Selmer 1432B Bassoon

Demo Model; minor finish scratch.
Completely cleaned and adjusted.

Student USA Model
High-impact plastic body
Nickel plated key mechanism
Heckel system
High C key, F # trill, large ring A and C#-D# trills
Rollers for C#-D# and F-Ab
Kid leather pads
Includes two bocals, wood shell case
List \$5886

10 Payments of
\$295

**No Trade Required or
Single Payment of \$2950 NT**

Selmer®

Selmer 132 Bassoon

Demo Model; minor finish scratch.
Completely cleaned and adjusted.

Selmer Intermediate USA Model Bassoons
Hard maple body
Nickel plated key mechanism
Heckel system with High D key
F # trill, large ring A and C#-D# trills
Rollers for C#-D# and F-Ab
Kid leather pads
Includes two bocals, wood shell case
List \$8064

10 Payments of
\$395

**No Trade Required or
Single Payment of \$3950 NT**

Selmer®

Selmer Clarinets



Selmer Bundy 1405 Eb Clarinet

Econo Overhaul; new pads.
Completely cleaned and adjusted.

Selmer Bundy USA Eb Clarinets
High impact plastic body
Straight tone holes
Nickel plated keys
Includes new case and mouthpiece
List \$NA

Selmer®

\$650

No Trade Required!



Selmer Bundy 1440 Contra Alto Clarinet

Econo Overhaul! New pads.
Completely cleaned and adjusted.

USA Contra Alto Clarinets built by Selmer
One piece plastic body
Nickel plated keys
Key of Eb
Range to low Eb
.987" bore
Includes mouthpiece and new wood shell case
List \$3610

Selmer®

\$1750

No Trade Required!

Intermediate Soprano Saxophones



Selmer®

Selmer SSS280R La Voix II Soprano Sax

New!
Intermediate Model
Straight one piece body
Rose brass body with yellow brass keys
Clear lacquer finish
Nickel silver rods
High F# key
Includes Selmer USA mouthpiece and backpack style case
List \$3927

10
Payments

0%
INTEREST

FREE SHIPPING
U.S. Contiguous

10 Payments of
\$279⁹⁰

**No Trade Required or
Single Payment of \$2799 NT**



YAMAHA

Yamaha YSS475II Soprano Sax

New!
Intermediate Model
Epoxy lacquer finish on body and keys
Refined tone hole dimension and placement
Adjustable key guard felts allow for superior intonation
Front F and High F#
Tapered pivot screws
Custom style low Bb spatula
Adjustable thumb rest
Key of Bb

Straight one piece body and neck
Custom style key mechanism
Includes case and mouthpiece
List \$3601

10
Payments

0%
INTEREST

FREE SHIPPING
U.S. Contiguous

10 Payments of
\$243⁹⁰

**No Trade Required or
Single Payment of \$2438.99 NT**



JUPITER®

Jupiter 547GL Soprano Sax

New!
Intermediate Model
Straight One piece body
Gold lacquered body and keys
High F#
Tilting G#-Bb spatula keys
Includes mouthpiece and wood shell case
List \$2455

10
Payments

0%
INTEREST

FREE SHIPPING
U.S. Contiguous

10 Payments of
\$161³⁰

**No Trade Required or
Single Payment of \$1613 NT**

No Trades Required!

Intermediate Alto Saxophones



Selmer AS42 Alto Sax

New!
Entry Level Professional Model. A collaboration between Henri Selmer Paris and Selmer USA Models. Plays remarkably well in Classical and Jazz situations
Henri Selmer Paris custom designed neck
Hand engraved clear lacquered brass
High F# key
Multiple adjusting screws
Rocking table mechanism
Blue steel springs
Treated leather pads with metal resonators
Ribbed construction
Exclusive AM42 Selmer Paris mouthpiece
BAM Case
List \$4246



Selmer[®]

10 Payments of
\$291⁹⁰

**No Trade Required or
Single Payment of \$2919 NT**



Yamaha YAS480 Alto Sax

New!
Intermediate Model
Key of Eb
Separate key guards
Hand engraving; 62 style neck
Newly redesigned octave key mechanism
Rocker type low B mechanism
Front F and high F# key
Epoxy lacquer finish on body and keys
Tapered pivot screws;
Custom style low Bb spatula
Adjustable thumb rest;
Adjustable key guard felts
Includes case and mouthpiece
List \$3344



 **YAMAHA**

10 Payments of
\$239¹⁰

**No Trade Required or
Single Payment of \$2390.99 NT**



Jupiter JAS1100 Alto Sax

New!
Intermediate Model (replaces 1167GL)
Hand Crafted Sona-Pure brass neck
Lacquered brass body and keys
Adjustable palm keys
Engraved bell
High F#
Adjustable front F
Tilting G# - Bb table keys
Upper and lower stack adjustment screws
Adjustable G and rocker octave mechanisms
Blued steel springs
Metal tone boosters
Lightweight FQ Series form-fitted zippered case with shoulder straps
Includes mouthpiece
List \$2995



JUPITER[®]

10 Payments of
\$199⁵⁰

**No Trade Required or
Single Payment of \$1995 NT**

Intermediate Tenor Saxophones



Selmer TS44 Tenor Sax

New!
Entry Level Professional Model. A collaboration between Henri Selmer Paris and Selmer USA Models. Plays remarkably well in Classical and Jazz situations
Henri Selmer Paris custom designed neck
Hand engraved clear lacquered brass
High F# key
Multiple adjusting screws
Rocking table mechanism
Blue steel springs
Treated leather pads with metal resonators
Ribbed construction
Exclusive AM42 Selmer Paris mouthpiece
BAM Case
List \$4210



Selmer®

10 Payments of
\$289⁹⁰

**No Trade Required or
Single Payment of \$2899 NT**



Yamaha YTS480 Tenor Sax

New!
Intermediate Model
Key of Bb
Separate key guards
Hand engraving
Tenor Saxes have 62 Series style neck
Newly redesigned octave key mechanism
Rocker type low B mechanism
Front F and high F# key
Epoxy lacquer finish on body and keys
Tapered pivot screws;
Custom style low Bb spatula
Adjustable thumb rest
Adjustable key guard felts
Includes case and mouthpiece
List \$3838



YAMAHA

10 Payments of
\$275⁰⁰

**No Trade Required or
Single Payment of \$2750 NT**



Jupiter JTS1100 Tenor Sax

New!
Intermediate Model (replaced 1187GL)
Hand Crafted Sona-Pure brass neck
Lacquered brass body and keys
Adjustable palm keys
Engraved bell
High F#
Adjustable front F
Tilting G# - Bb table keys
Upper and lower stack adjustment screws
Adjustable G and rocker octave mechanisms
Blued steel springs
Metal tone boosters
Lightweight FQ Series form-fitted zippered case with shoulder straps
Includes mouthpiece
List \$3450



JUPITER®

10 Payments of
\$229⁵⁰

**No Trade Required or
Single Payment of \$2295 NT**

Intermediate Bari Saxophones



Selmer BS500 Bari Sax

New!
Key of Eb
Clear lacquer finish
High F#
Range to low A
Double arm low C & B keys
Table key arch brace
Two bell-body braces
Includes case and mouthpiece
List \$6892

Selmer[®]



0%
INTEREST



10 Payments of
\$497⁹⁰

**No Trade Required or
Single Payment of \$4979 NT**



Yamaha YBS52 Bari Sax

New!
Epoxy lacquer finish on body and keys
Refined tone hole dimension & placement
Adjustable key guard felts allow for superior intonation
Front F and high F# allow more alternate fingerings
Tapered pivot screws
Custom style low Bb spatula
Adjustable thumb rest
Key of Eb
Range to low A
Includes case and mouthpiece
List \$8306

 **YAMAHA**



0%
INTEREST



10 Payments of
\$547²⁰

**No Trade Required or
Single Payment of \$5471.99 NT**



Jupiter 593GL Bari Sax

New!
Gold lacquered body and keys
Key of Eb
Range to low A
High F#
Tilting G#-Bb spatula keys
Includes mouthpiece and wood shell case
List \$5940

JUPITER[®]



0%
INTEREST



10 Payments of
\$422⁶⁰

**No Trade Required or
Single Payment of \$4226 NT**

Econo Bari Saxophone



**STUDENT MODEL
MAJOR BRANDS
(Buescher and Conn)
RANGE TO LOW Bb**

\$1950

No Trades Required

ECONO OVERHAUL JOB INCLUDES:

1. Removal of all major dents & scratches
2. Brass body buffed, polished & relacquered
3. Brass keys buffed & relacquered
4. Nickel keys are chamois buffed to restore shine, minor plating wear & scratches remain
5. Completely repadded with premium pads
6. Entire instrument is cleaned & adjusted
7. All necessary corks, felts & springs are replaced
8. New mouthpiece & deluxe MTS plastic case with recessed wheels

New List \$4500

FREE Deluxe Stand Included

FREE SHIPPING
U.S. Contiguous



Buescher®

C.G. Conn®

Miscellaneous Cornets



Blessing XL-CR Cornet

Beginner Return; used 1 year or less. Minor finish blemishes. Completely cleaned and adjusted. USA Student Model. **Shepherd's Crook**. Clear lacquer finish. Key of Bb. 4.75" Bell. .460" Bore. Monel pistons. Includes new mouthpiece and good used case. List \$1895

10 Payments of \$45

**No Trade Required or
Single Payment of \$450 NT**



Holton C603 Cornet

Beginner Return; used 1 year or less! Minor finish scratches. Completely cleaned and adjusted. Student USA Model with **Shepherd's crook**. Brass finish. .460" Bore. Monel valves. 1st Slide thumb saddle. Includes case and mouthpiece. List \$1310

10 Payments of \$45

**No Trade Required or
Single Payment of \$450 NT**



Holton C555 Cornet

Demo Model; NO Dents! Minor finish scratches. Completely cleaned and adjusted. Intermediate USA Model. Limited 100th Anniversary Edition. 4.75" Rose brass bell with **Shepherd's crook**. Red rose leadpipe. Brass finish with nickel trim. 2 Standard waterkeys. .459" Medium large bore. Monel valves. 1st Slide thumb saddle. Includes case and mouthpiece. List \$NA

10 Payments of \$55

**No Trade Required or
Single Payment of \$550 NT**



Holton C605 Cornet

Econo Overhaul; all major dents and scratches removed. New clear lacquer finish. Completely cleaned and adjusted. Collegiate Student Model. **Shepherd's Crook**. Key of Bb. 4.75" Bell. .460" Bore. Monel pistons. Amado waterkeys. Includes new mouthpiece and case. List \$1410

10 Payments of \$40

**No Trade Required or
Single Payment of \$400 NT**



Holton C602 Cornet

Beginner Return; used 1 year or less! Minor finish scratches. Completely cleaned and adjusted. Student USA Model with Standard Bell. Brass finish. .459" Bore. Monel valves. 1st Slide thumb saddle. Includes case and mouthpiece. List \$1215

10 Payments of \$40

**No Trade Required or
Single Payment of \$400 NT**



King 2220 Cornet

Demo Model; minor finish scratches. Completely cleaned and adjusted. Professional Legend Model. **Shepherd's crook**. Clear Lacquer finish. Key of Bb. British style short model. .462" Bore. 4.75" One-piece, hand crafted rose brass bell. Rose brass leadpipe. Monel pistons. 1st & 3rd slide triggers. Includes King British Style #7 mouthpiece and wood shell case. List \$3251

10 Payments of \$125

**No Trade Required or
Single Payment of \$1250 NT**



Miscellaneous Bb Trumpets



Bach LR180S37 Stradivarius Reverse Trumpet

Demo Model; NO Dents! Minor finish scratches. Completely cleaned and polished. Professional Stradivarius Model. Lightweight body & bell. Standard #37 bell. Reversed construction #25LR mouthpipe. .459 Medium bore. Monel pistons. One-piece Stradivarius style brass valve casing. Brass inside tuning slide. Nickel silver tuning slide receiver. Brass mouthpiece receiver. 1st Valve slide thumb hook. 3rd Valve slide fixed finger ring with adjustable stop mechanism. Includes Bach 7C mouthpiece & deluxe wood shell case. List \$4140

10 Payments of \$245

**No Trade Required or
Single Payment of \$2450 NT**

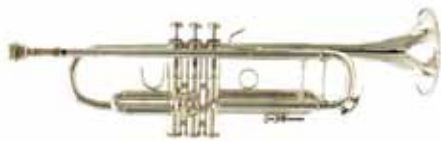

Bach 180S37 Strad Trumpet

Demo Model; NO Dents, minor finish scratches. Completely cleaned and adjusted. Professional Stradivarius Model. Bright silver finish. Standard weight body & bell. Standard construction #25 mouthpipe. Monel pistons. .459" Medium large bore. One piece Stradivarius style brass valve casing. Brass inside tuning slide. Nickel silver tuning slide receiver. Brass mouthpiece receiver. 1st Valve slide thumb hook. 3rd Valve slide fixed finger ring with adjustable stop mechanism. Includes Bach 7C mouthpiece and deluxe wood shell case (minor scuffs on case). List \$3948

10 Payments of \$235

**No Trade Required or
Single Payment of \$2350 NT**



Blessing BTR1270 Trumpet

Beginner Return. Very minor dents and finish scratches. Completely cleaned and adjusted. USA Scholastic Student Model. Key of Bb. .460" Medium large bore. 5" Bell. Clear lacquer finish. 1st Valve slide thumb hook. Adjustable 3rd valve slide finger ring. Monel valves. Nickel trim. Includes mouthpiece and case. List \$875

10 Payments of \$40

**No Trade Required or
Single Payment of \$400 NT**



Bach ITR501S Liberty Trumpet

Demo Model; minor ding in bell flare. Completely cleaned and adjusted. Bach Professional USA Model. Exclusively manufactured for Music & Arts. Built in Elkhart, IN and closely resembles the Bach Stradivarius 180S37 model. Bright silver finish. Monel pistons. 4.75" One piece bell. .459" Medium large bore. 1st Valve slide thumb hook. 3rd Valve slide fixed finger ring with adjustable stop rod. Includes Bach 7C mouthpiece and black Liberty case. List \$NA

10 Payments of \$175

**No Trade Required or
Single Payment of \$1750 NT**

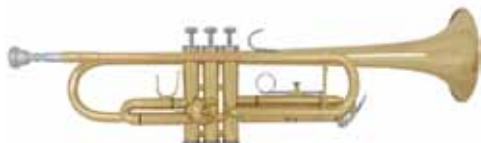

Bach TR300H2 Trumpet

Beginner Return. Very minor finish scratches. No dents! Clean appearance. Completely cleaned and adjusted. Student USA Model. Key of Bb. 4.75" Bell. .459" Bore. Clear Lacquer finish. 1st Slide thumb hook. Monel pistons. Includes hard shell case & mouthpiece. List \$1193

10 Payments of \$50

**No Trade Required or
Single Payment of \$500 NT**



Bach VBS1S Trumpet

Demo Model; No Dents! Minor finish scratches. Completely cleaned and adjusted. Bach Intermediate USA Model. Bright silver finish. 4.75" Two piece bell. .459" Medium bore. Monel pistons. 2 Standard waterkeys. 1st Slide thumb hook. Fixed 3rd slide ring with stop rod. Includes Bach 7C mouthpiece and wood shell case. List \$NA

10 Payments of \$95

**No Trade Required or
Single Payment of \$950 NT**



Miscellaneous C & Piccolo Trumpets



Bach C180SL239W3 'C' Stradivarius Trumpet

New, Discontinued Model configuration!
Professional Stradivarius Key of C Model
One piece #239 bell (produces rich, big, dark sound)
#25R reversed construction mouthpiece is slightly longer than standard #25C (longer form of the 25C; gives it a more open & free blowing with darker sound; additional leadpipe length improves intonation of high register)
.462" Large bore
Bright silver finish
Standard waterkey on main tuning slide
Fixed 3rd slide ring with stop rod
1st Slide thumb saddle; Monel valves
Includes Bach 7C mouthpiece and deluxe Bach wood shell case with brown zippered closure covering.
List \$3895

** We had our local university professor test this instrument. His comments: Big open sound. Great symphony horn.

10 Payments of \$185

**No Trade Required or
Single Payment of \$1850 NT**



Bach C180SL238W736 'C' Stradivarius Trumpet

New, Discontinued Model configuration!
Professional Stradivarius Key of C Model
One piece #238 Vindabona bell (produces a rich sound quality w/slightly different overtone pattern)
Standard #25C leadpipe (offers some resistance & is effective in centering or tying together tone production)
.462" Large bore
Bright silver finish
Standard waterkey on main tuning slide
Fixed 3rd slide ring with stop rod
1st Slide thumb saddle; Monel valves
Includes Bach 7C mouthpiece and deluxe Bach wood shell case with brown zippered closure covering.
List \$4159

** We had our local university professor test this instrument. His comments: Great playing; even in all registers. Great Symphony horn.

10 Payments of \$195

**No Trade Required or
Single Payment of \$1950 NT**



Conn 51B Constellation 'C' Trumpet

Demo Model; minor finish scratches on bell crook. Completely cleaned and adjusted.
Intermediate USA CONNstellation Model
Key of C
Clear lacquer finish
.462" Bore
4 7/8" Seamless bell
Monel pistons
Reverse leadpipe
Rounded main tuning slide crook
Heavy top & bottom valve caps
Patented Modular Valve Weight (MVW) System
Includes 3C mouthpiece and deluxe case
List \$NA

10 Payments of \$85

**No Trade Required or
Single Payment of \$850 NT**



Yamaha YTR8445IIS Xeno 'C' Trumpet

Used, Mint Condition! Used by our local university students for testing & symphony play. Completely cleaned, adjusted & polished.
Professional Key of C Model
Bright silver finish
4 7/8" yellow brass one piece bell
.462" bore
Monel valves
Double braces on main tuning slide
1st Slide thumb saddle
Fixed 3rd slide ring
Includes mouthpiece & case
List \$3578

10 Payments of \$185

**No Trade Required or
Single Payment of \$1850 NT**

Bach VBS196 Piccolo Trumpet

Demo Model; minor finish scratches. Completely cleaned, adjusted and polished.
Professional Vincent Bach Long Piccolo Trumpet
Bright silver finish
Key of Bb/A
4" One-piece hand hammered long bell w/flat rim
.401" Small bore
4 Monel pistons
Bob Reeves valve alignment
Separate mouthpipes for Bb and A
Extra 4th slide for key of G
Includes Bach 7E mouthpiece & leather carrying bag
List \$4406

10 Payments of \$245

**No Trade Required or
Single Payment of \$2450 NT**

DEMO Model Trombones



Bach TB400B F-Attachment Trombone

Demo Models! NO Dents! Minor finish scratches.
Completely cleaned and adjusted.

Imported Bach Intermediate F-Attachment Model

Open Wrap tubing

.547" Large bore

8.5" Rose gold bell

Clear lacquer finish with nickel trim

Nickel silver outer tubing on hand slide

Includes lightweight softshell case & Bach 6 1/2AL mouthpiece

List \$NA

10 Payments of
\$100

No Trade Required or
Single Payment of \$1000 NT

FREE SHIPPING
U.S. Contiguous



JUPITER



Jupiter CTB600 F-Attachment Trombone

Demo Models! These were new instruments from the All American Army Band Clinic used by some of America's finest for a one week clinic and performance. Very minor scuffs & scratches. Completely cleaned and adjusted.

Jupiter Intermediate F-Attachment Trombones
(identical to Jupiter 636RLO)

Open Wrap tubing

Brass finish with nickel trim

.547" large bore

Chrome inner slides

Solid nickel outer slide tubes

Modified open wrap

Direct pull trigger

Tapered rotor bearing shaft with nylon sockets

8.5" Rose brass bell

Includes 6 1/2 AL mouthpiece and case

List \$1800

10 Payments of
\$100

No Trade Required or
Single Payment of \$1000 NT

Econo French Horns

ECONO 3 VALVE Bb FRENCH HORNS



MAJOR BRANDS:

*Olds
Reynolds
Conn
Holton*

JOB INCLUDES:

1. Removal of all major dents & scratches
2. Entire instrument is stripped, buffed, polished & relacquered
3. New corks & felts
4. Completely flushed & chemically cleaned
5. Proper alignment of rotors
6. New case
7. New mouthpiece

New List \$2740

\$495

No Trade Required



FREE SHIPPING

U.S. Contiguous



ECONO F FRENCH HORNS



MAJOR BRANDS:

*Olds
Conn
King
Amati*

JOB INCLUDES:

1. Removal of all major dents & scratches
2. Entire instrument is stripped, buffed, polished & relacquered
3. New corks & felts
4. Completely flushed & chemically cleaned
5. Proper alignment of rotors
6. New case
7. New mouthpiece

New List \$2630

\$595

No Trade Required



ECONO 4 VALVE Bb FRENCH HORNS

4th Rotor Valve is Muting Transposing (to key of 'A') stopping valve useful for advanced students & soloists



*King
Holton*

\$595

No Trade Required

EconoBaritones

ECONO BELL FRONT BARITONES

Major Brands
Three Valve
Bell Front Models

\$795
No Trade Required

JOB INCLUDES:

1. Removal of all major dents & scratches
2. Entire instrument is stripped, buffed, polished & relacquered
3. New corks & felts
4. Completely flushed & chemically cleaned
5. Proper alignment of valves
6. New case
7. New mouthpiece

New List \$2700

MAJOR BRANDS AVAILABLE:
CONN CLEVELAND
KING OLDS
REYNOLDS



FREE SHIPPING

U.S. Contiguous



ECONO UPRIGHT BELL BARITONES

Major Brands
Three Valve
Upright Bell Models

\$995
No Trade Required

JOB INCLUDES:

1. Removal of all major dents & scratches
2. Entire instrument is stripped, buffed, polished & relacquered
3. New corks & felts
4. Completely flushed & chemically cleaned
5. Proper alignment of valves
6. New case
7. New mouthpiece

New List \$2700

MAJOR BRANDS:
CONN 151
OLDS A351
REYNOLDS BR58



Limited Quantities Available!

Intermediate French Horns



HOLTON 

Holton H378 French Horn

Demo Model; minor finish scratches.
Completely cleaned and adjusted.

Intermediate Model
Similar playing characteristics
to those of the "Farkas" H178
Key of Bb/F
Brass lacquered finish
.468" bore
Standard size bell & branch
Holton mouthpiece
Molded plastic case
List \$4601

10 Payments of
\$235

**No Trade Required or
Single Payment of \$2350 NT**

****Limited to our In Stock Supply****

C.G. Conn® Conn 6D French Horn



Demo Model; No Dents! Minor finish scratches.
Completely cleaned and adjusted.

Intermediate Artist Model
Key of F/Bb
.468" Bore
12" Bell
Clear lacquered brass finish with nickel trim
Nickel outer slides
Tapered rotors and bearings
Includes #2 mouthpiece and deluxe hard shell case
List \$4783

10 Payments of
\$245

**No Trade Required or
Single Payment of \$2450 NT**

****Limited to our In Stock Supply****

FREE SHIPPING
U.S. Contiguous



Intermediate Euphonium

Holton B490RS Euphonium

Demo Model; minor finish scratches.
Completely polished, cleaned and adjusted.

Intermediate Collegiate Model

Bright silver finish

4 nickel plated upright action valves

.571" bore

11" upright bell

Includes 6 1/2AL mouthpiece & vinyl case

List \$3263



10 Payments of
\$165

**No Trade Required or
Single Payment of \$1650 NT**



**Upgraded with Deluxe
Taylor 1201 MTS Case**

****Limited to our In Stock Supply****

HOLTON 





York 377 3/4 Size Eb Tuba

Demo; minor dings and finish scratches.
Completely cleaned and adjusted.

German Instruments made by
Schreiber & Keilwerth previously distributed by Buffet.

Brass finish with Nickel trim

Key of Eb

- 16" Upright bell
- 3 Upright action monel valves
- .662" Bore
- 3 Standard waterkeys
- 29.5" Total length
- Includes mouthpiece
& softshell case
with backpack straps

\$750

No Trade Required



York

****Limited to our In Stock Supply****

York 387 3/4 Size Bb Tuba

Demo; minor dings and finish scratches.
Completely cleaned and adjusted.

German Instruments made by
Schreiber & Keilwerth previously distributed by Buffet.

Brass body with Nickel trim

Key of Bb

- 16" Upright bell
- 3 Upright action monel valves
- .662" Bore
- 5 Standard waterkeys
- 30.5" Total length
- Includes mouthpiece & softshell case
with backpack straps

\$1750

No Trade Required

**Your Choice of Finish
Brass or Bright Silver**



York



****Limited to our In Stock Supply****

FREE SHIPPING

U.S. Contiguous



King 1135W 3/4 Size Tuba

Demo Model; minor dent and finish scratches.
Completely cleaned and adjusted.

King 3/4 Size Tubas
Key of BBb
3 Front action valves
14 7/8" Upright bell
Brass finish
.660" Bore
Includes mouthpiece & deluxe vinyl plastic case
with recessed wheels
List \$6714

\$2950

No Trade Required



****Limited to our In Stock Supply****



King 1140W Full Size Tuba

Demo Model; minor dent and finish scratches.
Completely cleaned and adjusted.

Full Size Tubas
Key of BBb
3 Upright action valves
15" Upright bell
Brass finish
.640" Bore
Includes mouthpiece & deluxe vinyl case
with recessed wheels
List \$6854

\$3150

No Trade Required



****Limited to our In Stock Supply****



FREE SHIPPING
U.S. Contiguous



Misc. Baritones/Euphoniums

Conn 51 Euphonium

Econo Overhauled. All major dents and scratches removed. New clear lacquer finish. Completely flushed and chemically cleaned. Intermediate Model. 11" Upright bell. **4 Front action valves.** Nickel plated valves. .560" bore. Includes new mouthpiece and case. List \$NA

\$1250

10 Payments of \$125
No Trade Required

King 625 Baritone

Demo Model; minor finish scratches. Completely cleaned and adjusted. Diplomat Student Model. Clear lacquer finish. 3 Front action valves. 11" Bell front bell. Pull rings on 1st & 2nd slides. Lacquered brass finish. .562" Bore. Includes hard shell case and mouthpiece. List \$2892

\$1350

10 Payments of \$135
No Trade Required

Prelude EP711 Baritone

Beginner Return; minor dents and finish scratches. Completely flushed, ultrasonically cleaned and polished. Prelude Student Model; China origin imported and distributed by Conn-Selmer. Key of Bb. Brass finish with nickel trim. Red brass leadpipe. 11" Upright bell. 3 Upright action valves. .571" Bore. 2 Standard waterkeys. Bass shank receiver. 26" Total length. Includes Bach 6 1/2AL mouthpiece and lightweight softshell case. List \$NA

\$750

10 Payments of \$75
No Trade Required

Deg 823L Junior Baritone

Beginner Return! Minor dents and finish scratches. Completely flushed and chemically cleaned. Student Junior Model. Key of Bb. 10" Upright bell. 3 Upright action valves. Nickel plated valves. .570" bore. 3 Standard waterkeys. 23" Total length. Includes new mouthpiece and case. List \$1595

\$850

10 Payments of \$85
No Trade Required

King 625SB Baritone

Demo Model; small blemish on outside of bell. Completely cleaned and adjusted. Diplomat Student Model. **Satin Silver finish with Bright Silver plated trim.** 3 Front action valves. 11" Bell front bell. Pull rings on 1st & 2nd slides. Lacquered brass finish. .562" Bore. Includes hard shell case and mouthpiece. List \$3352

\$1450

10 Payments of \$145
No Trade Required

Yamaha YEP321 Euphonium

Demo; minor bell crease from shipping. Completely cleaned and polished. Yamaha Intermediate Model. Clear lacquer finish. **4 Upright nickel plated valves.** 11" upright bell. .571" bore. Includes case and mouthpiece. List \$3408

\$1850

10 Payments of \$185
No Trade Required

Getzen Junior Baritone

Econo Overhauled. All major dents and scratches removed. New clear lacquer finish. Completely flushed and chemically cleaned. USA Student Junior Model. Key of Bb. 10" Upright bell. 3 Upright action valves. Nickel plated valves. 3 Amado waterkeys. .565" bore. Includes new mouthpiece and case. List \$NA

\$750

10 Payments of \$75
No Trade Required

King 627 Baritone

Demo Model; minor finish scratches on bell stem on bottom bow. Diplomat Student Model. Clear lacquer finish. 3 Front action valves. 11" Upright bell. Lacquered brass finish. .562" Bore. Includes hard shell case and mouthpiece. List \$2892

\$1450

10 Payments of \$145
No Trade Required

Yamaha YEP842S Pro Compensating Euphonium

Used, Mint Condition! NO Dents! Minor finish scratches. One owner. Completely flushed, ultra sonic cleaning and polished. **Bright silver finish with gold plated trim.** Hand hammered yellow brass bell features an advanced taper design. Open Design, Non-corrosive gold brass leadpipe. Improved bracing and holding tube. Nickel silver slide tubing. Key of Bb/F. 3 Top action; 4th Side action monel pistons. .591"-.661" Bore. 11.8" Upright two piece bell. Large shank mouthpiece receiver. Includes original case and Yamaha 53HC bass shank mouthpiece. List \$10,707

\$4950

10 Payments of \$495
No Trade Required

Holton B480R Baritone

Demo Model; minor finish scratches. NO Dents! Completely cleaned and polished. Student Collegiate Model. Clear lacquer finish. 3 Upright action valves. .571" bore. 11" upright bell. Includes 6 1/2AL mouthpiece & vinyl case. List \$2569

\$1250

10 Payments of \$125
No Trade Required

King 628 Baritone

Demo Model; minor finish scratches. **Ergonomically designed Student Model.** Clear lacquer finish. .580" Bore. 11" Upright bell. 3 Top action valves, nickel plated pistons. Includes 6 1/2AL small shank mouthpiece &, hardshell case. List \$3294

\$1650

10 Payments of \$165
No Trade Required



No Trades Required!



FREE SHIPPING
U.S. Contiguous
ON ACCESSORY
ORDERS OVER
\$75

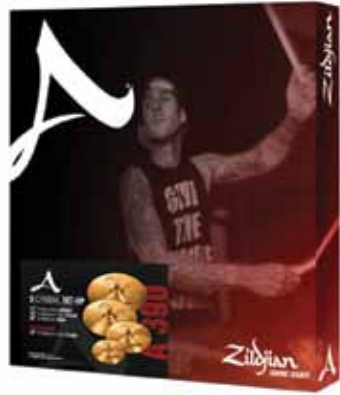

ZBT Starter Package

ZBTS3P - Zildjian's Bronze Technology, offers great sounding, bright and focused cymbals. Perfect for beginners looking for a great sound at a low price! List \$462

Package Includes:

- 1 Pr. 13" Hi Hats
- 1 Ea. 18" Crash Ride
- *Added Value*
- 1 Ea. 14" Crash

***\$189⁹⁵**
PACKAGE

A. Zildjian Package

A390 - The standard by which all other cymbals are judged. Cymbals have a spectrum of tonal colors with a powerful, full bodied sound. List \$1825

Package Includes:

- 14" New Beat Hi-Hats, Pair
- 16" Thin Crash, Each
- 20" Medium Ride, Each
- *Added Value*
- 18" Med Thin Crash, Each

***\$679⁹⁵**
PACKAGE



ZHT Pro Package

ZHT390 - Zildjian's Superior Sheet Bronze Cymbals offers more distinct models than any previous Zildjian sheet bronze selection. Each reflects unique lathing lines and distinctive hammering patterns designed to accentuate their sound properties. Cymbals are fast, bold, bright, and powerful. List \$1015

Package Includes:

- 14" Hi-Hats, Pair
- 16" Medium Thin Crash, Each
- 20" Medium Ride, Each

***\$369⁹⁵**
PACKAGE



TM24/7 Drum Throne

TTH1 Chrome plated, heavy duty double braced legs. Adjustable height-turn & lock position. Thick padded saddle style seat. Top covered with black plush velvet material & leatherette side covering. List \$148

\$85



Pearl Drum Throne

D790 Thickly padded round vinyl covered cushion, die cast seat bracket for security and durability. Double braced legs with rubber grip feet. Stoplock height adjustments: 16.9" to 25.6" List \$119

\$75



Pearl Roadster Drum Throne

D1000SPN Double Braced with Shock Absorber. Designed for maximum comfort. Provides a radical shock absorber that will add energy to every movement. List \$299

\$149

Zildjian





*Cymbals and Throne Sold Separately



Pearl Vision Birch VB925 Drum Set

VB Vision Birch Series Drum Sets
Complete 5 piece drum set with hardware

Beautiful High Gloss Arctic Sparkle Wraped Finish

- 6 Ply 7.5mm Toms
- 100% Birch shells
- Matching Birch ply Snare Drum
- Wood bass drum hoops with matching finish
- Remo Snare Drum heads
- Remo Clear Tom heads
- Remo Powerstroke heads
- I.S.S. Tom Mounting System
- Reference-Look bridge lugs w/rubber gaskets
- Reference-Look Recessed bass drum claws w/Rubber lining
- Bridge type bass bracket
- Uni-lock tom holders
- 930 Series Hardware
- List \$1529

(Cymbals Sold Separately)

Set Includes:

- 1 - 18x22 Bass Drum
- 1 - 16x16 Floor Tom
- 1 - 9x12 Power Tom
- 1 - 10x13 Power Tom
- 1 - 5.5x14 Matching Snare Drum
- 1 - S930 Snare Stand
- 1 - C930 Cymbal Stand
- 1 - B930 Boom Cymbal Stand
- 1 - H930 Hi-Hat Cymbal Stand
- 1 - P930 Foot Pedal
- 2 - TH88I Tom Holders

\$550

Call For Shipping Cost



*Cymbals and Throne Sold Separately



Pearl Vision Birch VBL925 Drum Set

VBL Vision Birch Series Drum Sets
Complete 5 piece drum set with hardware

Beautiful Super High Gloss Graphite lacquer finish
****Discontinued Color****

- 6 Ply 7.5mm Toms
- 8 Ply 10MM Bass & Floor Tom
- 100% Birch shells
- Steel SensiTone Snare Drum with Chrome finish
- Wood bass drum hoops with matching finish
- Two-Ply tom batter heads
- Perimeter EQ bass drum heads with 3.5" wide rings
- I.S.S. Tom Mounting System
- Reference-Look bridge lugs w/rubber gaskets
- Reference-Look Recessed bass drum claws w/Rubber lining
- Bridge type bass bracket
- Uni-lock tom holders
- 930 Series Hardware
- List \$1899

(Cymbals Sold Separately)

Set Includes:

- 1 - 18x22 Bass Drum
- 1 - 16x16 Floor Tom
- 1 - 8x10 Power Tom
- 1 - 9x12 Power Tom
- 1 - 5.5x14 Steel SensiTone Snare Drum
- 1 - S930 Snare Stand
- 1 - C930 Cymbal Stand
- 1 - B930 Boom Cymbal Stand
- 1 - H930 Hi-Hat Cymbal Stand
- 1 - P930 Foot Pedal
- 2 - TH900I Tom Holders

\$650

Call For Shipping Cost

****Limited to our In Stock Supply****

**Midwest Show Sabian Display Samples
May have scratches, dings and not in original packaging.**

Sabian Triangles

Crafted from pure B8 cymbal alloy (8% tin, 92% copper with traces of silver) to produce bright, shimmering sounds with ample sustain.

B8 Bronze Triangles

Model	Description	List	Sale
61134-4B8	4" B8 Bronze Triangle	\$56	\$28
61134-8B8	8" B8 Bronze Triangle	\$84	\$39
61134-10B8	10" B8 Bronze Triangle	\$99	\$47

Hand Hammered B8 Bronze Triangles

Model	Description	List	Sale
61135-4B8H	4" HH B8 Bronze Triangle	\$112	\$52
61135-6B8H	6" HH B8 Bronze Triangle	\$126	\$60
61135-7B8H	7" HH B8 Bronze Triangle	\$133	\$63
61135-8B8H	8" HH B8 Bronze Triangle	\$140	\$68
61135-9B8H	9" HH B8 Bronze Triangle	\$147	\$71
61135-10B8H	10" HH B8 Bronze Triangle	\$153	\$76

Sabian High & Low Octave Crotales

Full Octave sets include universal mounting bar to fit cymbal stand. 13 tuned discs made of B20 bronze. Tuned to A+442. Medium heavy weight. List \$2935 per Set

Options:

- 50303H High Pitch Set
- 50303L Low Pitch Set

\$1195 Per Set



Sabian Triangle Accessories

Model	Description	Sale
61122	Triangle Clip	\$12
61140-4	4" Black Zippered Triangle Bag	\$10
61140-6	6" Black Zippered Triangle Bag	\$12
61140-8	8" Black Zippered Triangle Bag	\$14



Sabian Mallets

Model	Description	List	Sale
61124	Hard Cymbal Mallets, Pair	\$64.50	\$39
61125	Soft Cymbal Mallets, Pair	\$71.95	\$45
61126	Fortissimo Crotales Mallets, Pair	\$33.50	\$22
61004S	Small Gong Mallet, Each	\$76.50	\$46



Sabian Practice Pads

Quiet Tone Classic - Special sound absorbing mesh reduces volume up to 90%. Real drumhead delivers authentic feel for sticking & brushwork. Triple flanged metal hoop is ideal for rim shots & cross sticking. Adjustable tensioning. Patented non-slip rubber feet. List \$58-\$72

- QT-10SD 10" **\$32**
- QT-14SD 14" **\$39**



FREE SHIPPING
U.S. Contiguous
ON ACCESSORY
ORDERS OVER
\$75

**Midwest Show Sabian Display Samples
May have scratches, dings and not in original packaging.**

****Limited to our In Stock Supply****

Sabian HHX Series

Model	Description	List	Sale
11894XBH	18" Synergy Heavy, Pair Natural Finish. Heavy weight. Dark sound.	\$1068	\$455
11794XBM	17" Synergy Medium, Pair Natural Finish. Medium weight. Dark sound.	\$988	\$425
12094XBM	20" Synergy Medium, Pair Natural Finish. Medium weight. Dark sound.	\$1228	\$495
11723XN	17" Suspended, Each Natural Finish. Thin weight. Dark sound.	\$494	\$225
11823XB	18" Suspended, Each Brilliant Finish. Thin weight. Dark sound.	\$534	\$245



Sabian Artisan Series

Model	Description	List	Sale
A1855	18" Traditional Symphonic, Pair Natural Finish. Medium heavy. Dark sound.	\$1440	\$575
A1856	18" Traditional Symphonic, Pair Natural Finish. Medium light. Dark sound.	\$1440	\$575
A1855F	18" Forza, Pair Natural Finish. Heavy weight. Dark sound.	\$1440	\$575



Sabian AAX Series

Model	Description	List	Sale
21723X	17" Suspended Orchestral, Each Natural Finish. Med thin weight. Bright sound.	\$364	\$175
21822XB	18" Arena Medium, Pair Brilliant finish. Medium weight. Bright sound.	\$792	\$365



Sabian AA Series

Model	Description	List	Sale
21820	18" Viennese, Pair Natural finish. Medium weight. Bright Sound.	\$792	\$345
21822	18" Marching Band, Pair Natural finish. Med heavy weight. Bright sound.	\$792	\$345
21889	18" Molta Symphonic Suspended, Each Natural finish. Thin weight. Bright sound.	\$396	\$175



Sabian HH Series

Model	Description	List	Sale
11820	18" Viennese, Pair Natural finish. Medium weight. Dark Sound.	\$1068	\$455
11823	18" Suspended, Each Natural finish. Thin weight. Dark sound.	\$534	\$245



Sabian XS20 Series

Model	Description	List	Sale
XS1621	16" Concert Band, Pair Natural finish. Medium weight. Bright Sound.	\$436	\$195





Musser M645 Classic Orchestra Bells

Demo Model; minor nicks and scuffs.
Completely cleaned and adjusted.
2.5 Octaves
Steel bars are nickel plated with satin finish
Non-graduated bars
Includes pair of mallets and wood shell case
Pitch: A442
Range: G5 - C8
Length: 32"
Width: Low End 21", High End 11"
Weight: 43 lbs
List \$1855

\$888



Slingerland Deagan 1576 Orchestra Bells

Used, good condition. Bars show marks from use.
Completely cleaned and adjusted.
2.5 Octave
G-C Range
Steel bars with nickel plating
Bars 1 1/4" wide; 5/16" thick
Includes new vinyl covered wood case with
removable lid, carrying handle & pair of mallets
List \$NA

\$588



Musser M665B Symphonic Chimes

Demo Model; Store Display. Like new condition.
Completely cleaned and polished.
Symphonic Model with Concert Frame
1.5 Octaves
Gold vein powder coated frame
Satin finished brass tubes
1.5" tube diameter
Self-equalizing pressure damper
Includes rawhide chime mallet & detachable mallet holder
Range: C5 - G6
Pitch: A442
Height: 70"
Width: 34"
Weight: 220 lbs
List \$8414

\$3888





Musser M66 Marching Xylophone with Keyboard Cart

Used, Good condition! Bars and frame shows minor finish wear. Completely cleaned and adjusted.
2.5 Octave
C5-G7 Range; A442 Tuning
Non-graduated kelson bars; 1.5" wide, 7/8" thick
Silver resonators
Includes New M8005 Keyboard Cart with 5" casters
Includes pair of mallets
List \$2610

\$888



Musser M8067 Marching Xylophone with Keyboard Cart

Used, Good condition! Bars and frame shows minor finish wear. Completely cleaned and adjusted.
2.5 Octave
C5-G7 Range; A440 Tuning
Non-graduated kelson bars; 1.5" wide, 7/8" thick
Silver resonators
Includes New M8005 Keyboard Cart with 5" casters
List \$2610

\$888



Musser M39 Piccolo Xylophone

Demo Model; excellent condition. Bars show very minor usage marks. Completely cleaned and polished. Excellent for school music departments. Mounted in vinyl covered wood shell case with detachable lid and carrying handle.
Kelson bars
3 Octaves
Supplied with mallets
Frame is sold separately
Range: C5 - C8
Pitch: A442
Bars: Non-graduated
Length: 45"
Width: 24.5" low end, 12.5" high end
Weight: 50 lbs
List \$2304

\$888



MUSSER MALLET INSTRUMENTS



Shown with
LFP 302BKS Bell Stand
Add \$95



Shown with M8005 Moto-Cart
Add \$385



Shown with
LE1368 Bell Stand
Add \$85

MUSSER M645 ORCHESTRA BELLS

New!
Steel Orchestra Bells
with satin-finish
2.5 octaves
Note range: G5 - C8
Tuned to A-442
Non graduated bars
Mounted in wood case
with detachable lid
Depth: 3.5"
Length: 32"
Width: 21" low end,
11" high end
Weight: 43 lbs.
Includes mallets
List \$1930

SALE \$ 975

MUSSER M646 ORCHESTRA BELLS WITH HAND DAMPER

New!
Steel Orchestra Bells
with satin-finish
2.5 octaves
Hand damper mechanism
for extra control
Note range: G5 - C8
Tuned to A-442
Non graduated bars
Mounted in wood case
with detachable lid
Depth: 3.5"
Length: 31"
Width: 21" low end,
10.5" high end
Weight: 44 lbs
Includes mallets
List \$2455

SALE \$ 1225

MUSSER M656 ORCHESTRA BELLS

New!
Aluminum Orchestra Bells
2.5 octaves
Note range: G5 - C8
Tuned to A-442
Non graduated bars
Mounted in wood case
Depth: 3.5"
Length: 32"
Width: 21" low end,
11" high end
Weight: 29 lbs.
Includes mallets
List \$1300

SALE \$ 675



**ADD M8005 Moto-Cart
for M645 or M646**

\$385



MAJESTIC PERCUSSION



MAJESTIC ORCHESTRA BELLS

(Distributed by Jupiter)

2.5 Octaves
3/8" Thick bars, 1.25" Bar width
Includes mallets and hard shell, deep case
Range: G5-C8
Length: 31.98"
Width: 19.89"
Weight: 45.10 lbs

Majestic B3525A Orchestra Bells w/Aluminum Bells

List \$1095

Sale \$625

Majestic B3525S Orchestra Bells w/Steel Bells

List \$1600

Sale \$885

Stand Option:



TM24/7 Folding Stand \$45



majestic

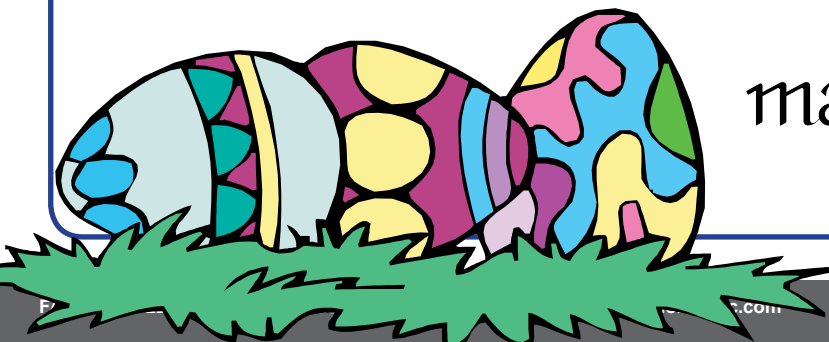

MUSSER MALLET INSTRUMENTS



MUSSEY

MUSSER M51 XYLOPHONE

New!
Portable Xylophone
Kelon bars
Full 3.5 octaves
Detachable resonators
Folding legs for easy transport
Range: F4 - C8
Pitch: A-442
Bars: non-graduated
Height: 32" - 36"
Length: 53.5"
Width: 30.5" low end, 11.5" high end
Weight: 100 lbs.
Supplied with mallets & shallow drop cover
List \$4223



SALE \$ 2155



MUSSER M50 XYLOPHONE

New!
Portable Xylophone
Select rosewood bars
Full 3.5 octaves
Detachable resonators
Folding legs for easy transport
Range: F4 - C8
Pitch: A-442
Bars: non-graduated
Height: 32" - 36"
Length: 53.5"
Width: 30.5" low end, 11.5" high end
Weight: 100 lbs.
Supplied with mallets & shallow drop cover
List \$7187

SALE \$ 3655



MAJESTIC PERCUSSION



MAJESTIC X6535P XYLOPHONE (Distributed by Jupiter)

- 3.5 Octave
- Synthetic bars**
- Precision quint tuning
- Full slant resonators with gold finish
- Concert frame
- Crank up height adjustment
- Range: F4-C8
- Length: 61.23"
- Width: 27.30"
- Height: Crank (35.10" - 44.85")
- List \$3300

Sale \$1725



MAJESTIC X6540P XYLOPHONE (Distributed by Jupiter)

- 4 Octave
- Synthetic bars**
- Precision quint tuning
- Full slant resonators with gold finish
- Concert frame
- Crank up height adjustment
- Range: C4-C8
- Length: 66.30"
- Width: 27.30"
- Height: Crank (35.10" - 44.85")
- Weight: 182 lbs
- List \$4815

Sale \$2725

majestic

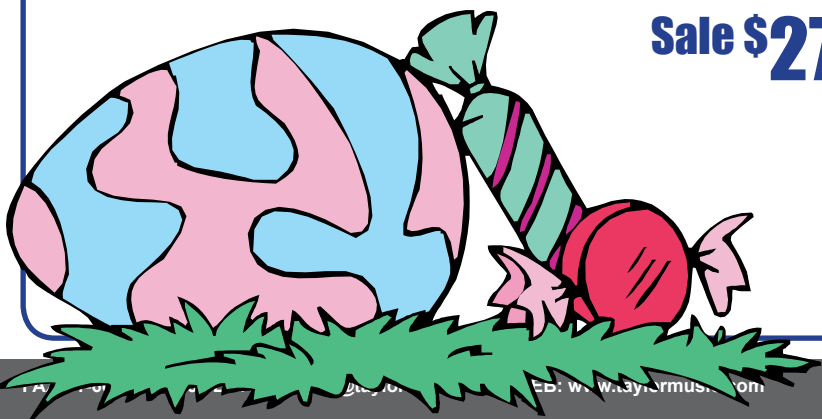



MUSSER M44 VIBRAPHONE

New!
 Combo Vibe
 Satin silver finished bars & resonators
 3 octaves
 Tension adjustable damper bar
 Folding legs for easy transport
Single speed motor
 Range: F3 - F6
 Pitch: A-442
 Bars: Non-graduated
 Height: 32" - 36"
 Length: 42"
 Width: 28" low end, 15.5" high end
 Weight: 75 lbs.
 Includes mallets
 List \$5050



SALE \$ 2555



MUSSER M48 VIBRAPHONE

New!
 Pro Traveler Vibe
 Gold satin finished wide graduated bars
 3 octaves
Multi-speed motor
 Range: F3 - F6
 Pitch: A-442
 Height: 35.5"
 Length: 56"
 Width: 29" low end, 15" high end
 Weight: 140 lbs
 Locking wheel casters on frame
 Includes mallets & shallow drop cover
 List \$9922

SALE \$ 4995



MUSSER M55 VIBRAPHONE

New!
 Pro Vibe
 Silver satin finished bars and resonators
 3 octaves
 Note range: F3 - F6
 Pitch A-442
 Wide graduated bars
Multi-speed motor
 Height: 32" - 36"
 Length: 56"
 Width: 30" low end, 15.5" high end
 Weight: 137 lbs
 Adjustable damper bar
 Deluxe frame with locking wheel casters
 Includes mallets & shallow drop cover
 List \$8669

SALE \$ 4375



MUSSER M75 VIBRAPHONE

New!
 Century Vibe
 Gold finished bars & resonators
 3 octaves
 Pitch A-442
 Wide graduated bars
Variable speed motor
 Range: F3 - F6
 Height: 34.75"
 Length: 56.5"
 Width: 30" low end, 15.5" high end
 Weight: 175 lbs
 Extra wide sustain pedal
 Deluxe frame with solid wood end panels and 4" locking wheels
 Includes mallets & shallow drop cover
 List \$10,307

SALE \$ 5155

MAJESTIC PERCUSSION



MAJESTIC V6530S VIBRAPHONE (Distributed by Jupiter)

Intermediate Model with Motor
3 Octaves

Silver finish aluminum bars
with 2 graduations

Variable speed motor

Crank up height adjustment
Wide pedal with twin pull rods
Offset arch resonators
Memory gel damper pad

Includes cover and mallets

Range: F3-F6

Length: 55.96"

Width: 27.69"

Height: Crank (35.10" - 44.85")

Weight: 156

List \$4765

Sale \$2685

MAJESTIC V7530S VIBRAPHONE (Distributed by Jupiter)

Intermediate Model with Motor
3 Octaves

Silver finish aluminum bars
with 4 graduations

Variable speed motor

Crank up height adjustment
Wide pedal with twin pull rods
Offset arch resonators
Memory gel damper pad

Includes cover and mallets

Range: F3-F6

Length: 63.96"

Width: 30.42"

Height: Crank (35.10" - 44.85")

Weight: 186

List \$6550

Sale \$3495

majestic



MUSSER MALLET INSTRUMENTS

MUSSER M240 MARIMBA



SALE \$ 3675

New!
Studio Grand Model with Concert Frame
A2-C7 note range
4.3 octaves
Triple-tuned Paduk bars
Arched resonators are drawn seamless aluminum, individually hand tuned & finished in silver vein powder coat
Wide graduating bars
Pitch: A-442
Height 35"
Length 81.5"
Weight 170 lbs.
Includes mallets & shallow drop cover
List \$7202



MUSSER M300 MARIMBA

New!
Classic Grand Model with Concert Frame
4.3 octaves
A2 - C7 note range
Kelon bars
Arched resonators are drawn seamless aluminum, individually hand tuned & finished in gold lacquer.
Wide graduating bars
Pitch A-442
Height 36.5"
Length 82"
Weight 218 lbs.
Includes mallets & shallow drop cover
List \$7280

SALE \$ 3695

MUSSER

MUSSER M360 MARIMBA

New!
Classic Grand Model
with **Moto Cart Frame**
4.3 octaves
A2 - C7 note range
Kelon bars
Arched Resonators in drawn seamless aluminum, individually hand tuned & finished in silver vein powder coat
Wide graduating bars
Pitch A-442
Height 36.5"
Length 81"
Weight 265 lbs.
Includes mallets & shallow drop cover
List \$8476

SALE \$ 4295

MAJESTIC PERCUSSION



MAJESTIC M6540P MARIMBA (Distributed by Jupiter)

Intermediate Model with Synthetic bars
 4 Octaves
 3 graduations
 Offset arch resonators with gold finish
 Crank up height adjustment
 Range: 4 Octaves, C3-C7
Bars: Synthetic
 Resonators: Offset Arch
 Length: 87.36"
 Width: 30.42"
 Height: Crank; 35.10" - 44.85"
 List \$4900



MAJESTIC M6543P MARIMBA (Distributed by Jupiter)

Intermediate Model with Synthetic bars
 4.3 Octaves
 5 graduations
 Offset arch resonators with gold finish
 Crank up height adjustment
 Range: 4.3 Octaves, A2-C7
Bars: Synthetic
 Resonators: Offset Arch
 Length: 88.53"
 Width: 35.10"
 Height: Crank; 35.10" - 44.85"
 List \$6550

Sale \$3555

majestic

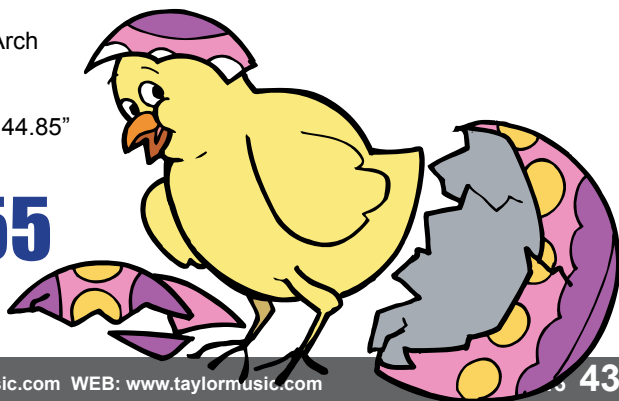



MUSSER M635B CHIMES

New!
 Classic Model
 1.5 Octaves
 Gold frame and **Brass** finished tubes
1 1/4" tube diameter
 Pitch: A-442
 Weight 160 lbs.
 Note range C5 - G6
 Width 33"
 Height 66"
 Includes rawhide chime mallet &
 detachable mallet holder
 List \$6225

SALE \$ 3175

**Optional Moto Cart Frame
 No Additional Charge
 (Specify your choice when ordering)**

MUSSER M635C CHIMES

New!
 Classic Model
 1.5 Octaves
 Silver frame and **Chrome** finished tubes
1 1/4" tube diameter
 Pitch: A-442
 Weight 160 lbs.
 Note range C5 - G6
 Width 33"
 Height 66"
 Includes rawhide chime mallet &
 detachable mallet holder
 List \$7093

SALE \$ 3595

**Optional Moto Cart Frame
 No Additional Charge
 (Specify your choice when ordering)**

MUSSER M665B CHIMES

New!
 Symphonic Model
 1.5 Octaves
 Pitch: A-442
 Gold frame & **brass** finished tubes
1 1/2" tube diameter
 Self-equalizing pressure damper
 Weight 220 lbs.
 Note range C5 - G6
 Width 34"
 Height 70"
 Complete with rawhide chime mallet &
 detachable mallet holder
 List \$8414

SALE \$ 4255

MUSSER M661C CHIMES

New!
 Symphonic Model
 1.5 Octaves
 Pitch: A-442
 Silver frame & **chrome** plated tubes
1 1/2" tube diameter
 Self-equalizing pressure damper
 Weight 200 lbs.
 Note range C5 - G6
 Width 34"
 Height 70"
 Complete with rawhide chime mallet &
 detachable mallet holder
 List \$9766

SALE \$ 4955



MAJESTIC PERCUSSION



MAJESTIC C6518B CHIMES

(Distributed by Jupiter)

18 Note Chimes

1.25" Brass Tubes

1.5 Octaves

Enclosed damper box

Heavy duty die cast Concert frame

Range: C5-F6

Includes cover and mallets

List \$5300

Sale \$2855

MAJESTIC C6618B CHIMES

(Distributed by Jupiter)

18 Note Chimes

1.5" Brass Tubes

1.5 Octaves

Enclosed damper box

Heavy duty die cast Concert frame

Range: C5-F6

Includes cover and mallets

List \$6695

Sale \$3725

majestic



Ludwig Concert Bass



Shown with LE788 Stand
(Not Included)



ludwig[®]

Six-ply rock maple &
American whitewood shell
Shells are die-molded and
cross-laminated
Triple chrome plated
self-aligning lugs
All wood hoops
Complete with
Remo Fiberskyn heads

CORTEX FINISHES AVAILABLE:

White Cortex
Black Cortex
Red Cortex
Mahogany Cortex

CLEAR WOOD FINISHES AVAILABLE:

Cherry Stain
Mahogany
Maple (add \$125)

SIZES	LIST	SALE
14" x 28"	\$1134	\$595
16" x 32"	\$1384	\$725
16" x 36"	\$1477	\$775

SIZES	LIST	SALE
18" x 36"	\$1508	\$795
20" x 36"	\$1524	\$805
18" x 40"	\$2033	\$1055

FOLDING STAND
Model LE790:
Fits 28" to 36" Basses
Drum rests on pads.
List \$164

SALE \$115

**ALL-TERRAIN
TILTING STAND**
Model LE787:
Fits 28" to 40" Basses
Side mounted brackets.
List \$885

SALE \$485

ALL-TERRAIN STAND
Model LE788:
Fits 32" to 40" Basses
Free-Floating suspended by
webbed rings.
List \$1050

SALE \$585

MAPEX PERCUSSION



Price Includes
Tilting Bass Stand

MAPEX CONCERT BASS DRUMS

(Distributed by Jupiter)

- 7.2mm birch shell
- Black wood grain covering
- Black Aluminum hoops
- Square head screw with nylon washer tension rods
- Full length Tube-style lugs
- Remo Fiberskyn3 heads
- Includes Tilting Bass Stand**



Available In Black Wood Grain Covering Only

Model	Size	List	Sale
CBD2816TS	16 x 28	\$1640	\$895
CBD3218TS	18 x 32	\$1910	\$1025
CBD3618TS	18 x 36	\$2070	\$1115
CBD3622TS	22 x 36	\$2140	\$1155
CBD4018TS	18 x 40	\$2420	\$1285



Ludwig Timpani



Ludwig[®]

LUDWIG STANDARD TIMPANI

Standard Model

Deep drawn kettles

Balanced action floor pedal

Steel counter hoop, with six support struts & rods to assure accurate tuning & head pressure

All-directional roller wheels

Each drum includes shallow drop vinyl cover

SET OF 2 Standard Fiberglass

Sizes: 26" & 29"

Model LKS402F

List \$5486

\$2795

SET OF 2 Standard Copper

Sizes: 26" & 29"

Model LKS402P

List \$8201

\$4195

SET OF 4 Standard Fiberglass

Sizes: 23", 26", 29", 32"

Model LKS404F

List \$11,035

\$5655

SET OF 4 Standard Copper

Sizes: 23", 26", 29", 32"

Model LKS404P

List \$16,583

\$8455

Optional Tuning Gauges:

Professional
Tuning Gauges

ADD \$255 Each



Standard
Tuning Gauges

ADD \$175 Each



Trades Accepted
**Call us for your
trade information
and allowance**



Ludwig Timpani

LUDWIG PROFESSIONAL COPPER TIMPANI

Professional Model

Deep drawn copper kettles

Double ring suspension system

Profile collar that extends the head beyond the kettle edge for greater resonance and pitch definition.

Balanced action floor pedal

Six struts & rods to assure accurate tuning and head pressure

Includes Professional Tuning Gauges and Shallow drop covers

Ludwig[®]



Features The Suspended Kettle

The complete tuning mechanism is located outside the kettle. This, combined with the double-ring suspension system, produces a totally undisturbed, undistorted tone and superlative resonance.

SET OF 4 PROFESSIONAL COPPER

Sizes: 23", 26", 29", 32"

Model LKP504PG

List \$20,283

\$10,355

SET OF 2 PROFESSIONAL COPPER

Sizes: 26" & 29"

Model LKP502PG

List \$10,139

\$5175

Out with the old?

(Timpani Trade Allowances)

SETS OF 4 TRADES: (Must be Matched Sets)

Copper, Pedal Tuned w/Struts	\$1200
Fiberglass, Pedal Tuned w/Struts	\$1000
Copper or Fiberglass Pedal Tuned, No Struts	\$600

SETS OF 2 TRADES: (Must be Matched Sets)

Copper, Pedal Tuned w/Struts	\$500
Fiberglass, Pedal Tuned w/Struts	\$400
Copper or Fiberglass Pedal Tuned, No Struts	\$300



MAJESTIC PERCUSSION



MAJESTIC SYMPHONIC TIMPANI

(Distributed by Jupiter)

Majestic Symphonic Series Timpani
 High Quality Series for all levels of players and budgets
 Cast frame features double locking wheels, balance style pedal system
 Includes Remo Renaissance heads, timpani covers & mallets

Options:

- MFP-AP Fiberglass bowls
- MP-A Copper bowls (*shown*)
- MP-AH Hammered Copper bowls

FIBERGLASS SYMPHONIC TIMPANI
 (FRP) Fiberglass Reinforced Polyester kettles

MPF02AP Set of 2
 26" & 29"
 List \$5960

Sale \$3355

MPF04AP Set of 4
 23", 26", 29", 32"
 List \$11,875

Sale \$6695

MPF05AP Set of 5
 20", 23", 26", 29", 32"
 List \$14,655

Sale \$8275

COPPER SYMPHONIC TIMPANI
 Polished finish Parabolic copper kettles

MP02A Set of 2
 26" & 29"
 List \$9105

Sale \$5145

MP04A Set of 4
 23", 26", 29", 32"
 List \$18,205

Sale \$9995

MP05A Set of 5
 20", 23", 26", 29", 32"
 List \$22,455

Sale \$12,325

HAMMERED COPPER SYMPHONIC TIMPANI
 Precision Hammered finish, Parabolic copper kettles

MP02AH Set of 2
 26" & 29"
 List \$10,790

Sale \$5975

MP04AH Set of 4
 23", 26", 29", 32"
 List \$21,565

Sale \$11,955

MP05AH Set of 5
 20", 23", 26", 29", 32"
 List \$26,115

Sale \$14,275

majestic



Bargain Cave Closeouts



Selmer Paris Reference Tenor Sax Case

Demo Model! These are new cases but were downgraded to demo status as they have minor nicks and scratches on top side of case. Designed for Reference 74, 74F, 84, 84F Models. Lightweight. Soft plush interior will fit all Paris tenors including VI, VII, Super 80, 54, 64 Models. Black rigid shell has zipper closure. Detachable shoulder strap. List \$925

~~\$925~~ **\$245**



William Lewis WL2518 16 1/2" Viola

Beginner Return Models; minor nicks & finish scratches. 16 1/2" Violas fits Arm Length of 27 1/4" & Above. Student Orchestra Model. Distributed by Conn-Selmer; European Craftsmanship. Carved spruce top; solid maple back and ribs. Inlaid purfling. Ebony pegs, tailpiece and fingerboard. Includes vinyl case & horsehair bow. List \$NA

~~\$600~~ **\$345**



Long Ranger PA Case

CCPro Molded carrying case for the Long Ranger is air and water tight.

~~\$225~~ **\$155**

Sabian Gong Stand

61005 - Fits 22" to 34". Enameled metal stand; dismantles for travel. List \$276.50

~~\$175~~ **\$175**



MegaVox Pro Dual Deluxe PA System Package

MEGA7501U2 Unit with 1 Wireless Receiver
MEGA8001 Companion Speaker
SC50 Connection Cable
2) SS550 Heavy Duty Speaker Stands
WB6000 Body Pack Transmitter
2) HBM-TA4F Headset Mics
List \$2601

~~\$1680~~ **\$1555**



Sabian Gooseneck Cymbal Attachment

61111NP Unique geometric design; an ergonomic alternative to traditional goosenecks. Multi-level base to fit any stand. List \$85

~~\$85~~ **\$55**



Invader Darkmatter Practice Pad

Made by OffWorld Percussion. 360 degree, stick saving rim element for producing rim shot effects. Newly formulated space age synthetic playing surface. Encased in specially formulated high impact with non-slip base. Fits perfectly on any 14" snare or snare stand.

V3-Blk Black Rim **\$45**
V3-Red Red Rim

Pearl Shekere

PSK10 Lightweight fiberglass body with adjustable bead netting. List \$199

~~\$199~~ **\$75**



Ludwig Low Range Concert Toms

Used, Excellent Condition!
Finish: **White Cortex**
Sizes: 13", 14", 15", 16"
4 Low Range Concert Toms
w/2 LM442TSR Tom Stands
Includes new heads
List \$1945

~~\$555~~ **\$444**



Ludwig Low Range Concert Toms

Used, Excellent Condition!
Finish: **Natural Mahogany Stain**
Sizes: 13", 14", 15", 16"
4 Low Range Concert Toms
w/2 LM442TSR Tom Stands
Includes new heads
List \$2515

~~\$666~~ **\$555**



Yamaha Concert Toms Low Range

New! Stock Clearance
CT3456 13", 14", 15", 16"
BLACK Gloss Finish
Single Headed
8 Ply Birch and mahogany shells
Remo Controlled Sound heads
with black dot
Includes double braced WS-860A heavy duty stands
List \$1448

~~\$777~~ **\$666**

*2 Available

Selmer 74 Paris Professional Tenor Sax Reference 54 Series

Demo Model; No Dents! No Scratches! Minor discoloration under lacquer finish. Completely cleaned and adjusted.

Tenor Saxes made in the Spirit of the 1954 Mark VI

Solid centered sound

Vintage matte finish body & keys; gives it an aged 1954 appearance

High F# key

Bell is stamped Selmer Paris Reference 54.

There is no additional engraving.

Includes Selmer C* mouthpiece & deluxe black lightweight case

List \$11,925



10 Payments of
\$500

No Trade Required or
Single Payment of \$5000 NT



Scan with your phone



Taylor Music
www.taylormusic.com
513 S. Main St.
Aberdeen, SD 57401

PRSR1 STD
U.S. POSTAGE
PAID
Madison, SD
Permit #32



taylormusic^{inc.}

Enjoy Your Summer!

May 2015



WWW.TAYLORMUSIC.COM
1.800.872.2263

 Find us on
Facebook
fb.com/TaylorMusicInc

Mov'em Out Sale!

Miraphone S191 Rotary Tuba with MTS Case

New; Full Size Compact Model. German Craftsmanship. Produces a big dark sound. Key of BBb. 4 Rotary valves. Brass finish. Solid nickel silver leadpipe. .835" Bore. 19" Large upright bell with nickel resonance band. Direct valve stroke. Height 36". Weight 22 lbs. Includes Mirafone mouthpiece & Taylor 1200 MTS Tuba Case. List \$14,752

~~Was \$8025~~

**\$7750
no trade**

Miraphone 191-4U Rotary Tuba

Demo Model; NO Dents! Very minor finish scratches on bottom nickel bow guard. Completely cleaned and adjusted. Full Size Compact Model. Professional German Craftsmanship. Produces a big dark sound. Nickel silver slide tubes. Key of BBb. 4 Rotary valves. Brass finish. Solid nickel silver leadpipe. Direct valve stroke linkage. .835" Large bore. 19" Large upright bell with nickel resonance band. Height 36". Weight 22 lbs. Includes Mirafone TU33 mouthpiece. List \$15,194

~~Was \$7750~~

**\$7450
no trade**

Miraphone 289-4U 5/4 Tuba with Case

Used, Excellent Condition! NO Dents! Crease in bell flare removed. Visible crease lines and light scratches from removal process. Completely flushed, cleaned & adjusted. 5/4 Size. Key of BBb. Brass finish with nickel trim. Nickel silver inner slide tubing. Nickel silver leadpipe. 4 Standard Rotary valves (Ergonomic style). 18.5" Upright bell with nickel resonance band. .0803"-.0835" Bore. 1 Standard waterkeys. Extra tuning slide for A. Tunable thumb ring for personal comfort. 38" Total length. Includes optional 2nd tuning slide for A443 tuning. Includes TU33 Miraphone mouthpiece, Jacob Winter case with recessed wheels & padded blue Miraphone gig bag with backpack straps. List \$16,104

~~Was \$7250~~

**\$6250
no trade**

Meinl Weston 25 Rotary Tuba

Reconditioned! All dents & scratches removed. Instrument is stripped, buffed, polished & completely relacquered. Completely cleaned & adjusted. Professional German Full Size Model. Key of BBb. Brass finish with nickel trim. Nickel silver leadpipe. 4 Rotary valves. 17.75" Upright bell. .748" Bore. 41.7" Total height. Includes Miraphone TU29 mouthpiece. List \$14,057

~~Was \$6250~~

**\$5750
no trade**

Jupiter 590L Quad Sousa with Case

Used, good condition! Nice bright brass appearance. Minor dents. Visible finish scratches. Completely cleaned and adjusted. University Quad Sousa. Lacquered Brass finish. 4 Valve. .736" Concert bore. 26" Bell. Removable front action valve and slide section. Weighs 31 lbs. Includes mouthpiece & hard shell case with wheels. List \$8175

~~Was \$4222~~

**\$3950
no trade**

Yamaha 6200 Series Timpani Intermediate Copper Model

New! Freely suspended polished copper bowls. Recessed ears in rims. Steel rim suspension ring. Teflon tape on bearing edge. Thick tuning rods protected in struts. Spider mechanism protected under base. Smooth, balanced spring mechanism. Cable-linked tuning gauge w/accidental indicators. 4" Heavy duty locking casters. Black hardware. Pedal adjustment clutch. Custom clear Remo Renaissance head w/aluminum insert ring. Includes Fiber head cover, long drop covers & timpani key. List \$10,608

TP6229ACL Copper Single 29"

~~Was \$1866~~

**\$1650
no trade**

TP6202ACL Copper Set of 2: 26" & 29"

~~Was \$4444~~

**\$4150
no trade**

Bach 180S43 Strad Trumpet

Demo Model; used for a weekend performance. NO Dents! NO finish scratches! Completely cleaned and polished. Professional Stradivarius Model. Bright silver finish. Standard weight body & 43 bell. Standard construction #25 mouthpiece. Monel pistons. .459" Medium large bore. One piece Stradivarius style brass valve casing. Brass in tone tuning slide. Nickel silver tuning slide receiver. Brass mouthpiece receiver. 1st Valve slide thumb hook. 3rd Valve slide fixed finger ring with adjustable stop mechanism. Includes Bach 7C mouthpiece and deluxe wood shell case. List \$3948

~~Was \$2629~~

**\$2150
no trade**

Yamaha YV2700GC Vibe

New! Intermediate Studio Model. Quiet motor; 3 Octaves. Graduated; Glossy Gold bars & resonators. Height adjustable Durable frame has upper & lower crossbar supports and horizontal leg supports. Includes Cover. Range: F-F3. Bar Sizes: Graduating from 1.5" - 2.25" x .5" Dimensions: 56.25" x 32.25" Height Adjustable: 31 7/8" to 35" Gold finish resonators. YVM200 Motor w/silent pause control; 25-150 rpm. Swivel; oversized pedal. Weight: 125.5 lbs. Oversized 4" casters (two locking). Pitch: A=442Hz. List \$9418

~~Was \$4888~~

**\$4550
no trade**

Talis TEU170S Euphonium

New! Talis by B&S Intermediate Model. Bright silver finish. Key of Bb. 11.75" Upright bell. .610" Bore. 3 Upright valves. Stainless steel valves. Standard waterkeys. Bass shank mouthpiece receiver. Length: 26". Includes B&S 6 1/2AL mouthpiece and lightweight blue softshell case with backpack straps. List \$3295

~~Was \$950~~

**\$850
no trade**

Talis by B&S TTB355**Tenor Trombone**

New! Intermediate Model. Clear lacquer finish with nickel trim. Key of Bb. 8" Bell; .500" Bore. Nickel silver outer slide tubes. Includes B&S 6 1/2AL mouthpiece and lightweight blue softshell case with backpack strap. List \$1925

~~Was \$450~~**\$350
no trade****Armstrong 703 Alto Flute**

Demo Model; minor finish scratch. Good pads. Completely cleaned and adjusted. Armstrong Heritage Series. Straight and curved headjoints. Silver plated head, body and foot. Pointed cup arms with 5 Pearl contact pads. Range to low C. Includes French style case and cover. List \$2654

~~Was \$1495~~**\$1250
no trade****Pearl Maesta Silver Flute Model 9800RBCDH/F97RGH**

Maesta Silver Series; Professional Handmade Japan Flutes. Pearl Custom features: C# Trill Key, D# Roller, Plated Rose Gold Lip plate. Forte Heavy Wall (.45mm) Headjoint with plated rose gold lip plate. .970 Pristine silver (.45mm). Designed for larger orchestras and concert halls. Very responsive. Produces a dark centered tone. A wide dynamic range is ensured throughout the entire registers. Plated rose gold lip plate gives warmer sound. 9800 Series Features: Solid Sterling Silver .925 tube. Heavy wall (.45mm) tube. .925 Solid sterling silver keys. Open hole. Drawn tone holes with pointed key arms. White gold springs. Pearl's pinless construction & one piece core bar. Range to low B. Inline G. Includes French style wood case & padded case cover, cleaning rod and polishing cloth. List \$7970

~~Was \$3950~~**\$2950
no trade****Selmer 53 Paris Soprano Sax**

New! Professional Series III Paris Model. Clear lacquer body & keys. Straight brass body with clear lacquer finish. Hand engraved body. Two necks (one straight & one curved). High F# & high G keys. Tilting Bb spatula. Adjusting screws on low B-C#, low B-Bb, A, G and low B. Kid pads. Metal resonators. Includes deluxe lightweight softshell case & Selmer Paris C* mouthpiece. List \$7800

~~Was \$4750~~**\$4450
no trade****Selmer 84F (Reference 36) Paris Tenor Sax**

Demo! Display Model; NO Dents! Minor discoloration specks under lacquer. Professional Paris Reference 36 Model made in the Spirit of the 1936 Balanced Action. Broad-flexible sound. Vintage lacquered finish body & keys give it an aged appearance. Vintage Matte finish; no engraving. High F# key. Includes Selmer C* mouthpiece and deluxe black lightweight case. List \$11,925

~~Was \$6450~~**\$5750
no trade****Bach TB301 Tenor Trombone**

Beginner Return! Student USA Model. Minor finish scratches. Completely cleaned & adjusted. Student Model. .500" bore. 8" bell, Includes mouthpiece and case. List \$1301

~~Was \$500~~**\$450
no trade****Avanti 2000BIF Flute**

New! Discontinued Model previously distributed by Conn-Selmer. Professional USA Model. Handcut .925" sterling silver Avanti-Brannen headjoint. French Style (open hole). .925" Sterling silver body and foot. Silver plated keys. Range low B. Inline G/A. C# trill key. 10K White gold springs. Includes French style case with cover. List \$3350

~~Was \$2699~~**\$1350
no trade****King 625SB Silver Baritone**

Demo Model; small blemish on outside of bell. Completely cleaned & adjusted. Diplomat Student Model. Satin Silver finish with Bright Silver plated trim. 3 Front action valves. 11" Bell front bell. Pull rings on 1st & 2nd slides. .562" Bore. Includes hard shell case and mouthpiece. List \$3352

~~Was \$1450~~**\$1150
no trade****Selmer 1944 Balance Action Paris Alto Saxophone**

Used, good condition. NO major dents. Visible finish scratches and wear on the back side and bottom bow. New pads. Completely cleaned and adjusted. The alto sax appears to have been relacquered. Last owner purchased this over 60 years ago and the refinish work appears to have been done before his time. We believe it was a factory refinish job but can't confirm this. 1944 Vintage Professional Paris Model. Dark gold lacquer finish on body and keys. Range to high F (No high F#). Engraved bell and bottom bow. Includes new Selmer Vanguard Case and Selmer C* mouthpiece with cap & ligature. List \$NA

~~Was \$3950~~**\$3650
no trade****Selmer VI 1968-69 Paris Tenor Saxophone**

Reconditioned! Our Best Overhaul! New lacquer brass finish on body and keys. Lightly buffed. New pads. Completely cleaned and adjusted. Professional Paris Mark VI 1968-69 Vintage Model. Range to high F. Sharp crisp engraving on bell. Includes Selmer Paris C* mouthpiece and near new deluxe Selmer wood shell case. List \$NA

~~Was \$4200~~**\$3750
no trade****Megavox MEGA8000U1 Pro Basic PA Sound System**

Demo; used less than 30 days! MegaVox Pro Basic Package Includes: MEGA8000U1 Unit w/ Bluetooth & 1 Wireless Receiver. SS550 Heavy Duty Speaker Stand. WB8000 Body Pack Transmitter. HBM-TA4F Headset Mic. List \$1556

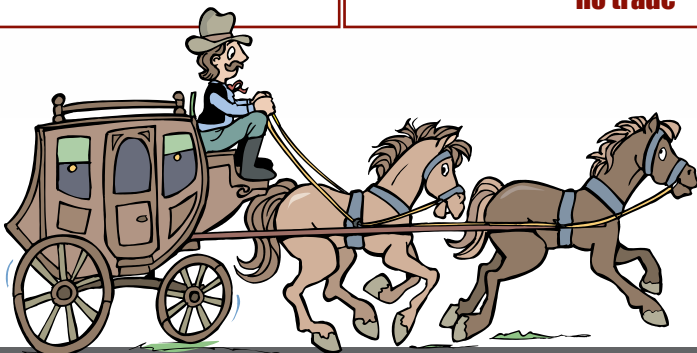
~~Was \$1264~~**\$1050
no trade**



REFINISHED FLUTES

REFINISH JOB INCLUDES:

1. Instrument is disassembled & completely cleaned
2. Minor plating wear on body and keys; good lip plating
3. Buffed and polished
4. All new pads
5. Complete adjustment and testing
6. Good Used case

List \$899



**Our Selection
Major Brands**
 Armstrong
 Artley
 Blessing
 Buescher
 Emerson
 Gemeinhart
 Selmer

\$250
 No Trade



REFINISHED Bb CLARINETS

Major Brands
 Plastic Body
 Nickel Plated Keys
 List \$935



REFINISH JOB INCLUDES:

1. Instrument is disassembled & completely cleaned
2. Necessary corks, felts & springs replaced
3. All new pads
4. Minor plating wear on keys
5. Complete adjustment and testing
6. Good mouthpiece, cap & ligature
7. Good Used case

**Our Selection
Major Brands**
 Bundy
 Buescher
 Normandy
 Vito



\$250
 No Trade



REFINISHED Eb ALTO CLARINETS

Plastic Body
 With Nickel Keys
 List \$2400



**Our Selection
Major Brands**
 Buescher
 Bundy
 Normandy
 Vito

\$350
 No Trade





Stand not included

REFINISHED ALTO SAXOPHONES

Student Model
Major Brands
Brass Finish on Body
Nickel or Brass Keys
List \$1845

\$600
No Trade



Our Selection
Major Brands
Buescher
Bundy
Cleveland
Conn
Jupiter
Martin
Vito



Stand not included

REFINISHED TENOR SAXOPHONES

Student Model
Major Brands
Brass Finish on Body
Nickel or Brass Keys
List \$2180

\$700
No Trade



Our Selection
Major Brands
Buescher
Bundy
Cleveland
Conn
Jupiter
Martin
Vito

REFINISH JOB INCLUDES:

1. Large dents and scratches removed
2. Body is lightly buffed, polished & relacquered
3. Minor plating wear on nickel keys
4. New pads, corks & felts
5. Entire instrument is disassembled and completely cleaned
6. Complete adjustment and testing
7. Good mouthpiece, cap and ligature
8. Good Used case



REFINISHED CORNETS

List \$1080



\$300
No Trade



Our Selection Major Brands
Blessing - Bundy - Cleveland - Conn - King - Olds



REFINISHED TRUMPETS

List \$1080



\$350
No Trade



Our Selection Major Brands
Blessing - Bundy - Cleveland
Conn - Holton - Jupiter
King - Olds - Reynolds



REFINISHED TROMBONES

List \$1035



\$350
No Trade



Our Selection Major Brands
Blessing - Cleveland
Conn - Holton - Olds



REFINISH JOB INCLUDES:

1. Large dents and scratches removed
2. Instrument is stripped, lightly buffed, polished and relacquered
3. New corks, felts and springs
4. Completely flushed and ultrasonically cleaned
5. Proper adjustment of valves/slide
6. Silver plated mouthpiece
7. Good Used case





REFINISHED 'Bb' SINGLE FRENCH HORNS

KEY OF Bb

REFINISH JOB INCLUDES:

1. Large dents and scratches removed
 2. Entire instrument is lightly buffed & polished
 3. New lacquer finish
 4. Completely flushed and ultrasonically cleaned
 5. Proper alignment of rotors
 6. Silver plated mouthpiece
 7. Good used case
- List \$2395

\$400
No Trade



Our Selection Major Brands
Conn - Cleveland - Getzen - King - Olds - Reynolds



REFINISHED F SINGLE FRENCH HORNS

KEY OF F

REFINISH JOB INCLUDES:

1. Large dents and scratches removed
 2. Entire instrument is lightly buffed & polished
 3. New lacquer finish
 4. Completely flushed and ultrasonically cleaned
 5. Proper alignment of rotors
 6. Silver plated mouthpiece
 7. Good used case
- List \$2455

\$500
No Trade



Our Selection Major Brands
Conn - Cleveland - Getzen - King - Olds - Reynolds

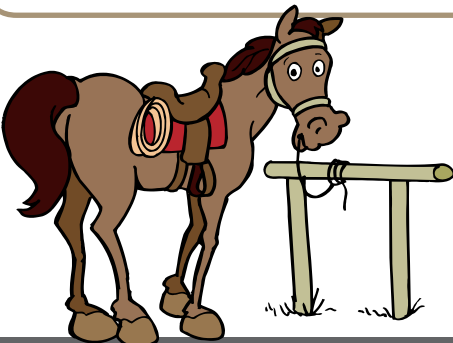

REFINISHED BARITONES

Bell Front Models

REFINISH JOB INCLUDES:

1. Large dents and scratches removed
 2. Entire instrument is lightly buffed & polished
 3. New lacquer finish
 4. Completely flushed and ultrasonically cleaned
 5. Proper alignment of valves
 6. Silver plated mouthpiece
 7. Good used case
- List \$2520

**Our Selection
Major Brands**
Besson
Cleveland
Conn
Holton
King
Olds



\$700
No Trade



Stock Closeout Sale!

BRITTON 305 SOPRANO SAX

New! Import Student Model
Straight body with detachable straight neck
Solid construction with ribbed posts
Dark gold lacquer finish on body and keys
High F# key
Beautifully engraved with flower design
Includes lightweight case & student mouthpiece
Includes **FREE Bonus E. Rousseau Classic 4R Rubber Mouthpiece**

\$400 no trade
10 Payments of \$40 nt



BRITTON 310 TRUMPET

New! Import Student Model
Key of Bb
Beautiful metal combinations; brass, red brass & nickel
Clear lacquer finish
4 7/8" Red brass bell
Red brass leadpipe
.459" medium large bore
1st slide thumb hook
Fixed 3rd slide ring with stop rod
2 Standard waterkeys
Includes 7C mouthpiece & lightweight plastic case

\$200 no trade
10 Payments of \$20 nt



BRITTON 309 FLUGELHORN

New! Import Advanced Series Model
6" Red brass bell
Red brass 1st branch
Brass valve section with nickel trim
Monel valves
.427" bore
3 Standard water keys
3rd Slide trigger
Adjustable leadpipe
Includes lightweight case & silver plated mouthpiece

\$450 no trade
10 Payments of \$45 nt



BRITTON 313F JUNIOR SINGLE FRENCH HORN

New! Import Student Junior Model
Small wrap and bell throat is great for
younger players through junior high
Key of F
11" Bell with small throat
Brass finish with nickel trim
Mechanical linkage
.460" Bore
Adjustable thumb hook
Includes mouthpiece and lightweight
softshell case with detachable straps

\$450 no trade
10 Payments of \$45 nt



0%
INTEREST

10
Payments

FREE SHIPPING
U.S. Contiguous



ADAMS MT1 MARCHING TRUMPET

Key of Bb
.460" Bore
5" Bell diameter
Stainless steel valves
2.2 lbs
Includes stackable ABS case and mouthpiece

Brass Finish List \$2400
Silver Finish List \$2500

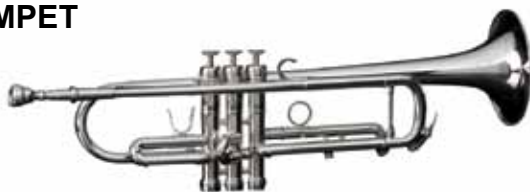

MT1 Brass Finish \$1100 no trade

MT1S Silver Finish \$1150 no trade

ADAMS MM1 MARCHING MELLOPHONE

Key of F
.468" Bore
10" Bell diameter
Stainless steel valves
3.3 lbs
Includes stackable ABS case and mouthpiece

Brass Finish List \$3100
Silver Finish List \$3395



MM1 Brass Finish \$1425 no trade

MM1S Silver Finish \$1550 no trade

ADAMS MF1 MARCHING FRENCH HORN

Key of Bb
.470" Bore
11" Bell diameter
Stainless steel valves
3.9 lbs
Includes stackable ABS case and mouthpiece

Brass Finish List \$3795
Silver Finish List \$4095



MF1 Brass Finish \$1750 no trade

MF1S Silver Finish \$1900 no trade

New Kid in town!
Try a FREE test drive on
Adams
Marching Brass



ADAMS MB1 MARCHING BARITONE

Key of Bb
.571" Bore
10" Bell diameter
Stainless steel valves
5.6 lbs
Includes stackable ABS case and mouthpiece

Brass Finish List \$4250
Silver Finish List \$4500



MB1 Brass Finish \$1950 no trade
MB1S Silver Finish \$2050 no trade



ADAMS MM1 MARCHING EUPHONIUM

Key of Bb
.571" Bore
11" Bell diameter
Stainless steel valves
6.8 lbs
Includes stackable ABS case and mouthpiece

Brass Finish List \$5150
Silver Finish List \$5500



ME1 Brass Finish \$2350 no trade
ME1S Silver Finish \$2500 no trade



ADAMS MTB1 MARCHING TUBA

Key of Bb
.689" Bore
19" Bell diameter
Stainless steel valves
21 lbs
Includes stackable ABS case and mouthpiece

Brass Finish List \$12,950
Silver Finish List \$13,500



MTB1 Brass Finish \$5950 no trade
MTB1S Silver Finish \$6150 no trade



Call 1-800-872-2263
to arrange.
(MTB1 Tuba excluded)



Blessing BM100 Marching Mellophone

New!
Key of F
.468" Bore
10.5" Bell
Monel pistons
Standard waterkeys
French Horn mouthpiece adapter
Includes #5 mellophone mouthpiece
and wood shell case
List \$2395



Blessing BM301 Marching Baritone

New!
Key of Bb
.560" bore
10" bell
Includes 6 1/2AL mouthpiece
& wood shell case
List \$2395



Blessing BM401 Marching 'Bb' French Horn

New!
Key of Bb
11" Bell
.460" Bore
Includes case and mouthpiece
List \$2395



YOUR FINISH CHOICE

\$1050

**BRASS FINISH
NO TRADE**



\$1200

**SILVER FINISH
NO TRADE**

Jupiter US Army All American Band Specials

These were new instruments used by some of America's finest
for a one week clinic and performance.

Very minor dents and scratches. Completely cleaned and adjusted.

Jupiter 5000L Marching Trumpet

Demo!
Ergonomic tuning trigger placement & durable construction
Clear Lacquer finish
Key of Bb
.460" Bore
5" Bell
Stainless steel pistons
Weighs 2.6 lbs
Includes wood frame case and mouthpiece
List \$1560



\$750 no trade

Jupiter 5050L Marching Mellophone

Demo!
Ergonomic tuning trigger placement & durable construction
Clear Lacquer finish
Key of F
.460" Bore
10.7" Bell
Stainless steel pistons
Weighs 2.6 lbs
Includes wood frame case and mouthpiece
List \$1940



\$1000 no trade

Jupiter 590L Sousaphone

Demo!
University Quad Sousaphones
Lacquered Brass finish
4 Valve
.736" Concert bore
26" Bell
Sousas have removable front action valve and slide section
Weighs 31 lbs
Includes mouthpiece & hard shell case w/wheels
List \$8175



\$4650 no trade

JUPITER[®]

Econo

FREE SHIPPING

U.S. Contiguous



Conn 14K, King 2350

Sousaphones

ECONO OVERHAUL

The Economy Overhaul Job saves hundreds of dollars from traditional reconditioning jobs yet the remaining dents & scratches are not noticeable from a short distance.

List \$8522

JOB INCLUDES:

1. Removal of all major dents and scratches
2. Entire instrument is stripped, buffed, polished & relacquered
3. New corks & felts
4. Completely flushed and ultrasonically cleaned
5. Nickel plated, hand lapped valves
6. New mouthpiece, neck & bits

King 2350 Shown



\$3250 no trade

Add \$1000 for Bright Silver or Satin Silver



Vinyl Sousa Case with Recessed Wheels

ADD \$325

Metal Sousa

Trade Allowances:

\$400 Each for Buescher, Cleveland, Holton, Olds, Pan American, Reynolds

\$500 Each for SILVER Conn 14K or King 2350

\$750 Each for BRASS Conn 14K or King 2350

\$1000 Each for SILVER Conn 20K

\$1250 Each for BRASS Conn 20K

FREE!
Sousa Pads
Neck Pouch &
Bach Mouthpiece

Total list \$253



Size Choice:
18
22
24AW

Econo

FREE SHIPPING

U.S. Contiguous

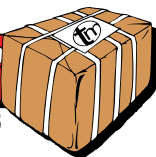

Conn 20K Sousaphones

ECONO OVERHAUL SHORT ACTION VALVES

The Economy Overhaul Job saves hundreds of dollars from traditional reconditioning jobs yet the remaining dents & scratches are not noticeable from a short distance.

List \$9631

BODY --Metal
KEY --Bb
BELL --26"
BORE --.734"



JOB INCLUDES:

1. Removal of all major dents and scratches
2. Entire instrument is stripped, buffed, polished & relacquered
3. New corks & felts
4. Completely flushed and ultrasonically cleaned
5. Nickel plated, hand lapped valves
6. New mouthpiece, neck & bits



\$4150

no trade

Add \$1000 for Bright Silver or Satin Silver



Vinyl Sousa Case with Recessed Wheels

ADD
\$325

FREE!
**Sousa Pads
Neck Pouch &
Bach Mouthpiece**

Total list
\$253



Size
Choice:
18
22
24AW

Fiberglass Sousa Trade Allowances:

\$250 Each for

Bundy, Jupiter, Olds, Reynolds, Signet

\$400 Each for

Conn 22K, Conn 36K, King 2370, Yamaha

Marching Mellophones



**Bach 887 Mercedes
Marching Mellophone**

Status: Econo
Finish: Brass
Key: F
Bell: 10.5" Bell
Bore: .468"
Case: Included
New List \$2395

No Trade \$875

*2 Available



**Dynasty 440
Marching Mellophone**

Status: Econo Overhaul
Finish: Brass
Key: F
Bell: 10.5" Bell
Bore: .460"
Case: Included
New List \$NA

No Trade \$775



**Kanstul 281
Marching Mellophone**

w/1st slide spring loaded,
adjustable ring
Status: Econo Overhaul
Finish: Brass
Key: F
Bell: 10.5" Bell
Bore: .460"
Case: Included
New List \$1950

No Trade \$875



**Bach 887S Mercedes
Marching Mellophone**

Status: Econo
Finish: Bright Silver
Key: F
Bell: 10.5" Bell
Bore: .468"
Case: Included
New List \$2595

No Trade \$975

*3 Available



**Dynasty 441
Marching Mellophone**

Status: Econo Overhaul
Finish: Brass
Key: F
Bell: 10.5" Bell
Bore: .468"
Case: Included
New List \$NA

No Trade \$875



**Kanstul KMM281S
Marching Mellophone**

Status: Used, good
Finish: Bright Silver
Key: F
Bell: 10.5" Bell
Bore: .460"
Case: Included
New List \$2188

No Trade \$775



**Bach B1105THS
Marching Mellophone
(Identical to King 1120)**

Status: Demo
Finish: Bright Silver
Key: F
Bell: 10.5" Bell
Bore: .468"
Case: Included
New List \$2544

No Trade \$1195



**Dynasty M541
Marching Mellophone**

Status: Econo Overhaul
Finish: Brass
Key: F
Bell: 9.75" Bell
Bore: .468"
Case: Included
New List \$NA

No Trade \$875



**Olds A42
Marching Mellophone**

Status: Econo Overhaul
Finish: Brass
Key: F
Bell: 10" Bell
Bore: .468"
Case: Included
New List \$2395

No Trade \$775

*2 Available

Marching Mellophones



**King 1120
Marching Mellophone**

Status: Econo
Finish: Brass
Key: F
Bell: 10" Bell
Bore: .468"
Case: Included
New List \$NA

No Trade \$875

*9 Available



**King 1121 Ultimate
Marching Mellophone**

w/1st slide saddle with
spring loaded return
Status: Demo
Finish: Brass
Key: F
Bell: 10.5" Bell
Bore: .468"
Case: Included
New List \$2301

No Trade \$1195

*9 Available



**Yamaha YMP202
Marching Mellophone**

Status: Econo
Finish: Brass
Key: F
Bell: 10" Bell
Bore: .463"
Case: Included
New List \$2338

No Trade \$875



**King 1120SP
Marching Mellophone**

Status: Econo
Finish: Bright Silver
Key: F
Bell: 10" Bell
Bore: .468"
Case: Included
New List \$2596

No Trade \$995

*5 Available



**King 1121SP Ultimate
Marching Mellophone**

w/1st slide saddle with
spring loaded return
Status: Demo
Finish: Bright Silver
Key: F
Bell: 10.5" Bell
Bore: .468"
Case: Included
New List \$2596

No Trade \$1395

Marching Trumpet



**King SB12SP System Blue
Marching Trumpet**

Status: Demo; NO Dents!
Finish: Bright Silver
Key: Bb
Bell: 5"
Bore: .464"
Case: Included

No Trade \$995



Marching French Horns (Key of Bb)



Kanstul 285 Bb
Marching French Horn
Finish: Brass
Key: Bb
Bell: 10"
Bore: .470"
Case: Includes Used Case
 New List \$2460

Status: Used, Good. Major dents removed. Some small dents remain; visible finish wear.

No Trade \$555

*12 Available

Status: Refinished. Large dents and scratches removed. New clear lacquer finish.

No Trade \$775

Status: Econo Overhaul. All major dents and scratches removed. New clear lacquer finish.

No Trade \$875

King 1122 (Bb)
Marching French Horn
Key: Bb
Bell: 10"
Bore: .468"
Case: Included
 New List \$2863

Status: Used, Good. Major dents removed. Some small dents remain; visible finish wear.

Finish: Brass

No Trade \$595

*11 Available

Status: Econo Overhaul. All major dents and scratches removed. New clear lacquer finish.

Finish: Brass

No Trade \$875

*2 Available

Status: Used, Good. Major dents removed. Some small dents remain; visible finish wear.

Finish: Bright Silver

No Trade \$875

Yamaha YHR302MS (Bb)
Marching French Horn
Finish: Silver
Key: Bb
Bell: 10"
Bore: .472"
Case: Included
 New List \$3192

Status: Used, Good. Noticeable small dings and minor finish scratches

No Trade \$875

*2 Available

Status: Used, Excellent. Minor dings & finish scratches

No Trade \$995

*6 Available

Marching French Horns (Key of F)



Accord (F) Marching French Horn
(Identical to Blessing M400)
Status: Econo Overhaul
Finish: Brass
Key: F
Bell: 11"
Bore: .460"
Case: Included
 New List \$2395

No Trade \$775

*5 Available

Marching Trombones



Blessing M200
Marching Trombone
Status: Econo Overhaul
Finish: Brass
Key: Bb
Bell: 8.5"
Bore: .500"
Case: Included
New List \$NA

No Trade \$875

*2 Available



King 1130 Flugabone
Marching Trombone
Status: Econo Overhaul
Finish: Brass
Key: Bb
Bell: 8.5"
Bore: .500"
Case: Included
New List \$NA

No Trade \$995

*2 Available



Deg Compact
Marching Trombone
Status: Used, Fair condition.
Visible dents and finish
scratches, Slight plating wear
Finish: Bright Silver
Key: Bb
Bell: 7.25"
Bore: .515"
Case: Included
Length: 15"
New List \$NA

No Trade \$595

*2 Available



Bach 888 Mercedes
Marching Trombone
Status: Econo Overhaul
Finish: Brass
Key: Bb
Bell: 8.5"
Bore: .515"
Case: Included
New List \$NA

No Trade \$995

Marching Baritones



Bach 1106
Marching Baritone
 Identical to Yamaha YBH301M
Status: Econo Overhaul
Finish: Brass
Key: Bb
Bell: 10"
Bore: .571"
Case: Included
 New List \$3288

No Trade \$1095



Blessing M300
Marching Baritone
Status: Econo Overhaul
Finish: Brass
Key: Bb
Bell: 10"
Bore: .560"
Case: Included
 New List \$2395

No Trade \$875



Dynasty 571
Marching Baritone
Status: Econo Overhaul
Finish: Brass
Key: Bb
Bell: 10"
Bore: .560"
Case: Included
 New List \$NA

No Trade \$995



Bach 888
Marching Baritone
Status: Econo Overhaul
Finish: Brass
Key: Bb
Bell: 10"
Bore: .560"
Case: Included
 New List \$NA

No Trade \$995

***2 Available**



Conn 136E
Marching Baritone
(Identical to King 1124)
Status: Econo Overhaul
Finish: Brass
Key: Bb
Bell: 10"
Bore: .500"
Case: Included
 New List \$3089

No Trade \$995



Yamaha YBH301M
Marching Baritone
Finish: Brass
Key: Bb
Bell: 10"
Bore: .571"
Case: Included
 New List \$3288

Status: Econo Overhaul

No Trade \$1095

Status: Demo; NO Dents!
 8 small scratches on bottom of bell bow.

No Trade \$1595



Bach 888S
Marching Baritone
Status: Econo Overhaul
Finish: Bright Silver
Key: Bb
Bell: 10"
Bore: .560"
Case: Included
 New List \$NA

No Trade \$1195

***2 Available**



Dynasty 570
Marching Baritone
Status: Econo Overhaul
Finish: Brass
Key: Bb
Bell: 10"
Bore: .560"
Case: Included
 New List \$NA

No Trade \$875

***6 Available**



Marching Baritones, Euphoniums, Tubas



King 1124
Marching Baritone
Finish: Brass
Key: Bb
Bell: 10"
Bore: .500"
Case: Included
 New List \$3089

Status: Econo Overhaul

No Trade \$995

*7 Available

Status: Demo; NO Dents!
 Minor finish scratches.

No Trade \$1595

*4 Available

Jupiter 5070S
Marching Euphonium
Status: Used, good. Minor dents; visible finish scratches on back side of bell bow
Finish: Bright Silver
Key: Bb
Bell: 11"
Bore: .592"
Weight: 7.6 lbs
Case: Includes Original case
 New List \$3780

No Trade \$1195

Yamaha YEP202M
Marching Euphonium
Status: Used, good. Minor dents and finish scratches
Finish: Brass
Key: Bb
Bell: 11"
Bore: .571"
Weight: 7.6 lbs
Case: Good used case
 New List \$4046

No Trade \$1195

*7 Available



King 1124SP
Marching Baritone
Finish: Bright Silver
Key: Bb
Bell: 10"
Bore: .560"
Case: Included
 New List \$3384

Status: Econo Overhaul
 New Silver plated finish

No Trade \$1195

Status: Demo; NO Dents!
 Minor finish scratches.

No Trade \$1795

Kanstul 200 5/4 Size
Marching Tuba w/Case
 (Exclusive for marching over the left shoulder)

Status: Econo Overhaul
Finish: Brass
Key: Bb
Valves: 3 Upright
Bell: 21" Detachable
Bore: .689"
Case: Includes good used 2 Pc case
 New List \$7850

No Trade \$2995

*6 Available

Eb Tubas



Blessing ATU-EB Accord Concert Eb Tuba

Status: Demo; minor dents and finish scratches

Finish: Brass w/nickel trim

Size: 3/4

Key: Eb

Bell: 14 3/8" Upright

Valves: 3 Upright action

Bore: .660"

Case: INCLUDED

List \$NA

no trade \$700

*11 Available



Blessing ATU-EBGB Accord Concert Eb Tuba

Status: Used, Excellent!

Visible small dents and finish scratches

Finish: Glass beaded body w/lacquer finish

Size: 3/4

Key: Eb

Bell: 14 3/8" Upright

Valves: 3 Upright action

Bore: .660"

Case: INCLUDED

List \$NA

no trade \$400

*4 Available



York 377 3/4 Eb Tuba

Status: Demo; minor dents and finish scratches

Finish: Brass w/nickel trim

Size: 3/4

Key: Eb

Bell: 16" Upright

Valves: 3 Upright action

Bore: .662"

Case: Includes Softshell with backpack straps

List \$NA

no trade \$750

*7 Available



Blessing ATU-EBGB Accord Concert Eb Tuba

Status: Demo; minor dents and finish scratches

Finish: Glass beaded body w/lacquer finish

Size: 3/4

Key: Eb

Bell: 14 3/8" Upright

Valves: 3 Upright action

Bore: .660"

Case: INCLUDED

List \$NA

no trade \$600

*4 Available



Conn 14J Eb Tuba

Status: Econo Overhaul

Finish: Brass

Size: 3/4

Key: Eb

Bell: 16" Upright

Valves: 3 Upright action

Bore: .625"

Case: Add \$275

List \$NA

no trade \$700



3/4 Tubas



Besson 682 Tuba
Status: Econo Overhaul
Finish: Brass
Size: 3/4
Key: Bb
Bell: 13" Upright
Valves: 3 Upright action
Bore: .689"
Case: Add \$225 (#225)
List \$NA

no trade \$1750

*2 Available



Holton BB450 Collegiate Tuba
Status: Demo! NO Dents!
Minor finish scratches.
Finish: Brass
Size: 3/4
Key: Bb
Bell: 14.5" Upright
Valves: 3 Upright action
Bore: .669"
Case: INCLUDED
List \$4753

no trade \$2150



King 1135W Tuba
Status: Demo! Minor dents
and finish scratches.
Finish: Brass
Size: 3/4
Key: Bb
Bell: 14 7/8" Upright
Valves: 3 Front action
Bore: .660"
Case: INCLUDED
List \$6714

no trade \$2950

*10 Available



Yamaha YBB103 Tuba
Status: Econo Overhaul
Finish: Brass
Size: 3/4
Key: Bb
Bell: 14 3/8" Upright
Valves: 3 Front action
Bore: .610"
Case: Add \$245 (#1205)
List \$NA

no trade \$1750

*4 Available



York 387L Tuba
Status: Demo; minor dents
and finish scratches
Finish: Brass w/nickel trim
Size: 3/4
Key: Bb
Bell: 16" Upright
Valves: 3 Upright action
Bore: .662"
Case: Includes Softshell
with backpack straps
List \$NA

no trade \$1750



York 387S Tuba
Status: Demo; minor dents
and finish scratches
Finish: Bright Silver
Size: 3/4
Key: Bb
Bell: 16" Upright
Valves: 3 Upright action
Bore: .662"
Case: Includes Softshell
with backpack straps
List \$NA

no trade \$1750

*8 Available



FULL Size Tuba



Conn 5JW Tuba
Status: Demo! NO Dents!
 Minor finish scratches; small
 flux leak on brace.
Finish: Brass
Size: Full
Key: Bb
Bell: 18" Upright
Valves: 4 Front action
Bore: .658"
Case: INCLUDED
 List \$9695

no trade \$4450

Musica Austrian 3 Valve Tuba
Status: Refinished! Large
 dents and scratches removed.
 New clear lacquer finish.
Finish: Brass
Size: Full
Key: Bb
Bell: 15.75" Upright
Valves: 3 Upright
Bore: .640"
Case: Add \$295
 List \$NA

no trade \$1450

Olds O99 Tuba
Status: Econo Overhaul
Finish: Brass
Size: Full
Key: Bb
Bell: 16" Upright
Valves: 3 Front action
Bore: .656"
Case: Add \$295
 List \$NA

no trade \$1750



King 1140 Tuba
Status: Econo Overhaul
Finish: Brass
Size: Full
Key: Bb
Bell: 15" Upright
Valves: 3 Upright
Bore: .640"
Case: Add \$295
 List \$6079

no trade \$1850

*3 Available

King 1140W Tuba
Status: Demo! Minor dent and
 finish scratches.
Finish: Brass
Size: Full
Key: Bb
Bell: 15" Upright
Valves: 3 Upright
Bore: .640"
Case: INCLUDED
 List \$6854

no trade \$3150

*3 Available



Deg Schafer 851 Tuba
Status: Econo Overhaul
Finish: Brass
Size: Full
Key: Bb
Bell: 15" Upright
Valves: 3 Upright
Bore: .670"
Case: Add \$325
 List \$4550

no trade \$1650

*3 Available

Musica Austrian 4 Valve Tuba
Status: Refinished! Large
 dents and scratches removed.
 New clear lacquer finish.
Finish: Brass
Size: Full
Key: Bb
Bell: 15.75" Upright
Valves: 4 Upright
Bore: .640"
Case: Add \$295
 List \$NA

no trade \$1750



Reynolds Contempora Tuba
Status: Econo Overhaul
Finish: Brass
Size: Full
Key: Bb
Bell: 16" Upright
Valves: 4 Front action
Bore: .656"
Case: Add \$295
 List \$NA

no trade \$2150

*3 Available

Rotary Valve Tubas

Meinl Weston 25 Rotary Tuba

Status: Reconditioned! Our Best!
Size: Full
Finish: Brass w/nickel trim
Key: Bb
Valves: 4 Rotary
Bell: 17.75" Upright
Bore: .748"
Height: 41.7"
Case: Add \$495 for Case
New List \$14,057

no trade **\$5750**
was ~~\$6250-nt~~

Miraphone 191-4U

Compact Rotary Tuba
Status: Demo! NO Dents! Very minor finish scratches on bottom nickel bow guard.
Size: Full
Finish: Brass
Key: Bb
Valves: 4 Rotary
Bell: 19" Upright with Nickel resonance band
Bore: .835"
Height: 36"
Case: Add \$475
New List \$15,194

no trade **\$7450**
was ~~\$7750-nt~~

Miraphone 289-4U 5/4 Rotary Tuba

Status: Used, Excellent! NO Dents! Bell flare was creased at one time. Crease removed. Crease line & light scratches are visible.
Size: 5/4
Finish: Brass w/nickel trim
Key: Bb
Valves: 4 Rotary (Ergonomic)
Bell: 18.5" Upright with Nickel resonance band
Bore: .0803"-.0835"
Height: 38"
Case: INCLUDED
New List \$16,104

no trade **\$6250**
was ~~\$7250-nt~~

Recording Tubas (Bell Front)

Conn 24J Tuba

Status: Econo Overhaul
Size: Recording
Finish: Brass
Key: Bb
Valves: 4 Upright - Short Action
Bell: 24" Front detachable
Bore: .775"
Case: Add \$495 for Case
New List \$NA

no trade **\$2750**

King 2340 Tuba (22" BF)

Status: Econo Overhaul
Size: Recording
Finish: Brass
Key: Bb
Valves: 3 Front Action
Bell: 22" Front detachable
Bore: .678"
Case: Add \$495 for Case
New List \$7350

no trade **\$1850**

*2 Available

Reynolds Recording Tuba

Status: Econo Overhaul
Size: Recording
Finish: Brass
Key: Bb
Valves: 3 Front Action
Bell: 22.5" Front detachable
Bore: .686"
Case: Add \$495 for Case
New List \$NA

no trade **\$1650**

*2 Available

Recording Tubas (Upright)

Holton BB460R Tuba

similar to Yamaha YBB321
Status: Econo Overhaul
Size: Recording
Finish: Brass
Key: Bb
Valves: 4 Upright Action
Bell: 17.5" Upright
Bore: .728"
Case: Add \$475 for Case
New List \$NA

no trade **\$2750**

King 2340 Tuba (19" BU)

Status: Econo Overhaul
Size: Recording
Finish: Brass
Key: Bb
Valves: 3 Front Action
Bell: 19" Upright detachable
Bore: .678"
Case: Add \$495 for Case
New List \$7350

no trade **\$2150**

Reynolds Recording Tuba

Status: Econo Overhaul
Size: Recording
Finish: Brass
Key: Bb
Valves: 3 Front Action
Bell: 20" Upright
Bore: .686"
Case: Add \$495 for Case
New List \$NA

no trade **\$1950**





MIRAPHONE 186-4U ROTARY TUBA

Miraphone's #1 Selling Model

New!

Professional German Quality

Key of Bb

4 rotary valves

Brass finish with nickel trim

Nickel silver leadpipe

.772" bore

17 3/4" upright bell with

nickel resonance band

Direct Valve Stroke linkage

Includes Miraphone mouthpiece

39" Tall, 22 Lbs

List \$13,984

~~\$7550 nt~~

Hot Summer Deal! Ends Aug 31st

\$7250 no trade



MIRAPHONE 187-4U ROTARY TUBA

New! Full Size Tubas

German Craftsmanship

Key of BBb

4 Rotary valves

Nickel resonance band on bell

Brass finish with nickel trim

Solid nickel silver leadpipe

Direct valve stroke linkage

17.75" Upright bell

.772" Bore

Taper on conical rotor section goes faster

than traditional 186 model (give tuba a

bigger, fuller and darker sound)

Height 39"

Weight 21 lbs

Includes Miraphone mouthpiece

List \$14,978

\$7950 no trade



**New Vinyl Case with
Recessed Wheels
Add \$475**





MIRAPHONE 1291-4U TUBA

BIG BORE WITH COMPACT DESIGN!

New!
Full Size
German Craftsmanship
Key of BBb
4 front action piston valves
Nickel silver leadpipe
18.5" upright bell
.835" bore
Brass construction with nickel trim
35.5" tall, 22 lbs
Includes Miraphone TU33 mouthpiece
List \$17,154

\$9150 no trade



MIRAPHONE 191-4U TUBA

BIG BORE WITH COMPACT DESIGN!

New!
Full Size
German Craftsmanship
Key of BBb
4 rotary valves
Brass finish with nickel trim
Solid nickel silver leadpipe
Direct valve stroke linkage
.840" large bore
19" large upright bell with
nickel resonance band
Miraphone TU33 mouthpiece
36" tall, 22 lbs
List \$15,194

\$8050 no trade



**New Vinyl Case with
Recessed Wheels
Add \$475**

PEARL COMPETITOR SERIES MARCHING SNARES



PEARL COMPETITOR MARCHING SNARE DRUMS

Lightweight for extra comfort
All Mahogany shell
8 Steel lugs

CMS1309/C 9" x 13"

List \$442

\$211

CMS1412/C 12" x 14"

List \$515

\$244



PEARL HI-TENSION FFX COMPETITOR SNARE DRUMS

Hi-tension FFX aluminum alloy edge ring
8 ply 100% mahogany shell
Throw-off mechanism
Lightweight for extra comfort

CMSX1311/C 11" x 13"

Weight 12.9 Lbs

List \$696

\$322

CMSX1412/C 12" x 14"

Weight 13.9 Lbs

List \$764

\$355

Snare Carrier Options

Pearl MXS1



ADD
\$133

TM-HD



ADD
\$99

FREE SHIPPING
U.S. Contiguous



Standard Finishes:
Pure White
Midnight Black

PEARL COMPETITOR SERIES MARCHING BASS & TOMS



PEARL COMPETITOR MARCHING BASS DRUMS

8 ply - 100% mahogany shell
Hi-tension styled lug casings
6 ply all maple hoops
Triple reinforced claws
Excellent projection
Lightweight for player's comfort
List \$577 - \$916

Size	Model	Sale
14 x 14	CMB1414/C	\$266
14 x 16	CMB1614/C	\$277
14 x 18	CMB1814/C	\$311
14 x 20	CMB2014/C	\$333
14 x 22	CMB2214/C	\$366
14 x 24	CMB2414/C	\$377
14 x 26	CMB2614/C	\$399
14 x 28	CMB2814/C	\$444

Standard Finishes:
Pure White
Midnight Black

Bass Carrier:

MXB1



**ADD
\$111**

PEARL COMPETITOR MARCHING TOMS w/Carrier

Lightweight Competitor Series. Power cut drums with protective vinyl trim.
Provides excellent projection. Lightweight for player's comfort. 8 ply 100% mahogany shell.



PEARL COMPETITOR QUAD CMT8023/CXN (w/Carrier)

Sizes: 8", 10", 12", 13"
List \$1221

\$577

Includes
MXT4-1



PEARL CHAMPIONSHIP SERIES SNARE & BASS DRUMS



PEARL FFXM CHAMPIONSHIP MARCHING SNARE DRUMS

New 2015 Model!

2 lb Weight reduction w/One touch strainer

Polished Aluminum Hardware

Totally free floating shell

100% Maple Shell

Aluminum alloy edge ring supports all batter head

tension, allows the shell to resonate freely

Six air vents in the shell for maximum sound projection

Redesigned lightning strainer with quick release

16 individually adjustable synthetic snare strands

Die cast top & bottom hoops

\$444

FFXM1311/A 11" x 13"

10 Hi-Tension Steel Lugs

List \$1008

FFXM1412/A 12" x 14"

12 Hi-Tension Steel Lugs

List \$1147.50

\$488

Snare Carrier

CXS1

ADD \$199



Standard Finishes:

Pure White

Midnight Black

Brushed Silver
Wrapped finish
Discontinued



Bass Carrier

CXB1



ADD \$199



PEARL CHAMPIONSHIP MARCHING BASS DRUMS

New 2015 Model!

Polished Aluminum Hardware

6 ply all maple shell

with angle cut bearing edge

Hi-tension styled lug casings

6 ply all maple hoops

Triple reinforced solid steel bass drum claws

for hi-tension tuning

List \$853 - \$1636

Size	Model	Sale
14 x 14	PBDM1414	\$388
14 x 16	PBDM1614	\$411
14 x 18	PBDM1814	\$455
14 x 20	PBDM2014	\$499
14 x 22	PBDM2214	\$511
14 x 24	PBDM2414	\$533
14 x 26	PBDM2614	\$588
14 x 28	PBDM2814	\$611
16 x 30	PBDM3016	\$699
16 x 32	PBDM3216	\$722



PEARL CHAMPIONSHIP SERIES MARCHING TOMS



PEARL CHAMPIONSHIP MARCHING TOMS w/Carrier

New 2015 Model! Tenors have been upgraded with a new tom spacer.
Allows for tighter configurations and less play between the drums.
Polished Aluminum Hardware.

**CXT1
(included)**



carrier only
\$222

Includes CXT1 CX AirFrame Tom Carrier
Power cut drums with protective vinyl trim
Heavy duty casing, hoops & tension rods
6 ply cross laminated all maple shells

PMTM8023/AXN QUAD (w/Carrier)

Sizes: 8", 10", 12", 13"
List \$2081

\$955

PMTM68023/AXN QUINT (w/Carrier)

Sizes: 6", 8", 10", 12", 13"
List \$2923

\$1111

PMTM668023/AXN SEXTET (w/Carrier)

Sizes: 6", 6", 8", 10", 12", 13"
List \$3412

\$1255

Standard Finishes:
Pure White
Midnight Black

Brushed Silver
Wrapped finish
Discontinued

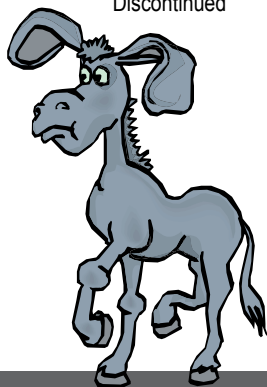

**LUDWIG CHALLENGER
USA FREE FLOATING
SNARE DRUM** **\$555**

LFF024DMS, 12 x 14, Silver Hardware, Totally Free Floating shell. Lightweight, only 15 lbs. 3.5mm, 4 ply cross laminated birch & maple. Integrated Finish add strength to shell and longevity to finish. Magnesium Die-Cast top and bottom hoops. 12 - 6mm USA heat treated steel lugs. Steel swivel nut receivers. P90 Strainer. Individually adjustable synthetic gut snares with snare guards. Hi-torque Ludwig head. Includes 3 Year Manufacturer Warranty. List \$1030



LUDWIG SNARE CARRIERS:

LF5740 Aluminum Omni w/J-Hooks, **Add \$166**

LF6740 Aluminum Vest w/J-Hooks, **Add \$199**

LUDWIG CHALLENGER SERIES BASS DRUMS

5.7mm, 6 ply cross-laminated Birch and integrated finish shells. 9.4mm, 10 ply cross-laminated Birch and integrated finish hoops. Strider heads, 12 Classic lugs. All bass drums include one pair of Ludwig aluminum shaft bass drum mallets. Includes 3 Year Manufacturer Warranty. List \$1005 - \$1535



LUDWIG BASS CARRIERS:

LFS5741 Aluminum Omni **Add \$166**

LFS6741 Aluminum Vest **Add \$222**

Size	Model	Sale
14 x 16	LFC216XL	\$544
14 x 18	LFC218XL	\$555
14 x 20	LFC220XL	\$566
14 x 22	LFC222XL	\$588
14 x 24	LFC224XL	\$611
14 x 26	LFC226XL	\$644
14 x 28	LFC228XL	\$655
16 x 30	LFC230XL	\$777
16 x 32	LFC232XL	\$822

LUDWIG CHALLENGER SERIES MARCHING TOMS

5.7mm, 6 ply cross-laminated Birch and integrated finish shells. Deep angle Power Cut shells. Die Cast zinc lug casings with support plates on inside of shell. Strider heads. 12 Classic lugs. New Lightweight Aluminum alloy rail system. Over 2 lbs lighter, Easy adjustment & set-up. Includes 3 Year Manufacturer Warranty. Includes Omni T-Style Carrier.

LFC483NR QUAD

with Omni T-Style Carrier

Sizes: 8", 10", 12", 13"
List \$1834

Sale \$999



FINISHES AVAILABLE:

White Cortex
Black Cortex
Red Cortex



LFC563NR QUINT

with Omni T-Style Carrier

Sizes: 6", 8", 10", 12", 13"
List \$2154

Sale \$1177



Upgrade To LF6744 Aluminum Vest Carrier **Add \$44**



Dynasty Snare Drums

DFZ14 MARCHING SNARE

12" x 14" hard rock maple 8 ply shell
"Endurite" aluminum die cast hoop
with suspension collar

Silver powder coated hardware
with chrome posts

12 lug tuning with "Endurite" aluminum
bottom lug casings

One touch throw off with horizontal
and vertical adjustments

12 individually tunable synthetic gut snares

2 chrome plated snare guards

J-bar mounting brackets installed

Lightweight – 16.8 lbs

List \$1100

\$466



FREE SHIPPING
U.S. Contiguous



**Free Shipping on
orders of four or more
Dynasty Drums**

Dynasty
USA



Dynasty Bass Drums

8 ply hard rock maple shells
12 ply maple hoops in black, made extra
strong for high torque tuning

Chrome hardware

10 solid wide extra strong claw hooks
for even distribution of tension

Futuristic "Endurite" extruded
aluminum lug casings

List \$780 - \$1500

Size	Model	Sale
14 x 14	MBD14	\$359
14 x 16	MBD16	\$379
14 x 18	MBD18	\$429
14 x 20	MBD20	\$459
14 x 22	MBD22	\$469
14 x 24	MBD24	\$489
14 x 26	MBD26	\$529
14 x 28	MBD28	\$549
16 x 30	MBD30	\$629
16 x 32	MBD32	\$659

Snare Carriers w/Tilters

Aluminum T-Bar	\$149
Aluminum Vest	\$239
Aluminum T-Max	\$199

Bass Carriers

Aluminum T-Bar	\$119
Aluminum Vest	\$219
Aluminum T-Max	\$199

Tom Carriers w/Tilters

Aluminum T-Bar	\$179
Aluminum Vest	\$259
Aluminum T-Max	\$219



Marching shell "rounds" 8 ply
hard rock maple with aluminum
reinforcement. **Chrome hardware.**
Futuristic "Endurite" extruded
aluminum two hole lug casings.
Carrier is Additional

Carrier Options



T-Bar Carrier



Vest Carrier



T-Max Carrier

DYNASTY MARCHING QUAD

Sizes: 8", 10", 12", 13"

Model 8023 no Carrier

List \$1500

\$699

DYNASTY MARCHING QUINT

Sizes: 6", 8", 10", 12", 13"

Model 68023 no Carrier

List \$1860

\$869

DYNASTY MARCHING SIXPACK

Sizes: 6", 6", 8", 10", 12", 13"

Model 668023 no Carrier

List \$2200

\$999

FINISHES AVAILABLE:

Black
Designer White
Lapis Blue
Regimental Red
Hunter Green
Slate Grey

YAMAHA SFZ 9300 SERIES MARCHING SNARE DRUMS

For use with high-tension Kevlar heads. Designed for precise articulation, powerful projection and durable performance. 6 Ply Maple with Air-Seal System. High strength, die cast aluminum rim & suspension ring. Chrome hardware. Snare side aluminum insert ring insures stable tuning platform for Kevlar drum heads. Gravity Guards help maintain tuning settings when set against the bottom rim. 3 Removable Protective feet. Includes Remo Falam II K-Series head and Remo Ambassador snare-side clear head.



Red Forest Stain



Blue Forest Stain



Green Forest Stain



White Wrapped



Silk Silver Wrapped

MS9313 11" x 13"

10 Hi-Tension Lugs
List \$924

Sale \$522

MS9314 12" x 14"

12 Hi-Tension Lugs
List \$988

Sale \$544



RM-TSFZ
Aluminum Tube
\$188



RM-TVHMSA
Monoposto Tube
\$277

Snare Carrier Options:



YAMAHA FIELD CORPS MARCHING TOMS



YAMAHA FIELD CORPS MARCHING BASS DRUMS

8300 Series Field Corps. Features Yamaha's exclusive Air-Seal System shell and hoop construction. 7 Ply Maple shells. 10 Ply Maple hoops. Wide body claw. 5.4mm Tension rods. Remo Smooth White Ambassador bass drum heads. Internally pre-muffled with Yamaha Sound Impact Strips. List \$692-\$1142

Size	Model	Sale
14 x 14	MB8314	\$388
14 x 16	MB8316	\$422
14 x 18	MB8318	\$455
14 x 20	MB8320	\$499
14 x 22	MB8322	\$522
14 x 24	MB8324	\$544
14 x 26	MB8326	\$588
14 x 28	MB8328	\$622
16 x 30	MB8330	\$644
16 x 32	MB8332	\$666

8300 Series Field Corps feature Yamaha's exclusive Air-Seal System shell construction. 6" & 8" Deep cut 7 ply maple shells. 10" & 12" Deep cut 6 ply maple shells. Lightweight aluminum arch shape lug casing. 2.3mm steel DynaHoop. 5.4mm tension rods. Aluminum reinforcement ring. Remo clear pinstripe heads. Includes Aluminum Tube Lift-front Carrier.



MQT-8023F QUAD

with Aluminum Tube Carrier

Sizes: 8", 10", 12", 13"

List \$1904

Sale \$1025



MQT-68023F QUINT

with Aluminum Tube Carrier

Sizes: 6", 8", 10", 12", 13"

List \$2206

Sale \$1255



MQT-668023F SEXTET

with Aluminum Tube Carrier

Sizes: 6", 6", 8", 10", 12", 13"

List \$2508

Sale \$1425

Bass Carrier Options:



RM-TFCB
Aluminum Tube
\$188



RM-TVHMBB
Monoposto Tube
\$277

Included w/Toms:



RM-TFCQS
Aluminum Tube

Tom Carrier Upgrade:



RM-TVHBPTA Biposto
Contour Hinge
Add \$111



YAMAHA

FINISHES AVAILABLE:

Wrapped Finishes:

Silky Silver
White



Stain Finishes:

Black Forest
Blue Forest
Red Forest



FREE SHIPPING
U.S. Contiguous



TAYLOR MUSIC'S TM24/7

MARCHING BASS DRUMS

Stock Closeout Sale



Limited Stock

Sizes Available:
14 x 26
14 x 28

TAYLOR MUSIC TM 24/7 MARCHING BASS DRUMS

Professional Series
 7 Ply Birch Shells
 9mm Birch Hoops with Color Inlay
 Chrome Die Cast long lugs
 Smooth White drum heads
 Carrier Eyelets

Includes Foam Inserts glued on the interior on both playing sides of the shell for muting overtones.

\$129 with NO Carrier

**Your Choice
 White or Black ***



TM24/7 Carrier

add \$88

* The Black Vinyl finish tends to warp when left in the hot sun for a period of time. Standard warranty applies, however, there is no warranty on vinyl wrap.

CLOSEOUT



Taylor T-Style Snare Carrier (with J-Bars)

New! Stock Clearance Sale!!

Lightweight durable aluminum Powder coated; black/gray, swivel brackets allow drum to be tilted back when not in use, height adjustment on belly plate and J-bars, sponge padding on contact points. Easy to attach/un-attach carrier from drum. Includes marching swivel brackets.

Sale \$111

*4 Available



Taylor Aluminum Snare Carrier Item #TM-HD Snare

New! Black powder coat finish. Sponge padding on 1 7/8" wide shoulder bars. 5" Belly plate. Height adjustable for all players.

Snare attachment clips to free floater rods or slides on snare clip. Flip feature allows player to position drum sideways (shifts weight closer to player).

Weights 6 lbs 4 oz.

Fits Models w/Clip Brackets:
Pearl FFX Free Floater
Championship & Competitor
Yamaha SFZ, MTS, Field Corp

Sale \$122

*4 Available



Taylor Aluminum Bass Carrier Item #TM-HD Bass

New! Black powder coat finish. Sponge padding on 1 7/8" wide shoulder bars. 5" Belly plate. Height adjustable for all players. 5" Belly plate. Weighs 7 lbs.

Clips hook to any bass drum with eye bolts. (Eye bolts not included)

Sale \$88

*25 Available



Randall May Tube Snare Carrier Item #U-ALTS

Used, good condition. Minor scuffs and scratches. Aluminum belly plate. Rotating shoulder adjustment. Height adjustable. Includes free floating snare attachment (fits 13" & 14" drums; designed to fit on tube style lugs).

Sale \$111



Pearl Tube Monoposto Snare Carrier Item #U-THMS-BLK

Used, good condition. Minor scuffs and scratches. Tube carrier designed with a hinge in the middle tube section for comfort and body adjustments. Adjustable black belly plate with cushioned back support. Rotating shoulder adjustment. Height adjustable. Includes free floating snare attachment (fits 13" & 14" drums; designed to fit on tube style lugs).

Sale \$166

*6 Available



Musser M8067 Marching Xylophone w/Cart

Used, Good condition! Bars and frame shows minor finish wear. Completely cleaned and adjusted. 2.5 Octave. C5-G7 Range; A440 Tuning. Non-graduated kelson bars; 1.5" wide, 7/8" thick. Silver resonators. Includes New M8005 Keyboard Cart with 5" casters

List \$2610
Sale \$888



Musser M66 Marching Xylophone w/Cart

Used, Good condition! Bars and frame shows minor finish wear. Completely cleaned and adjusted. 2.5 Octave. C5-G7 Range; A440 Tuning. Non-graduated kelson bars; 1.5" wide, 7/8" thick. Silver resonators. Includes New M8005 Keyboard Cart with 5" casters and pair of mallets. List \$2610

Sale \$888

10"x14"

Sale \$122



Ludwig Marching Snare Drum #425-BLG Blue Sparkle Finish with Gold Sparkle middle stripe
Size: 10x14, 8 Center Lugs
Used, good condition. Minor scuffs and scratches. Wood shell, metal hoops. Wire snares with P85 quick throw off. Includes new heads & sticks. List \$NA

*2 Available

10"x14"

Sale \$122



Ludwig Marching Snare Drum #2489-B Black Finish
Size: 10x14, 10 Long Lugs
Used, good condition. Minor scuffs and scratches. Wood shell, metal hoops. Gut snares with classic throw off. Includes new heads & sticks. List \$NA

*2 Available

10"x14"

Sale \$77



Ludwig Marching Snare Drum #2478-GS Faded Gold Sparkle
Size: 10x14, 8 Short Lugs
Used, fair condition. Obvious nicks. Minor scuffs and scratches. Wood shell, metal hoops. Wire snares with P85 quick throw off. Includes new heads & sticks. List \$NA

12"x14"

Sale \$144



Slingerland Marching Snare Drum #2490-C Finish
Size: 12x14, 12 Long Lugs
Used, good condition. Minor scuffs and scratches. Wood shell, metal hoops. Gut snares with quick throw off. Includes new heads & sticks. List \$NA

*2 Available

12"x14"

Sale \$166



Yamaha Marching Snare Drum #2498-B Black Finish
Field Corp Series
Size: 12x14, 12 Long Lugs
Used, good condition. Minor scuffs and scratches. Wood shell, die cast top and bottom hoops. Gut snares with quick throw off. Includes new heads & sticks. List \$NA

12"x14"

Sale \$133



Slingerland Marching Snare Drum #2480-W White Finish
Size: 12x14, 10 Long Lugs
Used, good condition. Minor scuffs and scratches. Wood shell, metal hoops. Wire snares with P85 quick throw off. Includes new heads & sticks. List \$NA

12"x14"

Sale \$166



Ludwig Marching Snare Drum #2485-W White Finish
Size: 12x14, 12 Long Lugs
Used, good condition. Minor scuffs and scratches. Wood shell, metal hoops. Synthetic gut snares with classic throw off. Includes new heads & sticks. List \$1020

*2 Available

12"x14"

Sale \$166



Yamaha Marching Snare Drum #2482-B Black Finish
MS8014 Field Corp Series
Size: 12x14, 12 Long Lugs
Used, good condition. Minor scuffs and scratches. Wood shell, die cast top & bottom hoops. Gut snares with quick throw off. Includes new heads & sticks. List \$NA

12"x14"

Sale \$144



Slingerland Marching Snare Drum #2484-W White Finish
Size: 12x14, 12 Long Lugs
Used, good condition. Minor scuffs and scratches. Wood shell, metal hoops. Wire snares with P85 quick throw off. Includes new heads & sticks. List \$NA

12"x15"

Sale \$155



Slingerland Marching Snare Drum #2491-B Recovered Black Finish
Size: 12x15, 10 Long Lugs
Used, good condition. Minor scuffs and scratches. Wood shell, metal hoops. Gut snares with quick throw off. Includes new heads & sticks. List \$NA

12"x15"

Sale \$133



Slingerland Marching Snare Drum #2481-W White Finish
Size: 12x15, 12 Long Lugs
Used, good condition. Minor scuffs and scratches. Wood shell, metal hoops. Gut snares with quick throw off. Includes new heads & sticks. List \$NA



18" or 22"

Limited Stock **White or Black**
\$149



**Taylor TM24/7
Marching Bass**

**Sizes: 14 x 18 or 14 x 22
New! Stock Closeouts.**

Professional Series. 7 Ply Birch Shells. 9mm Birch Hoops with Color Inlay. Chrome Die Cast long lugs. Smooth White drum heads. Carrier Eyelets. Includes Foam Inserts glued on the interior on both playing sides of the shell for muting overtones.

18"

**Sale
\$144**



**Slingerland
Marching Bass**

Item #1566-B Black Finish
Size: 12 x 18, 8 Long Lugs
Used, Good condition. Minor scuffs and scratches. Wood shell, wood hoops. Includes new heads and pair of mallets. List \$NA

20"

**Sale
\$122**



**Slingerland
Marching Bass**

Item #1568-B Black Finish
Size: 12 x 20, 8 Long Lugs
Used, Good condition. Minor scuffs and scratches. Wood shell, wood hoops. Missing badge. Recovered shell. Includes new heads and pair of mallets. List \$NA

20"

**Sale
\$277**



**Mapex
Marching Bass**

**QCB2014 Quantum Series
Item #661-BL Blue Finish**

Size: 14 x 20, 10 Tube Lugs
Demo Model. Minor nicks, scratches & scuffs, wood shell, wood hoops, includes heads & mallets. List \$1020

20"

**Sale
\$155**



**Ludwig
Marching Bass**

**Strider Series
Item #1569-W White Finish**
Size: 14 x 20, 8 Short Lugs
Used, Good condition. Minor scuffs and scratches. Wood shell, wood hoops. Missing badge. Includes new heads and pair of mallets. List \$NA

20"

**Sale
\$122**



**Slingerland
Marching Bass**

Item #1568-B Black Finish
Size: 12 x 22, 8 Long Lugs
Used, Good condition. Minor scuffs and scratches. Wood shell, wood hoops. Missing badge. Recovered shell. Includes new heads and pair of mallets. List \$NA

22"

**Sale
\$177**



**Yamaha
Marching Bass**

Item #1567-B Black Finish

Powerlite Series
Size: 12 x 24, 8 Short Lugs
Used, Good condition. Minor scuffs and scratches. Wood shell, wood hoops. Includes new heads and pair of mallets. List \$664

22"

**Sale
\$177**



**CB700
Marching Bass**

Item #1563-W White Finish
Size: 14 x 22, 10 Long Lugs
Used, good condition. Minor nicks, scuffs and scratches. Wood shell, metal hoops. Includes new heads and pair of mallets. List \$NA

22"

**Sale
\$177**



**Ludwig
Marching Bass**

**Challenger Series
Item #1564-B Black Finish**
Size: 14 x 22, 12 Long Lugs
Used, Good condition. Minor scuffs and scratches. Wood shell, metal hoops. Missing badge. Recovered drum. Includes new heads and pair of mallets. List \$1075

22"

**Sale
\$188**



**Pearl
Marching Bass**

**Championship Series
Item #1545-B Black Finish**

Size: 14 x 22, 12 Long Lugs
Used, Good condition. Minor scuffs and scratches. Wood shell, wood hoops. Includes new heads and pair of mallets. List \$1064

22"

**Sale
\$166**



**Pearl
Marching Bass**

**Competitor Series
Item #1565-B Black Finish**

Size: 14 x 22, 10 Long Lugs
Used, Good condition. Minor scuffs and scratches. Wood shell, wood hoops. Includes new heads and pair of mallets. List \$764

22"

**Sale
\$155**



**Slingerland
Marching Bass**

Item #990-C Chrome Finish
Size: 14 x 22, 10 Long Lugs
Used, fair condition. Obvious scuffs and scratches. Wood shell, wood hoops. Includes new heads and pair of mallets. List \$NA

24"

**Sale
\$177**



**Ludwig
Marching Bass
Challenger Series
Item #1556-B Black Finish**
Size: 14 x 24, 10 Short Lugs
Used, Good condition. Minor scuffs
and scratches. Wood shell, wood
hoops. Includes new heads and
pair of mallets. List \$1135

24"

**Sale
\$177**



**Ludwig
Marching Bass
Item #1560-B Black Finish**
Size: 14 x 24, 12 Long Lugs
Used, Good condition. Minor scuffs
and scratches. Wood shell, metal
hoops. Includes new heads and
pair of mallets. List \$1135

24"

**Sale
\$177**



**Ludwig
Marching Bass
Challenger Series
Item #632-B Black Finish**
Size: 14 x 24, 12 Long Lugs
Used, Good condition. Minor scuffs
and scratches. Wood shell, metal
hoops. Includes new heads and
pair of mallets. List \$1135

24"

**Sale
\$177**



**Slingerland
Marching Bass
Item #1557-B Black Finish**
Size: 14 x 24, 10 Long Lugs
Used, Good condition. Minor scuffs
and scratches. Wood shell, wood
hoops. Includes new heads and
pair of mallets. List \$NA

24"

**Sale
\$177**



**Yamaha
Marching Bass
Field Corp Series
Item #1548-B Black Finish**
Size: 14 x 24, 12 Long Lugs
Used, Good condition. Minor scuffs
and scratches. Wood shell, wood
hoops. Includes new heads and
pair of mallets. List \$942

24"

**Sale
\$177**



**Yamaha
Marching Bass
Field Corp Series
Item #977-W White Finish**
Size: 14 x 24, 12 Long Lugs
Used, Good condition. Minor scuffs
and scratches. Wood shell, metal
hoops. Includes new heads and
pair of mallets. List \$942

26"

**Sale
\$188**



**Ludwig
Marching Bass
Challenger Series
Item #1538-B Black Finish**
Size: 14 x 26, 12 Long Lugs
Used, Good condition. Minor scuffs
and scratches. Wood shell, metal
hoops. Includes new heads and
pair of mallets. List \$1185

26"

**Sale
\$188**



**Ludwig
Marching Bass
Item #1559-B Black Finish**
Size: 14 x 26, 12 Long Lugs
Used, Good condition. Minor scuffs
and scratches. Wood shell, wood
hoops. Includes new heads and
pair of mallets. List \$1185

26"

**Sale
\$188**



**Slingerland
Marching Bass
Item #1561-BD
Black Diamond Pearl Finish**
Size: 14 x 26, 10 Short Lugs
Used, Good condition. Minor scuffs
and scratches. Carrier bracket
holes plugged with epoxy. Missing
badge. Wood shell, wood hoops.
Includes new heads and pair of
mallets. List \$NA

26"

**Sale
\$188**



**Yamaha
Marching Bass
Powerlite MB6126U Series
Item #1554-B Black Finish**
Size: 14 x 26, 12 Long Lugs
Used, Good condition. Minor scuffs
and scratches. Wood shell, metal
hoops. Includes new heads and
pair of mallets. List \$700

26"

**Sale
\$188**



**Yamaha
Marching Bass
Field Corp Series
Item #793-W White Finish**
Size: 14 x 26, 12 Long Lugs
Used, Good condition. Minor scuffs
and scratches. Wood shell, metal
hoops. Includes new heads and
pair of mallets. List \$992

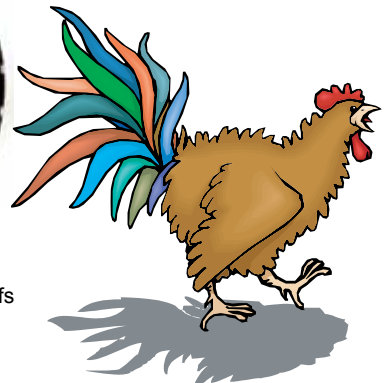

Sale
\$333



**Ludwig Marching Trio w/Carrier
Item #4-R Red Cortex**

Sizes: 10/12/13

with T-Style Carrier (Flip-up)

Used, good condition. Minor nicks and scuffs. Wood shell, cutaway style, metal rims. New heads and pair of mallets. List \$1521

Sale
\$333



**Pearl Marching Trio w/Carrier
Item #4011-B Black
Championship Series**

Sizes: 10/12/14

with XL Carrier (Flip-up Brackets)

Used, good condition. Minor nicks and scuffs. Wood shell, cutaway style, metal rims. New heads and pair of mallets. List \$NA

Sale
\$355



**Ludwig Marching Trio w/Carrier
Item #5-R Red Cortex**

Sizes: 10/12/13

with Vest Carrier (J-Bar Flip-up)

Used, good condition. Minor nicks and scuffs. Wood shell, cutaway style, metal rims. New heads and pair of mallets. List \$1521

Sale
\$411



**Pearl Marching Quad w/Carrier
Item #9004-B Black
Championship Series**

Sizes: 10/12/13/14

with T-Style Carrier

Used, good condition. Minor nicks and scuffs. Wood shell, cutaway style, metal rims. New heads and pair of mallets. List \$2005

Sale
\$399



**Slingerland Marching
Quad w/Carrier
Item #9002-B Black**

Sizes: 8/10/12/13

with T-Style Carrier

Used, good condition. Minor nicks and scuffs. Wood shell, cutaway style, metal rims. New heads and pair of mallets. List \$NA

Sale
\$399



**Yamaha Marching
Quad w/Carrier
Item #9003-B Black**

Sizes: 8/10/12/13

with T-Style Rail Carrier

Used, good condition. Minor nicks and scuffs. Wood shell, cutaway style, metal rims. New heads and pair of mallets. List \$1904

Dynasty Marching Drum Line Slate Grey Finish

Used, good condition. Visible minor nicks and scuffs. All drums have a wood shell, quints cutaway style with metal rims, bass drums have wood rims and diecast rims top & bottom on snares. Each drum includes new

TM T-Style Lightweight carrier. Height adjustable carrier has padded shoulder supports and contact points. Also Includes new heads, sticks and mallets. New List \$18,470

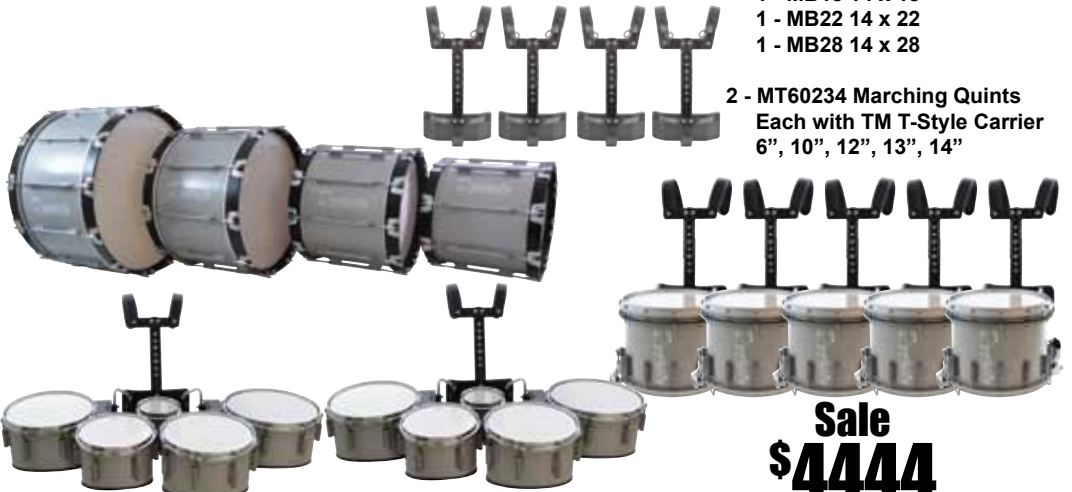

Drum Line Includes:

5 - DFX 12 x 14

Marching Snare Drums

Each with TM T-Style Carrier

4 - Marching Bass Drums

Each with TM T-Style Carrier

1 - MB16 14 x 16

1 - MB18 14 x 18

1 - MB22 14 x 22

1 - MB28 14 x 28

2 - MT60234 Marching Quints

Each with TM T-Style Carrier

6", 10", 12", 13", 14"

Sale
\$4444

ADAMS XSKF35 XYLOPHONE



Field Frame



New! Soloist Series with Endurance Field Frame with extra large wheels.
3.5 Octave, Synthetic bars
Range: F4-C8
Pitch: A442
Bars: 1 1/2" wide
Length: 56"
Width: 33" low end, 23" high end
Height Adjustment: 31.5" to 39.3"
Weight: 88 lbs
Complete with mallets & dust cover.
List \$4272

Sale \$2288

ADAMS MCKF43 MARIMBA



Field Frame



New! 4.3 Octave Concert Series with Endurance Field Frame.
Zelon Synthetic bars. Resonators welded for strength. Heavy duty frame with extra large wheels and accessory rails for add on percussion.
Range: A2-C7
Pitch: A-442
Bars: Graduated
Length: 81.5"
Height Adjustment: 34.5" to 42.3"
Weight: 246 lbs
Complete with mallets and dust cover.
List \$7560

Sale \$3988

ADAMS BK3003CF CHIMES



New! 1 1/2 Octave Symphonic Series with Endurance Field Frame.
1 1/2" Chrome plated tubes
Damper system ensures direct damping of both fundamental and upper registers.
Height adjustable, heavy duty field frame.
Large wheels with brakes.
Complete with full length cover & mallet
List \$8186

Sale \$4288



ADAMS GAF33 BELLS

New! 3.3 Octave Glock Artist Model
with Endurance Field Frame
1.25" Round Top Parsifal Steel Bars
C5 - E8 Range
A-442 Hz Tuning
Height Adjustable Field Frame
Natural Wood Oak Rails & End Pieces
Reversible Damper System
Nickel Plated Steel Resonators
Tuning A=442 Hz
Cover and Mallets Included
List \$7430



Field Frame

Sale \$4388



ADAMS VCSF30M VIBRAPHONE

New! 3 Octave Concert Series with
Field frame with motor. Frame allows
easy adjustment for a wide range of
playing heights. Black rails and end
pieces.

Range: F3-F6
Pitch: A-442
Motor: 40-140 RPM
Bars: Wide graduated aluminum
alloy, nickel anodized
Length: 60"
Width: 35.6" low end, 22" high end
Height Adjustment: 35.2" to 41.6"
Weight: 132 lbs
Complete with mallets and dust cover.
New List \$7524



Field Frame

Sale \$3988

Model VCSF30 (No Motor) \$3588



ADAMS MAKF46 MARIMBA

New! 4.6 Octave Artist Series with
Endurance Field Frame. Zelon
Synthetic bars, Black leather rails and
end pieces. Resonators welded for
strength. Heavy duty frame with extra
large wheels and accessory rails for
add-on percussion.

Range: E2-C7
Pitch: A-442
Bars: Graduated
Length: 93.7"
Height Adjustment: 34.7" to 42.5"
Weight: 176 lbs
Complete with mallets and dust cover.
List \$17,322



Field Frame

Sale \$9988



JARVIS

Jarvis Drum Major Podiums

Constructed of lightweight aluminum for easy transport, setup & take down. Made from 5 custom aluminum extrusions these podiums provide maximum quality and durability. Steps & platform have raised ribs & are lined with non-skid tape to prevent slipping.

Model	Height	Platform Size	Sale
1095-2 (9)	24"	24" x 24" (railing additional)	\$395
1093-2 (7)	42"	28" x 28" (railing additional)	\$695
1094-2 (8)	52"	28" x 28" (railing additional)	\$725
1096-2 (10)	52"	36" x 32" (railing additional)	\$875
1200-2 (12)	62"	36" x 32" (railing additional)	\$950
1400-2 (14)	72"	36" x 32" Inc. Railing	\$1150
1500-2 (15)	6'	44" x 72" Scissor Lift w/Railing	\$2995
1173	---	Podium Railing (Specify Model)	\$195

Allow 2-4 Weeks for Factory Delivery.



**Podiums
Excluded from
FREE Shipping Offer**

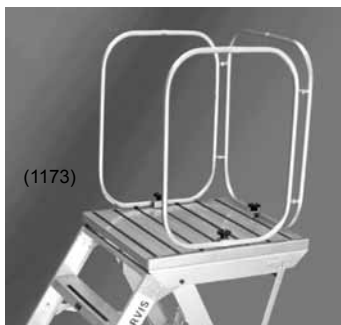

COMMAND CENTER

EQUIPMENT

Space Saver Ladder Podiums

Space saver podiums conserve valuable space in your band room and added relief for your school budgets.

Features Include:

Platform Size: 24" x 27"
Wide, anti-slip steps
Roomy platform size
Simple & easy set up & tear down
Boundary rail
(2) 7" heavy duty transport wheels
Constructed of 6063-T6 aluminum
Finish: Silver or Black

Model	Description	Price
PD48L	4' Silver	\$646
PD48LB	4' Black	\$725
PD60L	5' Silver	\$685
PD60LB	5' Black	\$772
PD72L	6' Silver	\$731
PD72LB	6' Black	\$822



Director's Showcase Podiums



42" & 52" Command Center Podiums

Newly designed making it a snap to get on & off the field in record time!

Features Include:

- Platform Size: 38" x 36"
- Less weight
- New all-weather traction platform
- Easy-on & off boundary rails
- Wider steps
- Removable hand & back boundary rails
- Maneuvers easy on field
- Finish: Silver or Black

Model	Description	Price
PD42	42" Silver	\$710
PD42B	42" Black	\$850
PD52	52" Silver	\$819
PD52B	52" Black	\$950

Podiums Excluded from FREE Shipping Offer Allow 2-4 Weeks for Factory Delivery



PD70

6' Command Center Podium

100% weather proof and can be left out on the marching field all season with confidence.

Features Include:

- Large Platform Size: 4' x 6'
- Nonskid, Heavy duty, lightweight aluminum top
- Ladders on 2 sides for easy access
- Removable front & back boundary rails
- Maneuvers on field in "up" position by pulling only
- Includes (2) 8" pneumatic tires
- Collapsible for easy transport & storage
- Finish: Silver or Black

Model	Description	Price
PD70	Silver	\$1763
PD70B	Black	\$1993
Options:		
PDACCTPS Collapsible Towing Package; Silver		\$198
PDACPDWS Transport Package Silver w/4 heavy duty 10" pneumatic tires (2 swivel, 2 stationary)		\$496



Shown with PDACPDWS Transport Package



Shown with PDACCTPS Towing Package

Evans System Blue Tenor Heads

Item	Size	List	Sale
TT06SB1	6"	\$27.75	\$14
TT08SB1	8"	\$28.75	\$14
TT10SB1	10"	\$29.75	\$15
TT12SB1	12"	\$32.25	\$16
TT13SB1	13"	\$34.25	\$17
TT14SB1	14"	\$36.25	\$18



Evans Corps Clear Tenor Heads

Item	Size	List	Sale
TT06CC	6"	\$25.75	\$13
TT08CC	8"	\$26.75	\$13
TT10CC	10"	\$27.75	\$14
TT12CC	12"	\$29.75	\$15
TT13CC	13"	\$32.25	\$16
TT14CC	14"	\$34.25	\$17

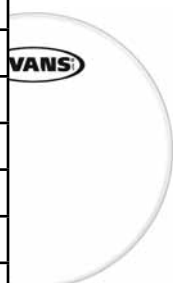

Evans MX White Marching Tenor Heads

Item	Size	List	Sale
TT06MXW	6"	\$29.00	\$14
TT08MXW	8"	\$30.50	\$15
TT10MXW	10"	\$31.50	\$16
TT12MXW	12"	\$33.50	\$17
TT13MXW	13"	\$35.50	\$18
TT14MXW	14"	\$37.75	\$19



Evans Hybrid Snare/Batter Marching Heads

Item	Size	List	Sale
SB13MHG Grey	13"	\$107.00	\$53
SB13MHSB Black	13"	\$96.25	\$48
SB13MHW White	13"	\$107.00	\$53
SB14MHG Grey	14"	\$115.50	\$58
SB14MHSB Black	14"	\$101.75	\$51
SB14MHW White	14"	\$115.50	\$58



Evans MX1 1 Ply Marching Bass Heads Smooth White

Item	Size	List	Sale
BD16MX1W	16"	\$85.75	\$43
BD18MX1W	18"	\$92.25	\$46
BD20MX1W	20"	\$98.50	\$49
BD22MX1W	22"	\$107.00	\$53
BD24MX1W	24"	\$115.50	\$58
BD26MX1W	26"	\$124.25	\$62
BD28MX1W	28"	\$137.00	\$68
BD30MX1W	30"	\$152.25	\$76



Evans MX2 Marching Bass Heads Smooth White

Item	Size	List	Sale
BD16MX2W	16"	\$85.75	\$43
BD18MX2W	18"	\$92.25	\$46
BD20MX2W	20"	\$98.50	\$49
BD22MX2W	22"	\$107.00	\$53
BD24MX2W	24"	\$115.50	\$58
BD26MX2W	26"	\$124.25	\$62
BD28MX2W	28"	\$137.00	\$68
BD30MX2W	30"	\$152.25	\$76



Black

Item	Size	List	Sale
BD16MX1B	16"	\$96.25	\$48
BD18MX1B	18"	\$102.75	\$51
BD20MX1B	20"	\$109.25	\$55
BD22MX1B	22"	\$118.00	\$59
BD24MX1B	24"	\$126.50	\$63
BD26MX1B	26"	\$135.00	\$67
BD28MX1B	28"	\$147.75	\$74
BD30MX1B	30"	\$162.75	\$81



Black

Item	Size	List	Sale
BD16MX2B	16"	\$96.25	\$48
BD18MX2B	18"	\$102.75	\$51
BD20MX2B	20"	\$109.25	\$55
BD22MX2B	22"	\$118.00	\$59
BD24MX2B	24"	\$126.50	\$63
BD26MX2B	26"	\$135.00	\$67
BD28MX2B	28"	\$147.75	\$74
BD30MX2B	30"	\$162.75	\$81



Remo Falam's K Series Marching Heads

Item	Size	Description	List	Sale
KL-0213-SA	13"	Snare Side Bottom	\$75.60	\$37
KS-0213-00	13"	Smooth White	\$77.50	\$38
KS-0213-C2	13"	Smooth White w/Dot	\$82.00	\$41
KS-0214-00	14"	Smooth White	\$80.40	\$40
KS-0214-C2	14"	Smooth White w/Dot	\$83.70	\$42
KL-0214-SA	14"	Snare Side Bottom	\$77.50	\$38

Remo Marching Series Heads

Item	Size	Description	List	Sale
KS-2613-00	13"	White Max	\$99.00	\$49
KS-0613-00	13"	Black Max	\$99.00	\$49
KS-2614-00	14"	White Max	\$101.40	\$51
KS-0614-00	14"	Black Max	\$101.40	\$51

Remo Marching Heads w/Crimplock Clear Pinstripe

Item	Size	List	Sale
PS-0306-MP	6"	\$30.20	\$15
PS-0308-MP	8"	\$33.10	\$16
PS-0310-MP	10"	\$34.40	\$17
PS-0312-MP	12"	\$36.50	\$18
PS-0313-MP	13"	\$38.40	\$19
PS-0314-MP	14"	\$40.00	\$20
PS-0315-MP	15"	\$42.50	\$21

Black Pinstripe

Item	Size	List	Sale
PS-0406-MP	6"	\$30.20	\$15
PS-0408-MP	8"	\$33.10	\$16
PS-0410-MP	10"	\$34.40	\$17
PS-0412-MP	12"	\$36.50	\$18
PS-0413-MP	13"	\$38.40	\$19
PS-0414-MP	14"	\$40.00	\$20

Remo O's Sound Dampening Rings

RO-0014 14" 1 - 1" Wide; 1 - 1.5" Wide **\$8**

RO-0236 Set of 4: 10", 12", 13", 16" **\$12**

Remo Muffl Strips

MF9000 2 - 9' lengths of dense strips 1 1/4" x 7/8". Self-adhesive, pre-notched foam strips for ease of bending.

\$29

Remo Clear Pinstripe 2 Ply Heads

Item	Size	List	Sale
PS-0306-00	6"	\$26.80	\$13
PS-0308-00	8"	\$27.40	\$14
PS-0310-00	10"	\$28.60	\$14
PS-0312-00	12"	\$32.30	\$16
PS-0313-00	13"	\$33.10	\$17
PS-0314-00	14"	\$34.60	\$17
PS-0315-00	15"	\$36.30	\$18
PS-0316-00	16"	\$38.30	\$19
PS-1316-00	16"	\$70.80	\$35
PS-1318-00	18"	\$73.60	\$37
PS-1320-00	20"	\$74.80	\$37
PS-1322-00	22"	\$79.00	\$39
PS-1324-00	24"	\$83.70	\$42
PS-1326-00	26"	\$93.30	\$47
PS-1328-00	28"	\$100.80	\$50
PS-1330-00 *	30"	\$108.40	\$66

*Order & Ship Direct from Factory

Remo Black Pinstripe 2 Ply Heads

Item	Size	List	Sale
ES-0606-PS	6"	\$36.90	\$18
ES-0608-PS	8"	\$38.30	\$19
ES-0610-PS	10"	\$39.70	\$20
ES-0612-PS	12"	\$41.70	\$20
ES-0613-PS	13"	\$42.80	\$21
ES-0614-PS	14"	\$45.20	\$23
ES-0615-PS	15"	\$46.50	\$23
ES-0616-PS	16"	\$49.90	\$25
ES-1616-PS	16"	\$85.30	\$43
ES-1618-PS	18"	\$90.20	\$45
ES-1620-PS	20"	\$94.80	\$47
ES-1622-PS	22"	\$99.00	\$49
ES-1624-PS	24"	\$104.20	\$52
ES-1626-PS	26"	\$110.80	\$55
ES-1628-PS	28"	\$115.80	\$58
ES-1630-PS *	30"	\$126.90	\$76

*Order & Ship Direct from Factory

Taylor Marching Bass & Tom Mallets

Item	Description (Pair)	List	Sale
TM/MT1	Multi-Tenor, Hard Felt Head Gold finished aluminum shaft with black rubber hand grips.	\$38	\$18
TM/JB1	Bass, Small Hard Felt Head Finished hickory wood shafts with rounded hard felt heads. Recommended Use: 16"-20"	\$43	\$22
TM/JB2	Bass, Medium Hard Felt Head Finished hickory wood shafts with rounded hard felt heads. Recommended Use: 22"-24"	\$47	\$23
TM/JB3	Bass, Large Hard Felt Head Finished hickory wood shafts with rounded hard felt heads. Recommended Use: 26"-28"	\$58	\$28
TM/JB4	Bass, X-Large Hard Felt Head Finished hickory wood shafts with rounded hard felt heads. Recommended Use: 28" & up	\$63	\$30
TM/BB	Brass Bell Mallets Small 5/8" round brass head with black finished wood handles. 14.5" Overall length	\$21	\$12

Vic Firth Corpmaster Marching Mallets

Item	Description (Pair)	List	Sale
MT1A	Multi-Tom Nylon head w/aluminum shaft	\$46.75	\$24
MT1AS	Multi-Tom Nylon head w/extra heavy duty aluminum shaft	\$50.15	\$25
MB0H	Bass Drums: 16", 18" X-Small felt head w/wood shaft	\$53.62	\$25
MB1H	Bass Drums: 18", 20", 22" Small felt head w/wood shaft	\$55.00	\$26
MB2H	Bass Drums: 22", 24", 26" Medium felt head w/wood shaft	\$59.40	\$27
MB3H	Bass Drums: 26", 28", 30" Large felt ball w/wood shaft	\$70.15	\$36
MB4H	Bass Drums: 30", 32", 34" Extra large ball w/wood shaft	\$78.10	\$38

Innovative Percussion Marching Sticks & Mallets

Item	Description (Pair)	Sale
IP-FS2	Field Series Drumsticks Reverse tear drop head, short taper, natural finish	\$10
IP-FT1	Field Series Multi-Tom Synthetic head, hickory shaft	\$23
IP-AT2M	Arena Series Multi-Sticks Felt ball end & synthetic small disc end, hickory shaft	\$25
IP-FS250	Marimba Mallets Hard Yarn w/birch handles	\$28
IP-RFS420	Vibraphone Mallets Hard Cord w/birch handles	\$34
IP-FS650	Bells Mallets Hard Plastic w/birch handles	\$24

Taylor Marching Drumsticks

Model	Description (Pair)
TM/MS1	Oval tip, shorter taper; natural finish
TM/SRH	Barrel style tip, slightly longer taper; white finish

\$7 Pair

\$33 Set of 6 pair

\$55 Dozen

Vic Firth Corpmaster Tenor Sticks

Model	Description (Pair)
VFMTS1	Tenor Series Unique nylon tip pulls more sound from drum & articulation with defined high timbre.

\$12 Pair

\$66 Set of 6 pair

\$111 Dozen

Vic Firth Corpmasters Marching Drumsticks

Model	Description (Pair)
SCM	Colin McNutt Oval tip, medium taper, natural finish
VFSRHJR	Ralphie Jr. Scaled down version, white finish
VFSRH	Ralph Hardimon Unique barrel tip, long taper, white finish
VFSLB	Lee Beddis Medium tear drop tip, short taper, natural finish

\$10 Pair

\$55 Set of 6 pair

\$99 Dozen

MegaVox Pro PA Sound System

Great for School Bands, Drum Corps, Coaches & Auctioneers
 Designed for audiences up to 1000 people
 15 lbs; Lightweight
 126 dB SPL from 22 watt amplifier
 1/4" line input, 1/4" line output, 1/4" speaker output
 Optional Single or Dual UHF wireless speakers
 Rechargeable Battery (10 Hrs per charge)
 6 Year Warranty, 110/220 Power Supply
 Each wireless channel has 16 frequencies built in



Description	List	Sale
MegaVox MEGA8000U1 Pro Basic Unit w/Bluetooth, 1 Wireless receiver, SS550 Stand, WB8000 Body-Pack, HBM-TA4F Headset Mic	\$1556	\$1264
MegaVox MEGA8000U2 Pro Dual Basic Unit w/Bluetooth, 2 Wireless receivers, SS550 Stand, WB8000 Body-Pack, HBM-TA4F Headset Mic (2 Ea)	\$2156	\$1744
MegaVox MEGA8001U1 Pro Deluxe Unit w/Bluetooth, 1 Wireless receiver, MEGA8001 Companion speaker, SC50 Connection cable, 2) SS550 Stands, WB8000 Body-Pack, HBM-TA4F Headset Mic	\$2001	\$1620
MegaVox MEGA8001U2 Pro Dual Deluxe Unit w/Wireless receiver, MEGA8001 Companion speaker, SC50 Connection cable, 2) SS550 Stands, WB8000 Body-Pack, HBM-TA4F Headset Mic (2 Ea)	\$2601	\$2100



Lectrosonics Long Ranger Replacement Headsets

HM162MC Over Ear Mic Headset
 Lightweight, noise cancelling design. To be used with high output PA systems. Adjustable lightweight headband provides comfortable fit. Over the ear design allows a cap or hat to be worn without interfering with microphone.

\$144



Yamaha Bass Drum Rim Saver

Pair. Protects rims from future shot damage. Enhances rimshot sounds. Easy installation.

RS1418 fits 14" & 18" Bass Drums
RS2032 fits 20" to 32" Bass Drums

\$28



Pearl Bass Drum Rim Shooter BDR-1

Clamp on hoop protector.

\$18



Pearl Bass Mallet Holder

BMH100 Bass mallet holder with built-in rim shooters.

\$55

Zildjian Zmac Cymbals

Pair; Multi-Application. Full, High, Bright & Rich in Harmonic Structure. Cymbal weight varies.

Model	Description	List	Sale
0471	14" Medium Heavy	\$582	\$339.95
0475	16" Medium Heavy	\$704	\$399.95
0477	18" Medium	\$832	\$479.95
0479 *	20" Medium	\$952	\$549.95

* Cymbals Ordered From Factory. Delivery 2-4 Weeks

Zildjian Sheet Bronze Band Cymbals

Pair. Sheet Bronze Metal.
 Good tone & quality at affordable prices.

Model	List	Sale
ZBT14BP 14"	\$212	\$119.95
ZBT16BP 16"	\$278	\$149.95
ZHT18BP 18"	\$466	\$259.95



Zildjian Stadium Cymbals

Pair. Designed for Contemporary Drum Corps & Marching Bands. Brilliant top finish, Traditional bottom finish.

Medium Weight

Model	List	Sale
0452 14"	\$582	\$339.95
0468 16"	\$704	\$399.95
0483 18"	\$832	\$479.95
0485 20" *	\$952	\$549.95

Medium Heavy Weight

Model	List	Sale
0487 16"	\$704	\$399.95
0495 18"	\$832	\$479.95
0497 20" *	\$952	\$549.95

* Cymbals Ordered From Factory. Delivery 2-4 Weeks



Neotech Saxophone Harness

NESH Comfortable and functional. Carries the burden of a heavy instrument. Allows player a full range of movement. Strong and durable. Spring loaded swivel clip for security. Extra-long model adjusts from 18" to 22.5". Ideal for bari saxes. Basic concert black.

\$25

Neotech Tuba Harness

THRBK Fully adjustable, conforms to shape of body. Evenly disperses instrument weight. 22" - 27" from top of shoulder to connector hooks where either the cradle or loops attach to main harness. Two connections: cradles lower section of tuba or loop connectors that attach to eyelet on lower section. Also has added upper support strap for added stability.



\$40



Yamaha Marching Tuba Shield

YMA-TBP Designed for YBB202M. Provides protection from damaging blows on and off field. Universal fit for most tubas. Heavy gauge plastic and high density foam with lightweight, durable corduroy nylon cover. Nylon straps & plastic clips keep shield in place. List \$124.99

\$70



Universal Sousa Protecto Pads

SPP Set/2 pads. Foam padded carriage and shoulder pads. Carriage pad protects the bottom bow from dents & scratches. Shoulder pad adds comfort to the player's shoulder and protects the finish. List \$135

SPP11 White

\$77 Pad Set

SPP21 Black

Sousaphone Neck & Bits

Clear Lacquer finish neck & bits.

Photo	Brand	Neck	Bits Set of 2
A	Buescher (Conn Style) Conn (All Models) Pan American (Conn Style)	\$80	\$45
B	King (Older Models)	\$80	\$45
C	King (New Style)	\$80	\$45
D	Olds / Reynolds	\$80	\$45
E	Signet / Buescher / Bundy	\$85	\$80
F	Holton	\$85	\$80
G	Jupiter	\$75	\$70
H	Yamaha	\$95	\$105
	--- Silver Finish, ADD	\$30	\$25

*Specify brand with order.

A



B



C



D



E



F



G



H



Sousaphone Pouch

SP10 Cloth pouch with zipper closure, 3 inside pockets to hold sousaphone mouthpipe, tuning bits & mouthpiece.



\$13 Each

\$33 Set of 3



Universal Brass Mouthpieces

Silver plated, medium cup.

Instrument	Model	Size	Sale
Cornet	UN-CO-7C	7C	\$18
Trumpet	UN-TP-3C	3C	\$18
Trumpet	UN-TP-7C	7C	\$18
French Horn	UN-FH-11	11	\$19
Mrchg Mellophone	ME6V	6	\$25
Trombone, Tenor	UN-TB-12C	12C	\$25
Trombone, Tenor	UN-ET-65AL	6.5AL	\$33
Trombone, Bass	UN-EB-65AL	6.5AL	\$33
Tuba/Sousa	UN-TU-24AW	24AW	\$45

Yamaha Mouthpieces

Molded plastic. Standard medium facing. Well balanced clear and focused tone. Ideal for beginner or professional player.

Instrument	Model	List	Sale
Bb Clarinet	YAC-12664C	\$55.99	\$30
Bass Clarinet	YAC-12764C	\$61.99	\$35
Alto Sax	YAC-12864C	\$46.99	\$25
Tenor Sax	YAC-12914C	\$48.99	\$27
Bari Sax	YAC-12955C	\$77.99	\$43



Deg Marching Lyres

\$10 Each
\$99 Dozen Any Mix



Model	Description
HC225	Flutist Friend Mounts on players forearm, complete with plastic backing, 5 music windows & plastic rings.
HC240	Drummer's Delight Snare Mounts directly on snare drum, remove tension screw, put screw through hole in base then return screw to drum. 5 music windows & plastic rings.
HC245	Marching Bass Drum Mounts directly on top of bass through tension rod. 5 music windows & plastic rings.
HC260	Marching Trumpet Clamps directly on trumpet bell, plastic coated clips. 5 music windows & plastic rings.
HC250	Marching Trombone Lyre Clips on side of bell closest to slide, plastic coated clamps. 5 music windows & plastic rings.

Marching Metal Lyres

Designed to fit any brand instrument.

Model	Description	Price
500LG	Low Brass (Straight) (Short 5 3/8" Stem)	\$5
500XLG	Low Brass (Straight) (Long 8.5" Stem)	\$5
501G	Trumpet (Bent Stem)	\$5
506N	Clarinet (with Ring)	\$5
517G	Saxophone	\$5
514G	Trombone (2 Pc Reg Bore)	\$5

\$55 Dozen - Any Mix

Model	Description	Price
502N	Trumpet (Clamp-on)	\$9
513N	Flute (Clamp-on)	\$10
515G	Trombone (2 Pc Lg Bore)	\$10

\$66 Dozen - Any Mix



Zildjian Cymbal Pads & Straps

Model	Description (Pair)	Sale
P0751	Black Leather Pads	\$18
P0753	Soft Wool Pads	\$24
P0750	Black Leather Straps	\$15
P0750/P0751	Black Leather Pads & Straps	\$33
P0750/P0753	Wool Pads & Leather Straps	\$33



Ludwig Sling Shot Cymbal Holder

L1392 Pair Sling Shot Grips pouch and ball design allows for simple assembly as they eliminate having to do any tying.

\$18

Bargain Cave **BLOWOUT**

www.taylormusic.com

**click on bargain cave
or call us at 1-800-872-2263**

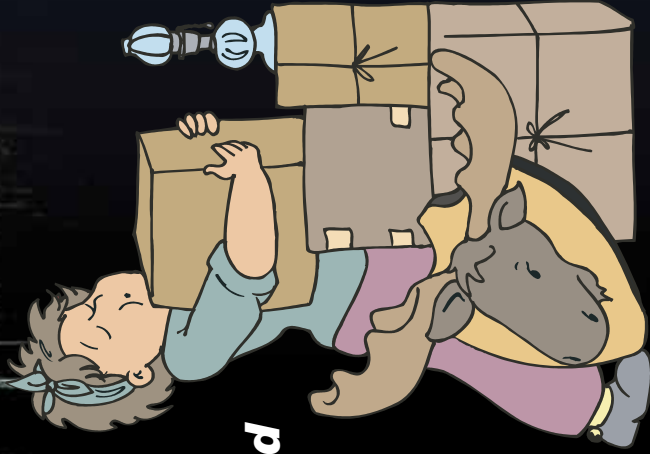

**Prices slashed
and
Quantities limited**

**When they are
gone...
they are gone**

Scan with your phone



Taylor Music
www.taylormusic.com
513 S. Main St.
Aberdeen, SD 57401

PRSR1 STD
U.S. POSTAGE
PAID
Madison, SD
Permit #32