

TIPS VENDOR AGREEMENT

Between SOPA, Inc. and
(Company Name)

THE INTERLOCAL PURCHASING SYSTEM (TIPS)

For

PART 2 - RCSP 170801 Auditorium, Stadium, Field Seating, Bleachers and Installation Services

Part 1 Auditorium, Stadium, Field Seating, Bleachers Goods

General Information

The Vendor Agreement (“Agreement”) made and entered into by and between The Interlocal Purchasing System (hereinafter referred to as “TIPS” respectfully) a government cooperative purchasing program authorized by the Region 8 Education Service Center, having its principal place of business at 4845 US Hwy 271 North, Pittsburg, Texas 75686. This Agreement consists of the provisions set forth below, including provisions of all Attachments referenced herein. In the event of a conflict between the provisions set forth below and those contained in any Attachment, the provisions set forth shall control.

The vendor Agreement shall include and incorporate by reference this Agreement, the terms and conditions, special terms and conditions, any agreed upon amendments, as well as all of the sections of the Solicitation (RFP, RCSP, RFQ) as posted, including any addenda and the awarded vendor’s proposal. Once signed, if an awarded vendor’s proposal varies or is unclear in any way from the TIPS Agreement, TIPS, at its sole discretion, will decide which provision will prevail. Other documents to be included are the awarded vendor’s proposals, task orders, purchase orders and any adjustments which have been issued. If deviations are submitted to TIPS by the proposing vendor as provided by and within the solicitation process, this Agreement may be amended to incorporate any agreed deviations.

The following pages will constitute the Agreement between the successful vendors(s) and TIPS.

Definitions

PURCHASE ORDER is the TIPS Member’s approval providing the authority to proceed with the negotiated delivery order under the Agreement. Special terms and conditions as agreed to between the vendor and TIPS Member should be added as addendums or deleted from the PO. Items such as certificate of insurance, bonding requirements, small or disadvantaged business goals are examples of possible addenda.

Terms and Conditions

Freight

If applicable, all quotes to Members shall provide a line item for cost for freight or shipping regardless if there is a charge or not. If no charge for freight or shipping, indicate by stating "No Charge" or "\$0" or other similar indication. Shipping, delivery or freight charges shall be passed through at cost to the TIPS Member.

Customer Support

The Vendor shall provide timely and accurate customer support to TIPS Members. Vendors shall respond to such requests within one (1) working day after receipt of the request. Vendor shall provide training regarding products and services supplied by the Vendor unless otherwise clearly stated in writing at the time of purchase. (Unless training is a line item sold or packaged and must be purchased with product.)

Agreements

All Agreements and agreements between Vendors and TIPS Members shall strictly adhere to all applicable statutes and codes.

Agreements for purchase will normally be put into effect by means of a purchase order(s) or other similar document or contract executed by authorized agent(s) of the purchasing TIPS Member.

Davis Bacon Act requirements will be met for construction and/or repair of buildings unless otherwise agreed with the TIPS Member.

Tax exempt status

A taxable item sold, leased, rented to, stored, used, or consumed by any of the following governmental entities is exempted from the taxes imposed by this chapter: (1) the United States; (2) an unincorporated instrumentality of the United States; (3) a corporation that is an agency or instrumentality of the United States and is wholly owned by the United States or by another corporation wholly owned by the United States; (4) the State of Texas; (5) a Texas county, city, special district, or other political subdivision; or (6) a state, or a governmental unit of a state that borders Texas, but only to the extent that the other state or governmental unit exempts or does not impose a tax on similar sales of items to this state or a political subdivision of this state. Texas Tax Code § 151.309.

Assignments of Agreements

No assignment of Agreement may be made without the prior written approval of TIPS. Payment made by a TIPS Member can only be made to the awarded Vendor or vendor assigned dealer.

Disclosures

1. Vendor affirms that he/she has not given, offered to give, nor intends to give at any time hereafter any economic opportunity, future employment, gift, loan, gratuity, special discount, trip, favor or service to a public servant in connection with this Agreement.

2. Vendor shall attach, in writing, a complete description of any and all relationships that might be considered a conflict of interest in doing business with TIPS under a TIPS Agreement.
3. The vendor affirms that, to the best of his/her knowledge, the offer has been arrived at independently, and is submitted without collusion with anyone to obtain information or gain any favoritism that would in any way limit competition or give an unfair advantage over other vendors in the award of this Agreement.

Renewal of Agreements

The Agreement with TIPS is for three (3) years with an option for renewal for additional one (1) consecutive year as provided in the related solicitation as specified on page one of this agreement. Total term of Agreement can be up to the number of years provided in the solicitation. The renewal option for the one additional year is at the agreement of the parties.

Automatic Renewal Clauses Incorporated in Awarded Vendor Agreements with TIPS Members Resulting from the Solicitation and with the Vendor Named in this Agreement.

NO AGREEMENT FOR GOODS OR SERVICES WITH A TIPS MEMBER BY THE AWARDED VENDOR NAMED IN THIS AGREEMENT THAT RESULTS FROM THE SOLICITATION AWARD NAMED IN THIS AGREEMENT, MAY INCORPORATE AN AUTOMATIC RENEWAL CLAUSE WITH WHICH THE TIPS MEMBER MUST COMPLY. ALL RENEWAL TERMS INCORPORATED IN AN AGREEMENT BY THE VENDOR WITH THE TIPS MEMBER SHALL ONLY BE VALID AND ENFORCEABLE WHEN THE VENDOR RECEIVES WRITTEN CONFIRMATION BY PURCHASE ORDER OR EXECUTED AGREEMENT ISSUED BY THE TIPS MEMBER FOR ANY RENEWAL PERIOD. THE PURPOSE OF THIS CLAUSE IS TO AVOID A TIPS MEMBER INADVERTENTLY RENEWING AN AGREEMENT DURING A PERIOD IN WHICH THE GOVERNING BODY OF THE TIPS MEMBER HAS NOT PROPERLY APPROPRIATED AND BUDGETED THE FUNDS TO SATISFY THE AGREEMENT RENEWAL. THIS TERM IS NOT NEGOTIABLE AND ANY AGREEMENT BETWEEN A TIPS MEMBER AND A TIPS AWARDED VENDOR WITH AN AUTOMATIC RENEWAL CLAUSE THAT CONFLICTS WITH THESE TERMS IS RENDERED VOID AND UNENFORCEABLE AS TO THE AUTOMATIC RENEWAL CLAUSE.

Shipments (If Applicable)

The Vendor shall ship ordered products within a commercially reasonable time after the receipt of the order. If a product cannot be shipped within that time, the Vendor shall notify TIPS and the TIPS Member as to why the product has not shipped and shall provide an estimated shipping date, if applicable. TIPS or the TIPS Member may cancel the order if estimated shipping time is not acceptable.

Invoices

The Vendor or, if applicable, the vendor assigned dealer shall submit invoices, to the TIPS Member. Each invoice shall include the TIPS Member's purchase order number. The shipment

tracking number or pertinent information for verification of TIPS Member receipt shall be made available upon request. The Vendor or vendor assigned dealer shall not invoice for partial shipments unless agreed to in writing in advance by TIPS or the TIPS Member.

Payments

The TIPS Member will make payments directly to the Vendor or vendor assigned dealer as agreed by the TIPS Member.

Pricing

The Vendor agrees to provide pricing to TIPS and TIPS Member entities that is at least equal to the lowest pricing available from the vendor to like cooperative purchasing customers in like situations and the pricing shall remain so throughout the duration of the Agreement.

All pricing submitted to TIPS shall include the participation fee, as designated in the solicitation or as otherwise agreed in writing, to be remitted to TIPS by the Vendor. Vendor shall not show adding the fee to the invoice presented to TIPS Member customer. Failure to render the participation fee to TIPS shall constitute a breach of this agreement and shall be grounds for termination of this agreement and any other agreement held with TIPS.

Participation Fees

Vendor or vendor assigned dealer agrees to pay TIPS on a monthly scheduled report the participation fee for all Agreement sales to TIPS Members utilizing a TIPS awarded contract. Vendor must login to the TIPS database and use the "Submission Report" section to report sales. The Vendor or vendor assigned dealers are responsible for keeping records of all sales that go through the TIPS Agreement. Failure to pay the participation fee will result in termination of Agreement. Please contact TIPS at tips@tips-usa.com or call (866) 839-8477 if you have questions about paying fees.

Indemnity

- 2. Indemnity for Personality Agreements.** Vendor agrees to indemnify and hold harmless and defend TIPS, TIPS Member(s), officers and employees, from and against all claims and suits for damages, injuries to persons (including death), property damages, losses, and expenses including court costs and attorney's fees, arising out of, or resulting from, Vendor's performance of this Agreement or sales made to TIPS Members under this agreement, including all such causes of action based upon common, constitutional, or statutory law, or based in whole or in part, upon allegations of negligent or intentional acts on the part of the Vendor, its officers, employees, agents, subcontractors, licensees, invitees, unless such claims are based in whole upon the negligent acts or omissions of the TIPS, TIPS Member(s), officers, employees, or agents. If based in part upon the negligent acts or omissions of the TIPS, TIPS Member(s), officers, employees, or agents, Vendor shall be responsible for their proportional share of the claim.

2. **Indemnity for Performance Agreements.** The Vendor agrees to indemnify and hold harmless and defend TIPS, TIPS Member(s), officers and employees from and against all claims and suits for damages, injuries to persons (including death), property damages, losses, and expenses including court costs and attorney's fees, arising out of, or resulting from, Vendor's work under this Agreement, including all such causes of action based upon common, constitutional, or statutory law, or based in whole or in part, upon allegations of negligent or intentional acts on the part of the Vendor, its officers, employees, agents, subcontractors, licensees, or invitees, unless such claims are based in whole upon the negligent acts or omissions of the TIPS, TIPS Member(s), officers, employees, or agents. If based in part upon the negligent acts or omissions of the TIPS, TIPS Member(s), officers, employees, or agents, Vendor shall be responsible for their proportional share of the claim.

State of Texas Franchise Tax

By signature hereon, the bidder hereby certifies that he/she is not currently delinquent in the payment of any franchise taxes owed the State of Texas under Chapter 171, Tax Code.

Miscellaneous

Nothing in the Agreement or in any other communication between TIPS and the Vendor may be construed as a guarantee that TIPS Members will submit any orders at any time. TIPS reserves the right to request additional proposals for items already on Agreement at any time.

Purchase Order Pricing/Product Deviation

If a deviation of agreed pricing/product on a purchase order from a TIPS Member pursuant to this Agreement occurs, TIPS shall be notified within 48 hours of receipt of order.

Termination for Convenience

TIPS reserves the right to terminate this agreement for cause or no cause for convenience with a thirty-day written notice. Termination for convenience is required under Federal Regulations 2 CFR part 200. All purchase orders presented to the Vendor by a TIPS Member prior to the actual termination of this agreement shall be honored at the option of the TIPS Member. The awarded vendor may terminate the agreement with ninety (90) days written notice to TIPS 4845 US Hwy North, Pittsburg, Texas 75686.

TIPS Member Purchasing Procedures

Purchase orders or their equal are issued by participating TIPS Member to the awarded vendor indicating on the PO "TIPS Agreement Number". Order is emailed to TIPS at tipspo@tips-usa.com.

- Awarded vendor delivers goods/services directly to the participating Member.
- Awarded vendor invoices the participating TIPS Member directly.
- Awarded vendor receives payment directly from the participating Member.
- Awarded vendor reports sales monthly to TIPS (unless prior arrangements have been made with TIPS to report otherwise).

Supplemental Agreements

The TIPS Member and awarded vendor may enter into a separate supplemental agreement to further define the level of service requirements over and above the minimum defined in this Agreement i.e. invoice requirements, ordering requirements, specialized delivery, etc. Any supplemental agreement developed as a result of this Agreement is exclusively between the participating entity and awarded vendor. TIPS, its agents, TIPS Members and employees shall not be made party to any claim for breach of such agreement.

INDEMNITY UNDER A SUPPLEMENTAL AGREEMENT:

ANY SUPPLEMENTAL AGREEMENT BETWEEN THE TIPS OR A TIPS MEMBER AND THE VENDOR THAT REQUIRES TIPS OR THE TIPS MEMBER TO INDEMNIFY ANY OTHER PARTY, EXCEPT TO THE EXTENT PERMITTED BY THE APPLICABLE CONSTITUTION, LAWS OR REGULATIONS OF THE JURISDICTION OF THE LOCATION OF THE TIPS MEMBER OR THE LOCATION OF THE PERFORMANCE OF THE CONTRACT UNDER THIS AGREEMENT, IS NOT PERMITTED UNDER THIS AGREEMENT AND RENDERS THE INDEMNITY REQUIREMENT NULL AND VOID AS IT APPLIES TO TIPS OR THE TIPS MEMBER'S RESPONSIBILITY TO INDEMNIFY ANY PARTY.

Licenses

Awarded vendor shall maintain, in current status, all federal, state and local licenses, bonds and permits required for the operation of the business conducted by awarded vendor. Awarded vendor shall remain fully informed of and in compliance with all ordinances and regulations pertaining to the lawful provision of services under the Agreement. TIPS reserves the right to stop work and/or cancel Agreement of any awarded vendor whose license(s) expire, lapse, are suspended or terminated.

Novation

If awarded vendor sells or transfers all assets or the entire portion of the assets used to perform this Agreement, a successor in interest must guarantee to perform all obligations under this Agreement. TIPS reserves the right to accept or reject assignment of this agreement. A simple change of name agreement will not change the Agreement obligations of awarded vendor.

Site Requirements (Only when applicable to service or job)

Cleanup: Awarded vendor shall clean up and remove all debris and rubbish resulting from their work as required or directed by TIPS Member. Upon completion of work, the premises shall be left in good repair and an orderly, neat, clean and unobstructed condition.

Preparation: Awarded vendor shall not begin a project for which TIPS Member has not prepared the site, unless awarded vendor does the preparation work at no cost, or until TIPS Member includes the cost of site preparation in a purchase order.

Site preparation includes, but is not limited to: moving furniture, installing wiring for networks or power, and similar pre-installation requirements.

Registered sex offender restrictions: For work to be performed at schools, awarded vendor agrees that no employee of a sub-contractor who has been adjudicated to be a registered sex offender will perform work at any time when students are or reasonably expected to be present. Awarded vendor agrees that a violation of this condition shall be considered a material breach and may result in the cancellation of the purchase order at the TIPS Member's discretion. Awarded vendor must identify any additional costs associated with compliance of this term. If no costs are specified, compliance with this term will be provided at no additional charge.

Safety measures: Awarded vendor shall take all reasonable precautions for the safety of employees on the worksite, and shall erect and properly maintain all necessary safeguards for protection of workers and the public. Awarded vendor shall post warning signs against all hazards created by the operation and work in progress. Proper precautions shall be taken pursuant to state law and standard practices to protect workers, general public and existing structures from injury or damage.

Smoking

Persons working under Agreement shall adhere to local smoking policies. Smoking will only be permitted in posted areas or off premises.

Invoices

The awarded vendor shall submit invoices to the TIPS Member clearly stating "Per TIPS Agreement". The shipment tracking number or other applicable pertinent information for verification shall be made available upon request.

Marketing

Awarded vendor agrees to allow TIPS to use their name and logo within the TIPS website, marketing materials and advertisement. Any use of TIPS name and logo or any form of publicity, inclusive of press release, regarding this Agreement by awarded vendor must have prior approval from TIPS and approval of which, shall not be unreasonably withheld by TIPS.

Survival Clause

All applicable software license agreements, warranties or service agreements that were entered into between Vendor and Customer under the terms and conditions of the Agreement shall survive the expiration or termination of the Agreement. All Orders, Purchase Orders issued or contracts executed by TIPS or a TIPS Member and accepted by the Vendor prior to the expiration or termination of this agreement, shall survive expiration or termination of the Agreement, subject to previously agreed terms and conditions agreed by the parties or as otherwise specified herein relating to termination of this agreement.

Legal obligations

It is the responding vendor's responsibility to be aware of and comply with all local, state and federal laws governing the sale of products/services identified in this RFP and any awarded Agreement thereof. Applicable laws and regulations must be followed even if not specifically identified herein.

Audit rights

Awarded Vendor shall, at their sole expense, maintain appropriate due diligence of all purchases made by TIPS Member that utilizes this Agreement. TIPS and Region 8 ESC each reserve the right to audit the accounting for a period of three (3) years from the time such purchases are made. This audit right shall survive termination of this Agreement for a period of three (3) years from the effective date of termination. TIPS shall have authority to conduct random audits of Awarded Vendor's pricing that is offered to TIPS Members. Notwithstanding the foregoing, in the event that TIPS is made aware of any pricing being offered to eligible entities that is materially inconsistent with the pricing under this agreement, TIPS shall have the ability to conduct the audit internally or may engage a third-party auditing firm. In the event of an audit, the requested materials shall be provided in the format and at the location designated by Region 8 ESC or TIPS. TIPS shall bear the cost of such audit requested by TIPS, but all documents maintained by the vendor shall be produced and made available to TIPS or its agents at no cost.

Force Majeure

If by reason of Force Majeure, either party hereto shall be rendered unable wholly or in part to carry out its obligations under this Agreement then such party shall give notice and fully particulars of Force Majeure in writing to the other party within a reasonable time after occurrence of the event or cause relied upon, and the obligation of the party giving such notice, so far as it is affected by such Force Majeure, shall be suspended during the continuance of the inability then claimed, except as hereinafter provided, but for no longer period, and such party shall endeavor to remove or overcome such inability with all reasonable dispatch.

Acceptance of work by TIPS Member

When a Vendor performs services for a TIPS Member, the TIPS Member will inspect the work for acceptance under the scope and terms in the PO. The TIPS Member will request any corrective actions that are required. Upon completion of these actions and not before, the TIPS Member will be obligated to compensate the Vendor as agreed.

Support Requirements

If there is a dispute between the awarded vendor and TIPS Member, TIPS or its representatives will assist in conflict resolution or third party (mandatory mediation), if requested by either party. TIPS, or its representatives, reserves the right to inspect any project and audit the awarded vendors TIPS project files, documentation and correspondence.

Bonding

Only when applicable, performance bonds and payment bonds will be required on construction or labor required jobs. Awarded vendor will meet the TIPS member's local and state purchasing requirements. Awarded vendors may need to provide additional capacity as jobs increase. Bonds will not require that a fee be paid to TIPS. The actual cost of the bond will be a pass through to the TIPS member and added to the purchase order or Agreement.

Incorporation of Solicitation

The TIPS Solicitation, Request for Proposals, Request for Qualifications or the Request for Competitive Sealed Proposals solicitation and all associated documents and forms made part of the solicitation process, including any addenda, that resulted in the execution of this agreement are hereby incorporated by reference into this agreement as if copied verbatim.

Scope of Services

The specific scope of work for each job shall be determined in advance and in writing between TIPS Member and Awarded vendor. It is okay if the TIPS member provides a general scope, but the awarded vendor should provide a written scope of work to the TIPS member as part of the proposal. Once the scope of the job is agreed to, the TIPS member will issue a PO and/or an Agreement with the estimate referenced as an attachment along with bond and any other special provisions agreed to for the TIPS member. If special terms and conditions other than those covered within this solicitation and awarded Agreements are required, they will be attached to the PO and shall take precedence over those in the base Agreement.

Project Delivery Order Procedures

The TIPS member having approved and signed an interlocal agreement, or other TIPS membership document, may make a request of the awarded vendor under this Agreement when the TIPS member has services that need to be undertaken. Notification may occur via phone, the web, email, fax, or in person.

Upon notification of a pending request, the awarded vendor shall make contact with the TIPS member as soon as possible, but must make contact with the TIPS member within two working days.

Scheduling of Construction Projects (when applicable)

Scheduling of projects (if applicable) will be accomplished when the TIPS member issues a purchase order that will serve as "the notice to proceed". The period for the delivery order will include the mobilization, materials purchase, installation and delivery, design, weather, and site cleanup and inspection. No additional claims may be made for delays as a result of these items. When the tasks have been completed the awarded vendor shall notify the client and have the TIPS member inspect the work for acceptance under the scope and terms in the PO. The TIPS member will issue in writing any corrective actions that are required. Upon completion of these items, the TIPS member will issue a completion notice and final payment will be issued.

Special Terms and Conditions

It is the intent of TIPS to Agreement with a reliable, high performance vendor to supply products and services to government and educational agencies. It is the experience of TIPS that the following procedures provide TIPS, the Vendor, and the participating agency the necessary support to facilitate a mutually beneficial relationship. The specific procedures will be negotiated with the successful vendor.

- **Agreements:** All orders made by TIPS Members to the awarded vendor must be emailed to TIPS at tipspo@tips-usa.com. Should a TIPS Member send an order direct to vendor, it is the vendor's responsibility to forward the order to TIPS at the email above within three (3) business days and confirm its receipt with TIPS.
 - **Promotion of Agreement:** It is agreed that Vendor will encourage all eligible entities to purchase from the TIPS Program. Encouraging entities to purchase directly from the Vendor and not through TIPS Agreement is a breach of this agreement terms and conditions and will result in termination and rescission of this agreement and removal of the Vendor from the TIPS Program.
 - **Daily Order Confirmation:** All Agreement purchase orders will be approved daily by TIPS and sent to vendor. The vendor must confirm receipt of orders to the TIPS Member (customer) within two (2) business days.
 - **Vendor custom website for TIPS:** If Vendor is hosting a custom TIPS Agreement catalog website, then any updated pricing must be posted by 1st of each month. Any increase in a "catalog" price, as defined herein, is not effective until it is published in the vendor's "catalog" as defined herein.
 - **Back Ordered Products:** If product is not expected to ship within 7 business days, customer is to be notified within 24 hours of order receipt and appropriate action taken based on customer request.
-

Page 11 of 11 will be the TIPS Vendor Agreement Signature Page

TIPS Vendor Agreement Signature Form

RFP 170801 Part 1 - Auditorium Seating and or Bleachers and Installation Services

Company Name SOPA, Inc.

Address 2323 Cantrell Rd.

City Little Rock State AR Zip 72202

Phone 501-663-5500 Fax 501-663-5508

Email of Authorized Representative scott@sopainc.com

Name of Authorized Representative Scott Greene

Title Vice President

Signature of Authorized Representative 

Date 09/13/17

TIPS Authorized Representative Name Meredith Barton

Title Vice-President of Operations

TIPS Authorized Representative Signature 

Approved by ESC Region 8 

Date 10/24/17

The Interlocal Purchasing System (TIPS Cooperative) Supplier Response

Bid Information		Contact Information		Ship to Information
Bid Creator	Rick Powell General Counsel/Procurement Compliance Officer	Address	Region VIII Education Service Center 4845 US Highway 271 North Pittsburg, TX 75686	Address
Email	rick.powell@tips-usa.com	Contact	Kristie Collins, Contracts Compliance Specialist	Contact
Phone	(903) 575-2689			Department Building
Fax				Floor/Room Telephone Fax Email
Bid Number	170801	Department Building		
Title	Auditorium, Stadium, Field Seating, Bleachers and Installation Services			
Bid Type	RFP			
Issue Date	8/3/2017 03:00 PM (CT)	Floor/Room		
Close Date	9/15/2017 03:00:00 PM (CT)	Telephone	+1 (866) 839-8477	
		Fax	+1 (866) 839-8472	
		Email	bids@tips-usa.com	

Supplier Information

Company	SOPA, Inc. (School and Office Products of Arkansas)
Address	PO Box 26015 Little Rock, AR 72221
Contact	
Department	
Building	
Floor/Room	
Telephone	(501) 663-5500
Fax	(501) 663-5508
Email	
Submitted	9/14/2017 02:33:57 PM (CT)
Total	\$0.00

By submitting your response, you certify that you are authorized to represent and bind your company.

Signature Scott Greene

Email scott@sopainc.com

Supplier Notes

Bid Notes

Bid Activities

Bid Messages

Bid Attributes

Please review the following and respond where necessary

#	Name	Note	Response
1	Yes - No	Disadvantaged/Minority/Women Business Enterprise - D/M/WBE (Required by some participating governmental entities) Vendor certifies that their firm is a D/M/WBE? Vendor must upload proof of certification to the "Response Attachments" D/M/WBE CERTIFICATES section.	No
2	Yes - No	Historically Underutilized Business - HUB (Required by some participating governmental entities) Vendor certifies that their firm is a HUB as defined by the State of Texas at https://comptroller.texas.gov/purchasing/vendor/hub/ or in a HUBZone as defined by the US Small Business Administration at https://www.sba.gov/offices/headquarters/ohp Proof of one or both may be submitted. Vendor must upload proof of certification to the "Response Attachments" HUB CERTIFICATES section.	No
3	Yes - No	The Vendor can provide services and/or products to all 50 US States?	No
4	States Served:	If answer is NO to question #3, please list which states can be served. (Example: AR, OK, TX)	AR, OK, MS
5	Company and/or Product Description:	This information will appear on the TIPS website in the company profile section, if awarded a TIPS contract. (Limit 750 characters.)	SOPA, Inc. provides consulting, sales, and installation for any seating project whether it is indoors or outdoors.
6	Primary Contact Name	Primary Contact Name	Scott Greene
7	Primary Contact Title	Primary Contact Title	Vice President
8	Primary Contact Email	Primary Contact Email	scott@sopainc.com
9	Primary Contact Phone	Enter 10 digit phone number. (No dashes or extensions) Example: 8668398477	501-663-5500
10	Primary Contact Fax	Enter 10 digit phone number. (No dashes or extensions) Example: 8668398477	501-663-5508
11	Primary Contact Mobile	Enter 10 digit phone number. (No dashes or extensions) Example: 8668398477	501-413-1933
12	Secondary Contact Name	Secondary Contact Name	Terry Greene
13	Secondary Contact Title	Secondary Contact Title	President
14	Secondary Contact Email	Secondary Contact Email	terry@sopainc.com
15	Secondary Contact Phone	Enter 10 digit phone number. (No dashes or extensions) Example: 8668398477	501-663-5500
16	Secondary Contact Fax	Enter 10 digit phone number. (No dashes or extensions) Example: 8668398477	501-663-5508
17	Secondary Contact Mobile	Enter 10 digit phone number. (No dashes or extensions) Example: 8668398477	501-681-1300

18	Admin Fee Contact Name	Admin Fee Contact Name. This person is responsible for paying the admin fee to TIPS.	Jeannette Jacobe
19	Admin Fee Contact Email	Admin Fee Contact Email	jeannette@sopainc.com
20	Admin Fee Contact Phone	Enter 10 digit phone number. (No dashes or extensions) Example: 8668398477	501-663-5500
21	Purchase Order Contact Name	Purchase Order Contact Name. This person is responsible for receiving Purchase Orders from TIPS.	Jeannette Jacobe
22	Purchase Order Contact Email	Purchase Order Contact Email	jeannette@sopainc.com
23	Purchase Order Contact Phone	Enter 10 digit phone number. (No dashes or extensions) Example: 8668398477	5016635500
24	Company Website	Company Website (Format - www.company.com)	www.sopainc.com
25	Federal ID Number:	Federal ID Number also known as the Employer Identification Number. (Format - 12-3456789)	62-1668176
26	Primary Address	Primary Address	2323 Cantrell Rd.
27	Primary Address City	Primary Address City	Little Rock
28	Primary Address State	Primary Address State (2 Digit Abbreviation)	AR
29	Primary Address Zip	Primary Address Zip	72202
30	Search Words:	Please list search words to be posted in the TIPS database about your company that TIPS website users might search. Words may be product names, manufacturers, or other words associated with the category of award. YOU MAY NOT LIST NON-CATEGORY ITEMS. (Limit 500 words) (Format: product, paper, construction, manufacturer name, etc.)	Bleachers, seating, team seating, telescopic bleachers, retractable seating, stadium seating, auditorium seating, theater seating, sports seating, gym seating, lecture room seating
31	Yes - No	Most of our members receive Federal Government grants and they make up a significant portion of their budgets. The members need to know if your company is willing to sell to them when they spend federal budget funds on their purchase. There are attributes that follow that are provisions from the federal regulations in 2 CFR part 200. Your answers will determine if your award will be designated as Federal or Education Department General Administrative Regulations (EDGAR)compliant. Is it your intent to be able to sell to our members regardless of the fund source, whether it be local, state or federal?	Yes
32	Yes - No	Certification of Residency (Required by the State of Texas) The vendor's ultimate parent company or majority owner: (A) has its principal place of business in Texas; OR (B) employs at least 500 persons in Texas?	No
33	Company Residence (City)	Vendor's principal place of business is in the city of?	Little Rock
34	Company Residence (State)	Vendor's principal place of business is in the state of?	AR

35 Felony Conviction Notice:	<p>(Required by the State of Texas) My firm is, as outlined on PAGE 5 in the Instructions to Bidders document: (Questions 36 - 37) Statutory citation covering notification of criminal history of contractor is found in the Texas Education Code #44.034.</p> <p>Following is an example of a felony conviction notice: State of Texas Legislative Senate Bill No. 1, Section 44.034, Notification of Criminal History, Subsection (a), states "a person or business entity that enters into a contract with a school district or ESC 8/TIPS must give advance notice to the district or ESC 8/TIPS if the person or an owner or operator of the business entity has been convicted of a felony.</p> <p>The notice must include a general description of the conduct resulting in the conviction of a felony." Subsection (b) states "a school district may terminate a contract with a person or business entity if the district determines that the person or business entity failed to give notice as required by Subsection (a) or misrepresented the conduct resulting in the conviction. The district must compensate the person or business entity for services performed before the termination of the contract."</p>	(No Response Required)
36 Yes - No	A publicly held corporation; therefore, this reporting requirement is not applicable?	No
37 Yes - No	Is owned or operated by individual(s) who has/have been convicted of a felony?	No
38 If your firm is owned or operated by the following individual(s) who has/have been convicted of a felony:	Please provide details of the conviction. This is not necessarily a disqualifying factor and the details of the conviction determines the eligibility. Providing false or misleading information about the conviction is illegal.	
39 Pricing Information:	Pricing information section. (Questions 39 - 43)	(No Response Required)
40 Discount Offered	What is the MINIMUM percentage discount off of any item or service you offer to TIPS Members that is in your regular catalog (as defined in the RFP document), website, store or shelf pricing? This is a ceiling on your pricing and not a floor because, in order to be more competitive in the individual circumstance, you may offer a larger discount depending on the items or services purchased and the quantity at time of sale. Must answer with a number between 0% and 100%.	15%
41 TIPS administration fee	By submitting a proposal, I agree that all pricing submitted to TIPS shall include the participation fee, as designated in the solicitation or as otherwise agreed in writing and shall be remitted to TIPS by the Vendor as agreed in the Vendor agreement. I agree that the fee shall not and will not be added by the vendor as a separate line item on a TIPS member invoice, quote, proposal or any other written communications with the TIPS member.	(No Response Required)
42 Yes - No	<p>Vendor agrees to remit to TIPS the required administration fee?</p> <p>TIPS/ESC Region 8 is required by Texas Government Code § 791 to be compensated for its work and thus, failure to agree shall render your response void and it will not be considered.</p>	Yes
43 Yes - No	Do you offer additional discounts to TIPS members for large order quantities or large scope of work?	Yes

44	Start Time	Average start time after receipt of customer order is ____ working days?	90
45	Years Experience	Company years experience in this category?	20
46	Resellers:	<p>Does the vendor have resellers that it will name under this contract? Resellers are defined as other companies that sell your products under an agreement with you, the awarded vendor of TIPS.</p> <p>EXAMPLE: Walmart is a reseller of Samsung Electronics. If Samsung were a TIPS awarded vendor, then Samsung would list Walmart as a reseller.</p> <p>(If applicable, vendor should download the Reseller/Dealers spreadsheet from the Attachments section, fill out the form and submit the document in the "Response Attachments" RESELLERS section.</p>	No
47	Prices are guaranteed for?	Vendor agrees to honor the pricing discount off regular catalog (as defined in the RFP document), website, store or shelf pricing for the term of the award?	YES
48	Right of Refusal	Does the proposing vendor wish to reserve the right not to perform under the awarded agreement with a TIPS member at vendor's discretion?	No
49	NON-COLLUSIVE BIDDING CERTIFICATE	<p>By submission of this bid or proposal, the Bidder certifies that:</p> <p>1) This bid or proposal has been independently arrived at without collusion with any other Bidder or with any Competitor;</p> <p>2) This bid or proposal has not been knowingly disclosed and will not be knowingly disclosed, prior to the opening of bids, or proposals for this project, to any other Bidder, Competitor or potential competitor;</p> <p>3) No attempt has been or will be made to induce any other person, partnership or corporation to submit or not to submit a bid or proposal;</p> <p>4) The person signing this bid or proposal certifies that he has fully informed himself regarding the accuracy of the statements contained in this certification, and under the penalties being applicable to the Bidder as well as to the person signing in its behalf. Not a negotiable term. Failure to agree will render your proposal non-responsive and it will not be considered.</p>	(No Response Required)
50	CONFLICT OF INTEREST QUESTIONNAIRE - FORM CIQ	<p>If you have a conflict of interest as described in this form or the Local Government Code Chapter 176, cited therein- you are required to complete and file with TIPS, Richard Powell, 4845 US Highway 271 North, Pittsburg, Texas 75686</p> <p>You may find the Blank CIQ form on our website at:</p> <p>Copy and Paste the following link into a new browser or tab: https://www.tips-usa.com/assets/documents/docs/CIQ.pdf</p> <p>Do you have any conflicts under this statutory requirement?</p>	No
51	Filing of Form CIQ	If yes (above), have you filed a form CIQ as directed here?	

- 52 Regulatory Standing I certify to TIPS for the proposal attached that my company is in good standing with all governmental agencies Federal or state that regulate any part of our business operations. If not, please explain in the next attribute question. Yes
- 53 Regulatory Standing Regulatory Standing explanation of no answer on previous question.
- 54 Antitrust Certification Statements (Tex. Government Code § 2155.005) By submission of this bid or proposal, the Bidder certifies that: (No Response Required)
- I affirm under penalty of perjury of the laws of the State of Texas that:
- (1) I am duly authorized to execute this contract on my own behalf or on behalf of the company, corporation, firm, partnership or individual (Company) listed below;
 - (2) In connection with this bid, neither I nor any representative of the Company has violated any provision of the Texas Free Enterprise and Antitrust Act, Tex. Bus. & Comm. Code Chapter 15;
 - (3) In connection with this bid, neither I nor any representative of the Company has violated any federal antitrust law;
 - (4) Neither I nor any representative of the Company has directly or indirectly communicated any of the contents of this bid to a competitor of the Company or any other company, corporation, firm, partnership or individual engaged in the same line of business as the Company.

Instructions for Certification:

1. By agreeing to the Attribute question #56, the vendor and prospective lower tier participant is providing the certification set out herein in accordance with these instructions.
2. The certification in this clause is a material representation of fact upon which reliance was placed when this transaction was entered into. If it is later determined that the prospective lower tier participant knowingly rendered an erroneous certification in addition to other remedies available to the federal government, the department or agency with which this transaction originated may pursue available remedies, including suspension and / or debarment.
3. The prospective lower tier participant shall provide immediate written notice to the person to which this proposal is submitted if at any time the prospective lower tier participant learns that its certification was erroneous when submitted or has become erroneous by reason of changed circumstances.
4. The terms "covered transaction," "debarred," "suspended," "ineligible," "lower tier covered transaction," "participants," "person," "primary covered transaction," "principal," "proposal" and "voluntarily excluded," as used in this clause, have the meanings set out in the Definitions and Coverage sections of rules implementing Executive Order 12549. You may contact the person to which this proposal is submitted for assistance in obtaining a copy of those regulations.
5. The prospective lower tier participant agrees by submitting this form that, should the proposed covered transaction be entered into, it shall not knowingly enter into any lower tier covered transaction with a person who is debarred, suspended, declared ineligible or voluntarily excluded from participation in this covered transaction, unless authorized by the department or agency with which this transaction originated.
6. The prospective lower tier participant further agrees by submitting this form that it will include this clause titled "Certification Regarding Debarment, Suspension, Ineligibility and Voluntary Exclusion-Lower Tier Covered Transaction" without modification in all lower tier covered transactions and in all solicitations for lower tier covered transactions.
7. A participant in a covered transaction may rely upon a certification of a prospective participant in a lower tier covered transaction that it is not debarred, suspended, ineligible or voluntarily excluded from the covered transaction, unless it knows that the certification is erroneous. A participant may decide the method and frequency by which it determines the eligibility of its principals. Each participant may, but is not required to, check the Nonprocurement List.
8. Nothing contained in the foregoing shall be construed to require establishment of a system of records in order to render in good faith the certification required by this clause. The knowledge and information of a participant is not required to exceed that which is normally possessed by a prudent person in the ordinary course of business dealings.
9. Except for transactions authorized under paragraph 5 of these instructions, if a participant in a covered transaction knowingly enters into a lower tier covered transaction with a person who is suspended, debarred, ineligible or voluntarily excluded from participation in this transaction, in addition to other remedies available to the federal government, the department or agency with which this

transaction originated may pursue available remedies, including suspension and / or debarment.

56 Suspension or Debarment Certification

Debarment and Suspension (Executive Orders 12549 and 12689)—A contract award (see 2 CFR 180.220) must not be made to parties listed on the governmentwide exclusions in the System for Award Management (SAM), in accordance with the OMB guidelines at 2 CFR 180 that implement Executive Orders 12549 (3 CFR part 1986 Comp., p. 189) and 12689 (3 CFR part 1989 Comp., p. 235), "Debarment and Suspension." SAM Exclusions contains the names of parties debarred, suspended, or otherwise excluded by agencies, as well as parties declared ineligible under statutory or regulatory authority other than Executive Order 12549.

By submitting this offer and certifying this section, this bidder:
Certifies that no suspension or debarment is in place, which would preclude receiving a federally funded contract as described above.

57 Non-Discrimination Statement and Certification

In accordance with Federal civil rights law, all U.S. Departments, including the U.S. Department of Agriculture (USDA) civil rights regulations and policies, the USDA, its Agencies, offices, and employees, and institutions participating in or administering USDA programs are prohibited from discriminating based on race, color, national origin, religion, sex, gender identity (including gender expression), sexual orientation, disability, age, marital status, family/parental status, income derived from a public assistance program, political beliefs, or reprisal or retaliation for prior civil rights activity, in any program or activity conducted or funded by USDA (not all bases apply to all programs). Remedies and complaint filing deadlines vary by program or incident. Persons with disabilities who require alternative means of communication for program information (e.g., Braille, large print, audiotope, American Sign Language, etc.) should contact the responsible Agency or USDA's TARGET Center at (202) 720-2600 (voice and TTY) or contact USDA through the Federal Relay Service at (800) 877-8339. Additionally, program information may be made available in languages other than English. To file a program discrimination complaint, complete the USDA Program Discrimination Complaint Form, AD-3027, found online at How to File a Program Discrimination Complaint and at any USDA office or write a letter addressed to USDA and provide in the letter all of the information requested in the form. To request a copy of the complaint form, call (866) 632-9992. Submit your completed form or letter to USDA by: (1) mail: U.S. Department of Agriculture, Office of the Assistant Secretary for Civil Rights, 1400 Independence Avenue, SW, Washington, D.C. 20250-9410; (2) fax: (202) 690-7442; or (3) email: program.intake@usda.gov. (Title VI of the Education Amendments of 1972; Section 504 of the Rehabilitation Act of 1973; the Age Discrimination Act of 1975; Title 7 CFR Parts 15, 15a, and 15b; the Americans with Disabilities Act; and FNS Instruction 113-1, Civil Rights Compliance and Enforcement – Nutrition Programs and Activities) All U.S. Departments, including the USDA are equal opportunity provider, employer, and lender.

Not a negotiable term. Failure to agree will render your

proposal non-responsive and it will not be considered. I certify that in the performance of a contract with TIPS or its members, that our company will conform to the foregoing anti-discrimination statement and comply with the cited and all other applicable laws and regulations.

58 2 CFR PART 200 Contract Provisions Explanation

Required Federal contract provisions of Federal Regulations for Contracts for contracts with ESC Region 8 and TIPS Members:

(No Response Required)

The following provisions are required to be in place and agreed if the procurement is funded in any part with federal funds.

The ESC Region 8 and TIPS Members are the subgrantee or Subrecipient by definition. Most of the provisions are located in 2 CFR PART 200 - Appendix II to Part 200—Contract Provisions for Non-Federal Entity Contracts Under Federal Awards at 2 CFR PART 200. Others are included within 2 CFR part 200 et al.

In addition to other provisions required by the Federal agency or non-Federal entity, all contracts made by the non-Federal entity under the Federal award must contain provisions covering the following, as applicable.

59 2 CFR PART 200 Contracts

Contracts for more than the simplified acquisition threshold currently set at \$150,000, which is the inflation adjusted amount determined by the Civilian Agency Acquisition Council and the Defense Acquisition Regulations Council (Councils) as authorized by 41 U.S.C. 1908, must address administrative, contractual, or legal remedies in instances where contractors violate or breach contract terms, and provide for such sanctions and penalties as appropriate. Notice: Pursuant to the above, when federal funds are expended by ESC Region 8 and TIPS Members, ESC Region 8 and TIPS Members reserves all rights and privileges under the applicable laws and regulations with respect to this procurement in the event of breach of contract by either party.
Does vendor agree?

Yes

60 2 CFR PART 200 Termination

Termination for cause and for convenience by the grantee or subgrantee including the manner by which it will be effected and the basis for settlement. (All contracts in excess of \$10,000)
Pursuant to the above, when federal funds are expended by ESC Region 8 and TIPS Members, ESC Region 8 and TIPS Members reserves the right to terminate any agreement in excess of \$10,000 resulting from this procurement process for cause after giving the vendor an appropriate opportunity and up to 30 days, to cure the causal breach of terms and conditions. ESC Region 8 and TIPS Members reserves the right to terminate any agreement in excess of \$10,000 resulting from this procurement process for convenience with 30 days notice in writing to the awarded vendor. The vendor would be compensated for work performed and goods procured as of the termination date if for convenience of the ESC Region 8 and TIPS Members. Any award under this procurement process is not exclusive and the ESC Region 8 and TIPS reserves the right to purchase goods and services from other vendors when it is in the best interest of the ESC Region 8 and TIPS.
Does vendor agree?

Yes

61	2 CFR PART 200 Clean Air Act	<p>Clean Air Act (42 U.S.C. 7401-7671q.) and the Federal Water Pollution Control Act (33 U.S.C. 1251-1387), as amended—Contracts and subgrants of amounts in excess of \$150,000 must contain a provision that requires the non-Federal award to agree to comply with all applicable standards, orders or regulations issued pursuant to the Clean Air Act (42 U.S.C. 7401-7671q) and the Federal Water Pollution Control Act as amended (33 U.S.C. 1251-1387). Violations must be reported to the Federal awarding agency and the Regional Office of the Environmental Protection Agency (EPA).</p> <p>Pursuant to the Clean Air Act, et al above, when federal funds are expended by ESC Region 8 and TIPS Members, ESC Region 8 and TIPS Members requires that the proposer certify that during the term of an award by the ESC Region 8 and TIPS Members resulting from this procurement process the vendor agrees to comply with all of the above regulations, including all of the terms listed and referenced therein.</p> <p>Does vendor agree?</p>	Yes
62	2 CFR PART 200 Byrd Anti-Lobbying Amendment	<p>Byrd Anti-Lobbying Amendment (31 U.S.C. 1352)—Contractors that apply or bid for an award exceeding \$100,000 must file the required certification. Each tier certifies to the tier above that it will not and has not used Federal appropriated funds to pay any person or organization for influencing or attempting to influence an officer or employee of any agency, a member of Congress, officer or employee of Congress, or an employee of a member of Congress in connection with obtaining any Federal contract, grant or any other award covered by 31 U.S.C. 1352. Each tier must also disclose any lobbying with non-Federal funds that takes place in connection with obtaining any Federal award. Such disclosures are forwarded from tier to tier up to the non-Federal award.</p> <p>Pursuant to the above, when federal funds are expended by ESC Region 8 and TIPS Members, ESC Region 8 and TIPS Members requires the proposer certify that during the term and during the life of any contract with ESC Region 8 and TIPS Members resulting from this procurement process the vendor certifies to the terms included or referenced herein.</p> <p>Does vendor agree?</p>	Yes
63	2 CFR PART 200 Federal Rule	<p>Compliance with all applicable standards, orders, or requirements issued under section 306 of the Clean Air Act (42 U.S.C. 1857(h)), section 508 of the Clean Water Act (33 U.S.C. 1368), Executive Order 11738, and Environmental Protection Agency regulations (40 CFR part 15). (Contracts, subcontracts, and subgrants of amounts in excess of \$100,000)</p> <p>Pursuant to the above, when federal funds are expended by ESC Region 8 and TIPS Members, ESC Region 8 and TIPS Members requires the proposer certify that in performance of the contracts, subcontracts, and subgrants of amounts in excess of \$100,000, the vendor will be in compliance with all applicable standards, orders, or requirements issued under section 306 of the Clean Air Act (42 U.S.C. 1857(h)), section 508 of the Clean Water Act (33 U.S.C. 1368), Executive Order 11738, and Environmental Protection Agency regulations (40 CFR part 15).</p> <p>Does vendor certify that it is in compliance with the Clean Air Act?</p>	Yes

64	2 CFR PART 200 Procurement of Recovered Materials	<p>A non-Federal entity that is a state agency or agency of a political subdivision of a state and its contractors must comply with section 6002 of the Solid Waste Disposal Act, as amended by the Resource Conservation and Recovery Act. The requirements of Section 6002 include procuring only items designated in guidelines of the Environmental Protection Agency (EPA) at 40 CFR part 247 that contain the highest percentage of recovered materials practicable, consistent with maintaining a satisfactory level of competition, where the purchase price of the item exceeds \$10,000 or the value of the quantity acquired during the preceding fiscal year exceeded \$10,000; procuring solid waste management services in a manner that maximizes energy and resource recovery; and establishing an affirmative procurement program for procurement of recovered materials identified in the EPA guidelines.</p> <p>Does vendor certify that it is in compliance with the Solid Waste Disposal Act as described above?</p>	Yes
65	Indemnification	<p>The ESC Region 8 and TIPS is a Texas Political Subdivision and a local governmental entity; therefore, is prohibited from indemnifying third parties pursuant to the Texas Constitution (Article 3, Section 52) except as specifically provided by law or as ordered by a court of competent jurisdiction. A provision in a contract to indemnify or hold a party harmless is a promise to pay for any expenses the indemnified party incurs, if a specified event occurs, such as breaching the terms of the contract or negligently performing duties under the contract. Article III, Section 49 of the Texas Constitution states that "no debt shall be created by or on behalf of the State ... " The Attorney General has counseled that a contractually imposed obligation of indemnity creates a "debt" in the constitutional sense. Tex. Att'y Gen. Op. No. MW-475 (1982). Contract clauses which require the System or institutions to indemnify must be deleted or qualified with "to the extent permitted by the Constitution and Laws of the State of Texas." Liquidated damages, attorney's fees, waiver of vendor's liability, and waiver of statutes of limitations clauses should also be deleted or qualified with "to the extent permitted by the Constitution and laws of State of Texas."</p> <p>Not a negotiable term. Failure to agree will render your proposal non-responsive and it will not be considered. Do you agree to these terms?</p>	Yes

66 Remedies	<p>The parties shall be entitled to exercise any right or remedy available to it either at law or in equity, subject to the choice of law, venue and service of process clauses limitations agreed herein. Nothing in this agreement shall commit the TIPS to an arbitration resolution of any disagreement under any circumstances. Any Claim arising out of or related to the Contract, except for those specifically waived under the terms of the Contract, may, after denial of the Board of Directors, be subject to mediation at the request of either party. Any issues not resolved hereunder must be referred to non-binding mediation to be conducted by a mutually agreed upon mediator as a prerequisite to the filing of any lawsuit over such issue(s). The parties shall share the mediator's fee and any associated filing fee equally. Mediation shall be held in Camp or Titus County, Texas. Agreements reached in mediation shall be reduced to writing, and will be subject to the approval by the District's Board of Directors, signed by the Parties if approved by the Board of Directors, and, if signed, shall thereafter be enforceable as provided by the laws of the State of Texas.</p> <p>Do you agree to these terms?</p>	Yes, I Agree
-------------	---	--------------

67 Remedies Explanation of No Answer

68 Choice of Law	<p>This agreement and any addenda or other additions and all contracts or awards resulting from this procurement process, however described, shall be governed by, construed and enforced in accordance with the laws of the State of Texas, regardless of any conflict of laws principles.</p> <p>Not a negotiable term. Failure to agree will render your proposal non-responsive and it will not be considered. Do you agree to these terms?</p>	Yes
------------------	---	-----

69 Jurisdiction and Service of Process	<p>Any Proceeding arising out of or relating to this procurement process or any contract issued by TIPS resulting from or any contemplated transaction shall be brought in a court of competent jurisdiction in Camp County, Texas and each of the parties irrevocably submits to the exclusive jurisdiction of said court in any such proceeding, waives any objection it may now or hereafter have to venue or to convenience of forum, agrees that all claims in respect of the Proceeding shall be heard and determined only in any such court, and agrees not to bring any proceeding arising out of or relating to this procurement process or any contract resulting from or any contemplated transaction in any other court. The parties agree that either or both of them may file a copy of this paragraph with any court as written evidence of the knowing, voluntary and freely bargained for agreement between the parties irrevocably to waive any objections to venue or to convenience of forum. Process in any Proceeding referred to in the first sentence of this Section may be served on any party anywhere in the world. Venue clauses in contracts with TIPS members may be determined by the parties.</p>	Yes
--	--	-----

Not a negotiable term. Failure to agree will render your proposal non-responsive and it will not be considered. Do you agree to these terms?

- 70 Alternative Dispute Resolution Yes, I Agree
Prior to filing of litigation, the parties may select non-binding mediation as a method of conflict resolution for issues arising out of or relating to this procurement process or any contract resulting from or any contemplated transaction. The parties agree that if nonbinding mediation is chosen as a resolution process, the parties must agree to the chosen mediator(s) and that all mediation venue shall be at a location in Camp or Titus, County, Texas agreed by the parties. The parties agree to share equally the cost of the mediation process and venue cost.
Do you agree to these terms?
- 71 Alternative Dispute Resolution Explanation of No Answer
- 72 Infringement(s) Yes, I Agree
The successful vendor will be expected to indemnify and hold harmless the TIPS and its employees, officers, agents, representatives, contractors, assignees and designees from any and all third party claims and judgments involving infringement of patent, copyright, trade secrets, trade or service marks, and any other intellectual or intangible property rights attributed to or claims based on the Vendor's proposal or Vendor's performance of contracts awarded and approved.
Do you agree to these terms?
- 73 Infringement(s) Explanation of No Answer
- 74 Acts or Omissions Yes, I Agree
The successful vendor will be expected to indemnify and hold harmless the TIPS, its officers, employees, agents, representatives, contractors, assignees and designees from and against any and all liability, actions, claims, demands or suits, and all related costs, attorney's fees and expenses arising out of, or resulting from any acts or omissions of the vendor or its agents, employees, subcontractors, or suppliers in the execution or performance of any agreements ultimately made by TIPS and the vendor.
Do you agree to these terms?
- 75 Acts or Omissions Explanation of No Answer
- 76 Contract Governance Yes
Any contract made or entered into by the TIPS is subject to and is to be governed by Section 271.151 et seq, Tex Loc Gov't Code. Otherwise, TIPS does not waive its governmental immunities from suit or liability except to the extent expressly waived by other applicable laws in clear and unambiguous language.

77 Payment Terms and Funding Out Clause

Payment Terms:
TIPS or TIPS members shall not be liable for interest or late payment fees on past due balances at a rate higher than permitted by the laws or regulations of the jurisdiction of the TIPS Member.

Yes

Funding Out Clause:
Vendor agrees to abide by the laws and regulations, including Texas Local Government Code § 271.903, or any statutory or regulatory limitations of the jurisdiction of any TIPS Member which governs contracts entered into by the Vendor and TIPS or a TIPS Member that requires all contracts approved by TIPS or a TIPS Member are subject to the budgeting and appropriation of currently available funds by the entity or its governing body.
See statute(s) for specifics or consult your legal counsel. Not a negotiable term. Failure to agree will render your proposal non-responsive and it will not be considered.
Do you agree to these terms?

78 Insurance and Fingerprint Requirements Information

Insurance
If applicable and your staff will be on TIPS member premises for delivery, training or installation etc. and/or with an automobile, you must carry automobile insurance as required by law. You may be asked to provide proof of insurance.

Fingerprint
It is possible that a vendor may be subject to Chapter 22 of the Texas Education Code. The Texas Education Code, Chapter 22, Section 22.0834. Statutory language may be found at: <http://www.statutes.legis.state.tx.us/>
If the vendor has staff that meet both of these criterion:
(1) will have continuing duties related to the contracted services; and
(2) has or will have direct contact with students
Then you have "covered" employees for purposes of completing the attached form.
TIPS recommends all vendors consult their legal counsel for guidance in compliance with this law. If you have questions on how to comply, see below. If you have questions on compliance with this code section, contact the Texas Department of Public Safety Non-Criminal Justice Unit, Access and Dissemination Bureau, FAST-FACT at NCJU@txdps.state.tx.us and you should send an email identifying you as a contractor to a Texas Independent School District or ESC Region 8 and TIPS. Texas DPS phone number is (512) 424-2474.
See form in the next attribute to complete entitled: Texas Education Code Chapter 22 Contractor Certification for Contractor Employees

(No Response Required)

79	Texas Education Code Chapter 22 Contractor Certification for Contractor Employees	<p>Introduction: Texas Education Code Chapter 22 requires entities that contract with school districts to provide services to obtain criminal history record information regarding covered employees. Contractors must certify to the district that they have complied. Covered employees with disqualifying criminal histories are prohibited from serving at a school district.</p> <p>Definitions: Covered employees: Employees of a contractor or subcontractor who have or will have continuing duties related to the service to be performed at the District and have or will have direct contact with students. The District will be the final arbiter of what constitutes direct contact with students. Disqualifying criminal history: Any conviction or other criminal history information designated by the District, or one of the following offenses, if at the time of the offense, the victim was under 18 or enrolled in a public school:</p> <p>(a) a felony offense under Title 5, Texas Penal Code; (b) an offense for which a defendant is required to register as a sex offender under Chapter 62, Texas Code of Criminal Procedure; or (c) an equivalent offense under federal law or the laws of another state.</p> <p>I certify that:</p> <p>NONE (Section A) of the employees of Contractor and any subcontractors are covered employees, as defined above. If this box is checked, I further certify that Contractor has taken precautions or imposed conditions to ensure that the employees of Contractor and any subcontractor will not become covered employees. Contractor will maintain these precautions or conditions throughout the time the contracted services are provided.</p> <p>OR</p> <p>SOME (Section B) or all of the employees of Contractor and any subcontractor are covered employees. If this box is checked, I further certify that:</p> <p>(1) Contractor has obtained all required criminal history record information regarding its covered employees. None of the covered employees has a disqualifying criminal history.</p> <p>(2) If Contractor receives information that a covered employee subsequently has a reported criminal history, Contractor will immediately remove the covered employee from contract duties and notify the District in writing within 3 business days.</p> <p>(3) Upon request, Contractor will provide the District with the name and any other requested information of covered employees so that the District may obtain criminal history record information on the covered employees.</p> <p>(4) If the District objects to the assignment of a covered employee on the basis of the covered employee's criminal history record information, Contractor agrees to discontinue using that covered employee to provide services at the District.</p> <p>Noncompliance or misrepresentation regarding this certification may be grounds for contract termination.</p>	None
80	Solicitation Deviation/Compliance	Does the vendor agree with the General Conditions Standard Terms and Conditions or Item Specifications listed in this proposal invitation?	Yes

81 Solicitation Exceptions/Deviations Explanation	<p>If the bidder intends to deviate from the General Conditions Standard Terms and Conditions or Item Specifications listed in this proposal invitation, all such deviations must be listed on this attribute, with complete and detailed conditions and information included or attached.</p> <p>TIPS will consider any deviations in its proposal award decisions, and TIPS reserves the right to accept or reject any bid based upon any deviations indicated below or in any attachments or inclusions.</p> <p>In the absence of any deviation entry on this attribute, the proposer assures TIPS of their full compliance with the Standard Terms and Conditions, Item Specifications, and all other information contained in this Solicitation.</p>	
82 Agreement Deviation/Compliance	Does the vendor agree with the language in the Vendor Agreement?	Yes
83 Agreement Exceptions/Deviations Explanation	<p>If the proposing Vendor desires to deviate from the Vendor Agreement language, all such deviations must be listed on this attribute, with complete and detailed conditions and information included. TIPS will consider any deviations in its proposal award decisions, and TIPS reserves the right to accept or reject any proposal based upon any deviations indicated below. In the absence of any deviation entry on this attribute, the proposer assures TIPS of their full compliance with the Vendor Agreement.</p>	
84 Texas Business and Commerce Code § 272 Requirements as of 9-1-2017	<p>SB 807 prohibits construction contracts to have provisions requiring the contract to be subject to the laws of another state, to be required to litigate the contract in another state, or to require arbitration in another state. A contract with such provisions is voidable. Under this new statute, a "construction contract" includes contracts, subcontracts, or agreements with (among others) architects, engineers, contractors, construction managers, equipment lessors, or materials suppliers. "Construction contracts" are for the design, construction, alteration, renovation, remodeling, or repair of any building or improvement to real property, or for furnishing materials or equipment for the project. The term also includes moving, demolition, or excavation. BY RESPONDING TO THIS SOLICITATION, PROPOSER AGREES TO COMPLY WITH THE TEXAS BUSINESS AND COMMERCE CODE § 272 WHEN EXECUTING CONTRACTS WITH TIPS MEMBERS THAT ARE TEXAS GOVERNMENT ENTITIES.</p>	(No Response Required)

Line Items

Response Total: \$0.00

Certification Regarding Lobbying

Applicable to Grants, Subgrants, Cooperative Agreements, and Contracts Exceeding \$100,000 in Federal Funds.

Submission of this certification is a prerequisite for making or entering into this transaction and is imposed by section 1352, Title 31, U.S. Code. This certification is a material representation of fact upon which reliance was placed when this transaction was made or entered into. Any person who fails to file the required certification shall be subject to a civil penalty of not less than \$10,000 and not more than \$100,000 for each such failure.

The undersigned certifies, to the best of his or her knowledge and belief, that:

(1) No Federal appropriated funds have been paid or will be paid by or on behalf of the undersigned, to any person for influencing or attempting to influence an officer or employee of any agency, a Member of Congress, an officer or employee of congress, or an employee of a Member of Congress in connection with the awarding of a Federal contract, the making of a Federal grant, the making of a Federal loan, the entering into a cooperative agreement, and the extension, continuation, renewal, amendment, or modification of a Federal contract, grant, loan, or cooperative agreement.

(2) If any funds other than Federal appropriated funds have been paid or will be paid to any person for influencing or attempting to influence an officer or employee of any agency, a Member of Congress, an officer or employee of congress, or an employee of a Member of Congress in connection with this Federal grant or cooperative agreement, the undersigned shall complete and submit Standard Form-LLL, "disclosure Form to Report Lobbying," in accordance with its instructions.

(3) The undersigned shall require that the language of this certification be included in the award documents for all covered subawards exceeding \$100,000 in Federal funds at all appropriate tiers and that all subrecipients shall certify and disclose accordingly.

SOPA, Inc.

2323 Cantrell Rd. Little Rock, AR 72202

Name/Address of Organization

Scott Greene / Vice President

Name/Title of Submitting Official

Signature

September 13, 2017

Date

FELONY CONVICTION NOTICE

FOR RESPONSE TO TIPS SOLICITATION

Statutory citation covering notification of criminal history of contractor is found in the Texas Education Code #44.034. Following is an example of a felony conviction notice:

State of Texas Legislative Senate Bill No. 1, Section 44.034, Notification of Criminal History, Subsection (a), states "a person or business entity that enters into a contract with a school district must give advance notice to the district if the person or an owner or operator of the business entity has been convicted of a felony. The notice must include a general description of the conduct resulting in the conviction of a felony." Subsection (b) states "a school district may terminate a contract with a person or business entity if the district determines that the person or business entity failed to give notice as required by Subsection (a) or misrepresented the conduct resulting in the conviction. The district must compensate the person or business entity for services performed before the termination of the contract."

THIS NOTICE IS NOT REQUIRED OF A PUBLICLY-HELD CORPORATION

Complete only one of the three below: A or B or C.

I, the undersigned agent for the firm named below, certify that the information concerning notification of felony convictions has been reviewed by me and the following information furnished is true to the best of my knowledge.

Official: Scott Greene

Print Authorized Company Official's Name

A. My firm is a publicly held corporation; therefore, this reporting requirement is not applicable.

Signature of Authorized Company Official: _____

OR

B. My firm is not owned nor operated by anyone who has been convicted of a felony:

Signature of Authorized Company Official: S. Greene

OR

C. My firm is owned or operated by the following individual(s) who has/have been convicted of a felony:

Name of Felon(s): _____

Details of Conviction(s): _____

You may attach another sheet

Signature of Authorized Company Official: _____



CERTIFICATION BY CORPORATE OFFERER

IF OFFERER IS A CORPORATION,

THE FOLLOWING CERTIFICATE SHOULD BE EXECUTED AND INCLUDED AS PART OF PROPOSAL FORM/PROPOSAL FORM.

OFFERER: SOPA, Inc.
(Name of Corporation)

I, Scott Greene certify that I am the Secretary of the Corporation
(Name of Corporate Secretary)

named as OFFERER herein above; that

Scott Greene
(Name of person who completed proposal document)

who signed the foregoing proposal on behalf of the corporation offerer is the authorized person that is acting as

Vice President
(Title/Position of person signing proposal/offer document within the corporation)

of the said Corporation; that said proposal/offer was duly signed for and in behalf of said corporation by authority of its governing body, and is within the scope of its corporate powers.

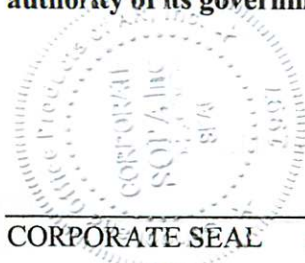
CORPORATE SEAL if available

SIGNATURE

September 13, 2017
DATE

2 CFR PART 200 Contract Provisions

**Required Federal contract provisions of Federal Regulations for Construction Contracts
for contracts with TIPS OR TIPS MEMBERS**

The following provisions are required to be in place and agreed if the procurement is funded in any part with federal funds.

The TIPS OR TIPS MEMBERS is the subgrantee or Subrecipient by definition. The Rules are located in 2 CFR PART 200 - Appendix II to Part 200—Contract Provisions for Non-Federal Entity Contracts Under Federal Awards at 2 CFR PART 200

In addition to other provisions required by the Federal agency or non-Federal entity, all contracts made by the non-Federal entity under the Federal award must contain provisions covering the following, as applicable.

(D) Davis-Bacon Act, as amended (40 U.S.C. 3141-3148). When required by Federal program legislation, all prime construction contracts in excess of \$2,000 awarded by non-Federal entities must include a provision for compliance with the Davis-Bacon Act (40 U.S.C. 3141-3144, and 3146-3148) as supplemented by Department of Labor regulations (29 CFR Part 5, "Labor Standards Provisions Applicable to Contracts Covering Federally Financed and Assisted Construction"). In accordance with the statute, contractors must be required to pay wages to laborers and mechanics at a rate not less than the prevailing wages specified in a wage determination made by the Secretary of Labor. In addition, contractors must be required to pay wages not less than once a week. The non-Federal entity must place a copy of the current prevailing wage determination issued by the Department of Labor in each solicitation. The decision to award a contract or subcontract must be conditioned upon the acceptance of the wage determination. The non-Federal entity must report all suspected or reported violations to the Federal awarding agency. The contracts must also include a provision for compliance with the Copeland "Anti-Kickback" Act (40 U.S.C. 3145), as supplemented by Department of Labor regulations (29 CFR Part 3, "Contractors and Subcontractors on Public Building or Public Work Financed in Whole or in Part by Loans or Grants from the United States"). The Act provides that each contractor or subrecipient must be prohibited from inducing, by any means, any person employed in the construction, completion, or repair of public work, to give up any part of the compensation to which he or she is otherwise entitled. The non-Federal entity must report all suspected or reported violations to the Federal awarding agency.

Pursuant to Federal Rule (D) above, when federal funds are expended by TIPS OR TIPS MEMBERS, during the term of an award for all contracts and subgrants for construction or repair, when Federal Funds are expended, by the TIPS OR TIPS MEMBERS resulting for this procurement process the vendor will be in compliance with all provisions listed or referenced therein.

Does vendor agree? YES _____ Initial of Authorized Company Official

(E) Contract Work Hours and Safety Standards Act (40 U.S.C. 3701-3708). Where applicable, all contracts awarded by the non-Federal entity in excess of \$100,000 that involve the employment of mechanics or laborers must include a provision for compliance with 40 U.S.C. 3702 and 3704, as supplemented by Department of Labor regulations (29 CFR Part 5). Under 40 U.S.C. 3702 of the Act, each contractor must be

2 CFR PART 200 Contract Provisions

required to compute the wages of every mechanic and laborer on the basis of a standard work week of 40 hours. Work in excess of the standard work week is permissible provided that the worker is compensated at a rate of not less than one and a half times the basic rate of pay for all hours worked in excess of 40 hours in the work week. The requirements of 40 U.S.C. 3704 are applicable to construction work and provide that no laborer or mechanic must be required to work in surroundings or under working conditions which are unsanitary, hazardous or dangerous. These requirements do not apply to the purchases of supplies or materials or articles ordinarily available on the open market, or contracts for transportation or transmission of intelligence.

Pursuant to Federal Rule above, when federal funds are expended by TIPS or TIPS Members, the proposer certifies that during the term of an award by the TIPS OR TIPS MEMBERS resulting from this procurement process for construction contracts awarded by grantees and subgrantees the proposer agrees to be in compliance with all requirements listed or referenced therein.

Does vendor agree? YES Initial of Authorized Company Official

Company Name SOPA, Inc.

Print name of authorized representative Scott Greene

Signature of authorized representative 

Date September 13, 2017

Federal Requirements for Procurement and Contracting with small and minority businesses, women's business enterprises, and labor surplus area firms.

The Education Service Center Region 8 and TIPS Members anticipate possibly using federal funds for procurement under this potential award and is required to obtain the following compliance assurance.

1. Will you be subcontracting any of your work under this award if you are successful? (Circle one)

YES or **NO**

2. If yes, do you agree to comply with the following federal requirements? (Circle one)

YES or **NO**

2 CFR §200.321 Contracting with small and minority businesses, women's business enterprises, and labor surplus area firms.

(a) The non-Federal entity must take all necessary affirmative steps to assure that minority businesses, women's business enterprises, and labor surplus area firms are used when possible.

(b) Affirmative steps must include:

- (1) Placing qualified small and minority businesses and women's business enterprises on solicitation lists;
- (2) Assuring that small and minority businesses, and women's business enterprises are solicited whenever they are potential sources;
- (3) Dividing total requirements, when economically feasible, into smaller tasks or quantities to permit maximum participation by small and minority businesses, and women's business enterprises;
- (4) Establishing delivery schedules, where the requirement permits, which encourage participation by small and minority businesses, and women's business enterprises;
- (5) Using the services and assistance, as appropriate, of such organizations as the Small Business Administration and the Minority Business Development Agency of the Department of Commerce ; and
- (6) Requiring the prime contractor, if subcontracts are to be let, to take the affirmative steps listed in paragraphs (1) through (5) of this section.

Company Name SOPA, Inc.

Print name of authorized representative Scott Greene

Signature of authorized representative 

Date September 13, 2017

Texas Government Code 2270 Verification Form

Texas 2017 House Bill 89 has been signed into law by the governor and as of September 1, 2017 will become law codified as Texas Government Code § 2270 and 808 et seq.

The relevant section addressed by this form reads as follows:

Texas Government Code Sec. 2270.002. PROVISION REQUIRED IN CONTRACT. A governmental entity may not enter into a contract with a company for goods or services unless the contract contains a written verification from the company that it: (1) does not boycott Israel; and (2) will not boycott Israel during the term of the contract.

I, Scott Greene as an authorized representative of

SOPA, Inc., a contractor/vendor

Insert Name of Company

engaged by

ESC Region 8/The Interlocal Purchasing System (TIPS)
4845 Highway 271 North
Pittsburg, TX, 75686

verify by this writing that the above-named company affirms that it (1) does not boycott Israel; and (2) will not boycott Israel during the term of this contract, or any contract with the above-named Texas governmental entity in the future. I further affirm that if our company's position on this issue is reversed and this affirmation is no longer valid, that the above-named Texas governmental entity will be notified in writing within one (1) business day and we understand that our company's failure to affirm and comply with the requirements of Texas Government Code 2270 et seq. shall be grounds for immediate contract termination without penalty to the above-named Texas governmental entity.

I swear and affirm that the above is true and correct.

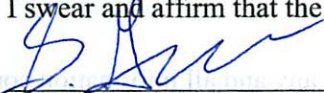

Signature of Named Authorized Company Representative

September 13, 2017

Date

504-663-8500

Phone

AR 75605

State ZIP

Little Rock

City

5078 Central Rd

Address

FAILURE TO PROPERLY COMPLETE THIS FORM AND SUBMIT WITH YOUR RESPONSE MAY RESULT IN A WAIVER OF YOUR RIGHTS UNDER THE LAW TO MAINTAIN CONFIDENTIALITY TREATMENT OF SUBMITTED MATERIALS.

CONFIDENTIAL INFORMATION SUBMITTED IN RESPONSE TO COMPETITIVE PROCUREMENT REQUESTS OF EDUCATION SERVICE CENTER REGION 8 AND TIPS IS GOVERNED BY TEXAS GOVERNMENT CODE, CHAPTER 552

If you consider any portion of your proposal to be confidential information and not subject to public disclosure pursuant to Chapter 552 Tex Gov't Code or other law(s), **you must make a copy of all claimed confidential materials within your proposal and put this COMPLETED form as a cover sheet to said materials then scan, name "CONFIDENTIAL" and upload with your proposal submission.** (You must include the confidential information in the submitted proposal as well, the copy uploaded is to indicate which material in your proposal, if any, you deem confidential in the event the District receives a Public Information Request.) Education Service Center Region 8 and TIPS will follow procedures of controlling statute(s) regarding any claim of confidentiality and shall not be liable for any release of information required by law. Pricing of solicited product or service may be deemed as public information under Chapter 552 Tex Gov't Code. The Office of Texas Attorney General shall make the final determination whether the information held by Education Service Center Region 8 and TIPS is confidential and exempt from public disclosure.

I DO NOT desire to expressly waive any claim of confidentiality as to any and all information contained within our response to the competitive procurement process (e.g. RFP, CSP, Bid, RFQ, etc.) by completing the following and submitting this sheet with our response to Education Service Center Region 8 and TIPS. The attached contains material from our proposal that I classify and deem confidential under Texas Gov't Code Sec. 552 or other law(s) and I invoke my statutory rights to confidential treatment of the enclosed materials:

Name of company claiming confidential status of material

Printed Name, Title, and Signature of authorized company officer claiming confidential status of material

Address City State ZIP Phone

ATTACHED ARE COPIES OF _____ PAGES OF CONFIDENTIAL MATERIAL FROM OUR PROPOSAL

Express Waiver: I desire to expressly waive any claim of confidentiality as to any and all information contained within our response to the competitive procurement process (e.g. RFP, CSP, Bid, RFQ, etc.) by completing the following and submitting this sheet with our response to Education Service Center Region 8 and TIPS.

SOPA, Inc.

Name of company expressly waiving confidential status of material

Scott Greene | Vice President | 

Printed Name, Title, and Signature of authorized company officer expressly waiving confidential status of material

2323 Cantrell Rd Little Rock AR 72202 501-663-5500
Address City State ZIP Phone

Limited Product Warranty

Interior Fixed & Portable Seating Collections

Hussey Seating Company provides the following warranty to the owner and operator of the facility in which Hussey Seating Products were purchased and installed in North America. The warranty period begins on the date of installation completion, continues for the applicable time period set forth below, and is strictly governed by and subject to the terms and conditions set forth below.

LIMITED WARRANTY:

In the event there is a defect in the material, in the installation (in the event installation is contracted through Hussey Seating), and/or in the workmanship of the Hussey Seating Product (or component thereof) which causes failure of the product within the applicable time period and provided notification of this defect is given to Hussey Seating in writing at the address set forth below prior to the expiration of the applicable time period; Hussey Seating, in its sole discretion, will either repair or replace the defective product (or defective component thereof) with a comparable product (or component thereof), or will provide a refund of the purchase price of the defective product (or defective component thereof) prorated over the warranty period. In the event of repair or replacement, the warranty includes labor, materials, and freight for the first five years of the warranty and materials and freight thereafter for products covered by the limited lifetime period. All other costs are excluded. The fulfillment of the warranty (including investigation, timing of response, labor, and manner of shipment) is under the exclusive and unfettered control of Hussey Seating.

TIME PERIODS:

12 Years	8 Years	5 Years	3 Years	1 Year
Structural Components Weather Fighter* Frames	Heavy Duty Titan Model Structural Components	Component parts of operating mechanisms, structural attachments, accessories, and assembly hardware. Tablet Arms & Mechanisms	Surface Material Finishes: Polymer & Powder Coat (Note conditions as to color, grain and texture listed below.) Surface Material Finishes: Wood Veneer & Plastic Laminates (Note conditions as to color, grain and texture listed below.)	Non-standard items: Upholstery, stitching, foam, power and data components

EXCLUSIONS AND CONDITIONS: This warranty excludes and does not apply to:

- Feet, Glides and Casters.
- Normal wear and tear, abuse, neglect, vandalism, alteration, or misuse – all determined by Hussey Seating in its sole discretion.
- Acts of God.
- Product altered or modified by the user.
- User attached accessories.
- Products not installed by Hussey Seating Approved Installers.
- Seating Upholstery materials will be provided with a pass through warranty as supported by the selected upholstery mill, fabric line and color SKU.
- Applied Graphic Solutions.
- Products not properly maintained in accordance with Hussey Seating Operating & Maintenance Procedures & Inspections.
- Customers Own and/or Specified Materials, leathers, and non-standard material and color finishes whether purchased by the customer or Hussey Seating Company.
- Natural variations occurring in wood and leather and/or color fastness and/or variations in matching of colors, grains or textures of materials shall not be considered defects.
- Polymer Colors will not fade greater than 5 Delta-E units measured within CIE L*a*b color space.
- Powder Coat finish will not fade greater than 5 Delta-E units measured by Hunter L*a*b Color difference per ASTM D2244.

**NOTE on Weather Fighter chairs: This is a weather resistant chair only – it is not warranted to be weather proof. Clarin by Hussey Seating does not recommend keeping or storing chairs outdoors where they are exposed directly to rain or other extreme weather conditions for an extended period of time (i.e. longer than one day) without being stored inside and dried completely. Clarin by Hussey Seating's warrant does not cover defects caused by direct exposure to rain or other extreme weather conditions for extended periods of time.*

In the event of repair or replacement of the defective product (or defective component thereof) there is no responsibility for the matching of color, grain, fabric, or texture except to within commercially acceptable standards, as determined by Hussey Seating in its sole discretion. **THERE ARE NO OTHER WARRANTIES OTHER THAN THOSE EXPRESSLY STATED ABOVE, WHETHER EXPRESSED OR IMPLIED (INCLUDING, BUT NOT LIMITED TO, ANY WARRANTY OR MERCHANTABILITY OR FITNESS FOR ANY PARTICULAR PURPOSE) UNLESS SPECIFICALLY AGREED TO IN WRITING BY AN OFFICER OF HUSSEY SEATING IN THE SPECIFIC CIRCUMSTANCE.** Hussey Seating is not liable (in contract, tort, or otherwise) for any consequential, special, direct, punitive, or incidental damage.

WARRANTY NOTICE ADDRESS: **Hussey Seating Company**
 Attn: Product Warranty
 38 Dyer Street Ext.,
 North Berwick, Maine 03906 USA

Product Line Warranty: Clarin by Hussey Seating™ Multi-Purpose Chairs and Tables: Equinox™, Lunar™, Latitude™, Cielo™, Solstice™, Ellipsis™, Meridian™, Infinity™, Compass™, Traditional Collection, Beam, Pedestal and Jury Base Seating and The Self-Returning Swivel Seat.
Clarin by Hussey Seating™ Portable Folding Chairs, Stools & Storage Carts.

Product Warrant

Exterior Fixed Seating Collections

Hussey Seating Company provides the following warranty to the owner and operator of the facility in which Hussey Seating Products were purchased and installed in North America. The warranty period begins on the date of installation completion, continues for the applicable time period set forth below, and is strictly governed by and subject to the terms and conditions set forth below.

WARRANTY:

In the event there is a defect in the material, in the installation (in the event installation is controlled by Hussey Seating), and/or in the workmanship of the Hussey Seating Product (or component there of) which causes failure of the product within the applicable time period and provided notification of this defect is given to Hussey Seating in writing at the address set forth below prior to the expiration of the applicable time period; Hussey Seating, in its sole discretion, will either repair or replace the defective product (or defective component there of) with a comparable product (or component there of), or will provide a refund of the purchase price of the defective product (or defective component there of) prorated over the warranty period. In the event of repair or replacement, the warranty includes labor, materials, and freight for the first five years of the warranty and materials and freight there after. All other costs are excluded. The fulfillment of the warranty (including investigation, timing of response, labor, and manner of shipment) is under the exclusive and unfettered control of Hussey Seating.

TIME PERIODS:

Limited Lifetime	5 Years	3 Years	1 Year
Structural Standards Cast Seat Supports & Brackets Dual Action Seat Return Springs	Component parts of operating mechanisms and structural attachments including related assembly hardware. Self Rising Seat Mechanism Cracking and or Crazing of Polymer Components (Seats and Backs)	Foam Components; Seats & Back Surface Material Finishes: Powder Coat (Note conditions as to color, grain and texture listed below.)	Upholstery Stitching Process & Thread Wear Uniroyal Surfside Naugahyde Surface Material Finishes: Polymer (Note conditions as to color, grain and texture listed below.)

EXCLUSIONS AND CONDITIONS: This warranty excludes and does not apply to:

- Conditions other than normal wear and tear, of abuse, of neglect, of vandalism, or of misuse – all determined by Hussey Seating in its sole discretion.
 - Acts of God.
 - Product altered or modified by the user.
 - User attached accessories.
 - Consumable Products; light bulbs, lamps, ballasts.
 - Products not installed by Hussey Seating Approved Installers.
 - Seating Upholstery materials will be provided with a pass through warranty as supported by the selected upholstery, fabric line and color SKU.
 - Applied Graphic Solutions.
 - Products not properly maintained in accordance with Hussey Seating Operating & Maintenance Procedures & Inspections.
 - Customers Own and / or Specified Materials, leathers, and non standard material and color finishes whether purchased by the customer or Hussey Seating Company.
 - Natural variations occurring in wood and leather and / or color fastness and / or variations in matching of colors, grains or textures of materials shall not be considered defects.
 - Polymer Colors will not fade greater than 5 Delta-E units measured within CIE L*a*b color space.
 - Powder Coat finish will not fade greater than 5 Delta-E units measured by Hunter L*a*b Color difference per ASTM D2244.
- NOTE: High Chromatic colors are warranted for one year. A longer warranty period is available at an additional price.

In the event of repair or replacement of the defective product (or defective component there of) there is no responsibility for the matching of color, grain, fabric, or texture except to within commercially acceptable standards, as determined by Hussey Seating in its sole discretion. **THERE ARE NO OTHER WARRANTIES OTHER THAN THOSE EXPRESSLY STATED ABOVE, WHETHER EXPRESSED OR IMPLIED (INCLUDING, BUT NOT LIMITED TO, ANY WARRANTY OR MERCHANTABILITY OR FITNESS FOR ANY PARTICULAR PURPOSE) UNLESS SPECIFICALLY AGREED TO IN WRITING BY AN OFFICER OF HUSSEY SEATING IN THE SPECIFIC CIRCUMSTANCE** Hussey Seating is not liable for consequential or incidental damage arising from any product defect.

WARRANTY NOTICE ADDRESS:

Hussey Seating Company
Attn: Customer Services & Product Warranty Team
38 Dyer Street Ext.
North Berwick, Maine 03906 USA

Product Line Warranty: Quattro Extreme, Sports & Entertainment Seating Collection

Product Warranty

Exterior Fixed Seating Collections

Hussey Seating Company provides the following warranty to the owner and operator of the facility in which Hussey Seating Products were purchased and installed in North America. The warranty period begins on the date of installation completion, continues for the applicable time period set forth below, and is strictly governed by and subject to the terms and conditions set forth below.

WARRANTY:

In the event there is a defect in the material, in the installation (in the event installation is controlled by Hussey Seating), and/or in the workmanship of the Hussey Seating Product (or component there of) which causes failure of the product within the applicable time period and provided notification of this defect is given to Hussey Seating in writing at the address set forth below prior to the expiration of the applicable time period; Hussey Seating, in its sole discretion, will either repair or replace the defective product (or defective component there of) with a comparable product (or component there of), or will provide a refund of the purchase price of the defective product (or defective component there of) prorated over the warranty period. In the event of repair or replacement, the warranty includes labor, materials, and freight for the first five years of the warranty and materials and freight there after. All other costs are excluded. The fulfillment of the warranty (including investigation, timing of response, labor, and manner of shipment) is under the exclusive and unfettered control of Hussey Seating.

TIME PERIODS:

Limited Lifetime	5 Years	3 Years	1 Year
Structural Standards Cast Seat Supports & Brackets Dual Action Seat Return Springs	Component parts of operating mechanisms and structural attachments including related assembly hardware. Self Rising Seat Mechanism Cracking and or Crazing of Polymer Components (Seats and Backs)	Foam Components; Seats & Back Surface Material Finishes: Powder Coat (Note conditions as to color, grain and texture listed below.)	Upholstery Stitching Process & Thread Wear Uniroyal Surfside Naugahyde Surface Material Finishes: Polymer (Note conditions as to color, grain and texture listed below.)

EXCLUSIONS AND CONDITIONS: This warranty excludes and does not apply to:

- Conditions other than normal wear and tear, of abuse, of neglect, of vandalism, or of misuse – all determined by Hussey Seating in its sole discretion.
 - Acts of God.
 - Product altered or modified by the user.
 - User attached accessories.
 - Consumable Products; light bulbs, lamps, ballasts.
 - Products not installed by Hussey Seating Approved Installers.
 - Seating Upholstery materials will be provided with a pass through warranty as supported by the selected upholstery, fabric line and color SKU.
 - Applied Graphic Solutions.
 - Products not properly maintained in accordance with Hussey Seating Operating & Maintenance Procedures & Inspections.
 - Customers Own and / or Specified Materials, leathers , and non standard material and color finishes whether purchased by the customer or Hussey Seating Company.
 - Natural variations occurring in wood and leather and / or color fastness and / or variations in matching of colors, grains or textures of materials shall not be considered defects.
 - Polymer Colors will not fade greater than 5 Delta-E units measured within CIE L*a*b color space.
 - Powder Coat finish will not fade greater than 5 Delta-E units measured by Hunter L*a*b Color difference per ASTM D2244.
- NOTE: High Chromatic colors are warranted for one year.
A longer warranty period is available at an additional price.

In the event of repair or replacement of the defective product (or defective component there of) there is no responsibility for the matching of color, grain, fabric, or texture except to within commercially acceptable standards, as determined by Hussey Seating in its sole discretion. THERE ARE NO OTHER WARRANTIES OTHER THAN THOSE EXPRESSLY STATED ABOVE, WHETHER EXPRESSED OR IMPLIED (INCLUDING, BUT NOT LIMITED TO, ANY WARRANTY OR MERCHANTABILITY OR FITNESS FOR ANY PARTICULAR PURPOSE) UNLESS SPECIFICALLY AGREED TO IN WRITING BY AN OFFICER OF HUSSEY SEATING IN THE SPECIFIC CIRCUMSTANCE Hussey Seating is not liable for consequential or incidental damage arising from any product defect.

WARRANTY NOTICE ADDRESS:

Hussey Seating Company
Attn: Customer Services & Product Warranty Team
38 Dyer Street Ext.
North Berwick, Maine 03906 USA

Product Warranty

Interior Fixed & Portable Seating Collections

Hussey Seating Company provides the following warranty to the owner and operator of the facility in which Hussey Seating Products were purchased and installed in North America. The warranty period begins on the date of installation completion, continues for the applicable time period set forth below, and is strictly governed by and subject to the terms and conditions set forth below.

WARRANTY:

In the event there is a defect in the material, in the installation (in the event installation is controlled by Hussey Seating), and/or in the workmanship of the Hussey Seating Product (or component there of) which causes failure of the product within the applicable time period and provided notification of this defect is given to Hussey Seating in writing at the address set forth below prior to the expiration of the applicable time period; Hussey Seating, in its sole discretion, will either repair or replace the defective product (or defective component there of) with a comparable product (or component there of), or will provide a refund of the purchase price of the defective product (or defective component there of) prorated over the warranty period. In the event of repair or replacement, the warranty includes labor, materials, and freight for the first five years of the warranty and materials and freight there after. All other costs are excluded. The fulfillment of the warranty (including investigation, timing of response, labor, and manner of shipment) is under the exclusive and unfettered control of Hussey Seating.

TIME PERIODS:

Limited Lifetime	5 Years
Structural Standards	Component parts of operating mechanisms and structural attachments including related assembly hardware.
Cast Seat Supports & Brackets	Self Rising Seat Mechanism
Dual Action Seat Return Springs	Tablet Arms & Mechanisms
	Electrical: Aisle Lights, Power and Data Quick-Link System
	Upholstery Stitching Process & Thread Wear
	Foam Components; Seats, Back and Armrest
	Surface Material Finishes: Polymer & Powder Coat (Note conditions as to color, grain and texture listed below.)
	Surface Material Finishes: Wood Veneer & Plastic Laminates (Note conditions as to color, grain and texture listed below.)

EXCLUSIONS AND CONDITIONS: This warranty excludes and does not apply to:

- Conditions other than normal wear and tear, of abuse, of neglect, of vandalism, or of misuse – all determined by Hussey Seating in its sole discretion.
- Acts of God.
- Product altered or modified by the user.
- User attached accessories.
- Consumable Products; light bulbs, lamps, ballasts.
- Products not installed by Hussey Seating Approved Installers.
- Seating Upholstery materials will be provided with a pass through warranty as supported by the selected upholstery mill, fabric line and color SKU.
- Applied Graphic Solutions.
- Products not properly maintained in accordance with Hussey Seating Operating & Maintenance Procedures & Inspections.
- Customers Own and / or Specified Materials, leathers , and non standard material and color finishes whether purchased by the customer or Hussey Seating Company.
- Natural variations occurring in wood and leather and / or color fastness and / or variations in matching of colors, grains or textures of materials shall not be considered defects.
- Polymer Colors will not fade greater than 5 Delta-E units measured within CIE L*a*b color space.
- Powder Coat finish will not fade greater than 5 Delta-E units measured by Hunter L*a*b Color difference per ASTM D2244.

In the event of repair or replacement of the defective product (or defective component there of) there is no responsibility for the matching of color, grain, fabric, or texture except to within commercially acceptable standards, as determined by Hussey Seating in its sole discretion. **THERE ARE NO OTHER WARRANTIES OTHER THAN THOSE EXPRESSLY STATED ABOVE, WHETHER EXPRESSED OR IMPLIED (INCLUDING, BUT NOT LIMITED TO, ANY WARRANTY OR MERCHANTABILITY OR FITNESS FOR ANY PARTICULAR PURPOSE) UNLESS SPECIFICALLY AGREED TO IN WRITING BY AN OFFICER OF HUSSEY SEATING IN THE SPECIFIC CIRCUMSTANCE.** Hussey Seating is not liable for consequential or incidental damage arising from any product defect.

WARRANTY NOTICE ADDRESS:

Hussey Seating Company
Attn: Customer Services & Product Warranty Team
38 Dyer Street Ext.
North Berwick, Maine 03906 USA

Product Line Warranty: Quattro Seating Collection, Metro Seating Collection, Gallery 3 Seating Collection and Sports & Entertainment Seating Collection

Product Warranty

PERMA-CAP®

Hussey Seating Company provides the following warranty to the owner and operator of the facility in which Hussey Seating Products were purchased and installed in North America. The warranty period begins on the "date of purchase" shall be the date that the product is shipped from Hussey Seating Company. This warranty shall be void if the product has not been paid for in full.

WARRANTY:

Hussey Seating Company (Hussey Seating Company) warrants to the original owner for the period of five years from the date of purchase Hussey Seating Company Perma-Cap® bleacher covering system, subject to the limitations and conditions listed below, to be free of defects in materials or workmanship that, in the course of normal and proper use, result flaking, peeling, corroding, blistering or abnormal discoloration.

Hussey Seating Company will, at its option, repair, replace (excluding the cost of shipping or labor charges or other expenses of any kind associated with the installation or removal of the original or replacement product) the bleacher covering system component(s) found defective by Hussey Seating Company as follows: 100% in year 1, 70% in year 2, 40% in year 3 and 10% in year 4 and 5. Hussey Seating Company shall not have any warranty obligations after the end of the 5th year from the date of purchase.

For the purposes of this warranty, "date of purchase" shall be the date that the product is shipped from Hussey Seating Company. This warranty shall be void if the product has not been paid for in full.

TIME PERIOD:

5 Years
PERMA-CAP, End Caps & Splice Plates

EXCLUSIONS AND CONDITIONS: This warranty does not provide protection against any failure, defect or damage caused by situations, conditions or events beyond the control of Hussey Seating Company, including, but not limited to:

- Misuse, abuse, neglect or improper handling or storage.
- Movement, distortion, collapse or settling of the ground or structure on which the Hussey Seating Company product is installed.
- Improper installation or installation not in strict adherence to Hussey Seating Company's written instructions.
- Negligence in or failure to provide reasonable and necessary maintenance to prevent an accumulation of surface dirt, chalk, staining or mildew, or damage resulting from the use of harmful cleaning compounds. (Please see care and maintenance instructions).
- Use of accessories that do not properly receive and/or secure Hussey Seating Company's products.
- Use of or connection with any non-Hussey Seating Company products.
- Impact of foreign objects, fire, earthquake, lightening, hail, hurricane, tornado or other casualty or act of God.
- Applied Graphic Solutions.

In no event shall Hussey Seating Company's responsibility under this warranty exceed the amount of the product's original purchase price.

This warranty shall only extend to product in the stocking colors listed on our color chart. This warranty shall not apply to the color Black when used outdoors, or any special order colors unless Hussey Seating Company agrees in writing. The color of replacement product may be different from the color of remaining installed Hussey Seating Company product. This warranty does not cover, nor is Hussey Seating Company responsible for color differences between replacement product and remaining installed product.

Hussey Seating Company reserves the right to discontinue, modify or make changes in its products. If products covered by this warranty are not available, Hussey Seating Company has the option to substitute products of equal quality and value. Exposure to sunlight and the extremes of weather and temperature (normal weathering) will cause any colored surface to gradually fade, change color, darken, or chalk. The degree to which this occurs may be affected by air quality, the geographic location of the property or other local conditions over which Hussey Seating Company has no control. Fading and color change of the product due to normal weathering are to be expected and does not constitute "abnormal discoloration". Hussey Seating Company shall have the sole discretion to determine, based upon reasonable criteria, whether the product is suffering from abnormal discoloration.

CLAIM PROCEDURE

The original owner must give prompt notice of any defect to obtain service under this warranty. Notice of the defect must be mailed to Hussey Seating Company, 38 Dyer Street Ext., North Berwick, ME 03906. The remedies under this warranty, if applicable, shall be provided within a reasonable time after Hussey Seating Company's receipt of such notice. Proof of purchase showing the date of purchase such as sales receipt or other purchase document is required when requesting warranty service. Failure to provide satisfactory proof of purchase will void coverage under this warranty.



husseyseating

YOUR PARTNER FOR SEATING SOLUTIONS

OTHER CONDITIONS:

This limited warranty is in lieu of all other warranties, express or implied including, without limitation, any implied warranties of merchantability or fitness for a particular purpose. Any express or implied warranty not provided herein, and any remedy for breach of contract, tort or otherwise which, but for this provision, might arise by implication or operation of law, is hereby excluded and disclaimed. Hussey Seating Company shall not be liable for inconvenience, labor, loss of time, or other incidental, special or consequential damages or losses arising in relation to the purchase or use of Hussey Seating Company products and regardless of whether arising from breach of warranty, breach of contract, negligence or other tort, or otherwise. Any implied warranties of merchantability or fitness for a particular purpose deemed applicable by law to Hussey Seating Company products shall BE limited in duration to the original purchaser for a period of FIVE years. This warranty gives you specific legal rights, and you may also have other rights, which vary from state to state. Some states do not allow the exclusion or limitations of incidental or consequential damages, or how long an implied warranty lasts, so the above limitations may not apply to you.

This is a "limited warranty" within the meaning of the Magnuson-Moss Warranty-Federal Trade Commission Improvement Act. This warranty gives you specific legal rights and you may also have other rights, which may vary from state to state.

WARRANTY NOTICE ADDRESS:

Hussey Seating Company

Attn: Customer Services & Product Warranty Team
38 Dyer Street Ext.
North Berwick, Maine 03906 USA

Product Line Warranty: PERMA-CAP[®]

www.husseyseating.com | HSC Standard Product Warranty | PERMA-CAP | APR 2015

Product Warranty

PERMA-PLANK®

Hussey Seating Company provides the following warranty to the owner and operator of the facility in which Hussey Seating Products were purchased and installed in North America. The warranty period begins on the "date of purchase" shall be the date that the product is shipped from Hussey Seating Company. This warranty shall be void if the product has not been paid for in full.

WARRANTY:

Hussey Seating Company (Hussey Seating Company) warrants to the original owner for the period of five years from the date of purchase Hussey Seating Company Perma-Plank® roll form bleacher seating system, to include roll formed planks and mounting structures are subject to the limitations and conditions listed below, to be free of defects in materials or workmanship that, in the course of normal and proper use.

Hussey Seating Company will, at its option, repair, replace (excluding the cost of shipping or labor charges or other expenses of any kind associated with the installation or removal of the original or replacement product) Perma-Plank® roll form bleacher seating system system found defective by Hussey Seating Company. Hussey Seating Company shall not have any warranty obligations after the end of the 5th year from the date of purchase.

For the purposes of this warranty, "date of purchase" shall be the date that the product is shipped from Hussey Seating Company. This warranty shall be void if the product has not been paid for in full.

TIME PERIOD:

5 Years
PERMA-PLANK, Mounting Brackets [Deck, Floor and Riser Mount Attachments]

EXCLUSIONS AND CONDITIONS: This warranty does not provide protection against any failure, defect or damage caused by situations, conditions or events beyond the control of Hussey Seating Company, including, but not limited to:

- Misuse, abuse, neglect or improper handling or storage.
- Improper installation or installation not in strict adherence to Hussey Seating Company's written instructions.
- Use of accessories that do not properly receive and/or secure Hussey Seating Company's products.
- Impact of foreign objects, fire, earthquake, lightening, hail, hurricane, tornado or other casualty or act of God.
- Applied Graphic Solutions.
- Movement, distortion, collapse or settling of the ground or structure on which the Hussey Seating Company product is installed.
- Negligence in or failure to provide reasonable and necessary maintenance to prevent an accumulation of surface dirt, chalk, staining or mildew, or damage resulting from the use of harmful cleaning compounds. (Please see care and maintenance instructions).
- Use of or connection with any non-Hussey Seating Company products.

In no event shall Hussey Seating Company's responsibility under this warranty exceed the amount of the product's original purchase price.

Hussey Seating Company reserves the right to discontinue, modify or make changes in its products. If products covered by this warranty are not available, Hussey Seating Company has the option to substitute products of equal quality and value. Exposure to sunlight and the extremes of weather and temperature (normal weathering) will cause any colored surface to gradually fade, change color, darken, or chalk. The degree to which this occurs may be affected by air quality, the geographic location of the property or other local conditions over which Hussey Seating Company has no control. Fading and color change of the product due to normal weathering are to be expected and does not constitute "abnormal discoloration". Hussey Seating Company shall have the sole discretion to determine, based upon reasonable criteria, whether the product is suffering from abnormal discoloration.

CLAIM PROCEDURE

The original owner must give prompt notice of any defect to obtain service under this warranty. Notice of the defect must be mailed to Hussey Seating Company, 38 Dyer Street Ext., North Berwick, ME 03906. The remedies under this warranty, if applicable, shall be provided within a reasonable time after Hussey Seating Company's receipt of such notice. Proof of purchase showing the date of purchase such as sales receipt or other purchase document is required when requesting warranty service. Failure to provide satisfactory proof of purchase will void coverage under this warranty.



husseyseating

YOUR PARTNER FOR SEATING SOLUTIONS

OTHER CONDITIONS:

This limited warranty is in lieu of all other warranties, express or implied including, without limitation, any implied warranties of merchantability or fitness for a particular purpose. Any express or implied warranty not provided herein, and any remedy for breach of contract, tort or otherwise which, but for this provision, might arise by implication or operation of law, is hereby excluded and disclaimed. Hussey Seating Company shall not be liable for inconvenience, labor, loss of time, or other incidental, special or consequential damages or losses arising in relation to the purchase or use of Hussey Seating Company products and regardless of whether arising from breach of warranty, breach of contract, negligence or other tort, or otherwise. Any implied warranties of merchantability or fitness for a particular purpose deemed applicable by law to Hussey Seating Company products shall BE limited in duration to the original purchaser for a period of FIVE years. This warranty gives you specific legal rights, and you may also have other rights, which vary from state to state. Some states do not allow the exclusion or limitations of incidental or consequential damages, or how long an implied warranty lasts, so the above limitations may not apply to you.

This is a "limited warranty" within the meaning of the Magnuson-Moss Warranty-Federal Trade Commission Improvement Act. This warranty gives you specific legal rights and you may also have other rights, which may vary from state to state.

WARRANTY NOTICE ADDRESS:

Hussey Seating Company

Attn: Customer Services & Product Warranty Team
38 Dyer Street Ext.
North Berwick, Maine 03906 USA

Product Line Warranty: PERMA-PLANK®

www.husseyseating.com | HSC Standard Product Warranty | PERMA-PLANK | APR 2015

Limited Product Warranty

Telescopic Equipment

Hussey Seating Company provides the following warranty to the owner and operator of the facility in which Hussey Seating Products were purchased and installed in North America. The warranty period begins on the date of installation completion, continues for the applicable time period set forth below, and is strictly governed by and subject to the terms and conditions set forth below.

LIMITED WARRANTY:

In the event there is a defect in the material, in the installation (in the event installation is contracted through Hussey Seating), and/or in the workmanship of the Hussey Seating Product (or component thereof) which causes failure of the product within the applicable time period and provided notification of this defect is given to Hussey Seating in writing at the address set forth below prior to the expiration of the applicable time period; Hussey Seating, in its sole discretion, will either repair or replace the defective product (or defective component thereof) with a comparable product (or component thereof), or will provide a refund of the purchase price of the defective product (or defective component thereof) prorated over the warranty period. In the event of repair or replacement, the warranty includes labor, materials, and freight for five years. All other costs are excluded. The fulfillment of the warranty (including investigation, timing of response, labor, and manner of shipment) is under the exclusive and unfettered control of Hussey Seating.

TIME PERIOD:

<p>5 Years</p> <p>Component parts of Understructure operating mechanisms, structural attachments including safety rails, assembly hardware, & accessories. Decking Systems including aisle steps, CourtSide & Classic Wood Seating Collections</p> <p>Electrical: Aisle Lights & Power Systems</p> <p>Portable & Integral Dolly Systems</p> <p>End Closure Curtains</p> <p>Surface Material Finishes: Polymer & Powder Coat (Note conditions as to color, grain and texture listed below.)</p> <p>Surface Material Finishes: Wood Veneer (Note conditions as to color, grain and texture listed below.)</p>
--

EXCLUSIONS AND CONDITIONS: This warranty excludes and does not apply to:

- Normal wear and tear, abuse, neglect, vandalism, alteration, or misuse – all determined by Hussey Seating in its sole discretion.
- Acts of God.
- Product altered or modified by the user.
- User attached accessories.
- Consumable Products; light bulbs, lamps, ballasts.
- Products not installed by Hussey Seating Approved Installers.
- Applied Graphic Solutions.
- Products not properly maintained in accordance with Hussey Seating Operating & Maintenance Procedures & Inspection requirements.
- Natural variations occurring in wood and/or color fastness and/or variations in matching of colors, grains or textures of materials shall not be considered defects.
- Polymer Colors will not fade greater than 5 Delta-E units measured within CIE L*a*b color space.
- Powder Coat finish will not fade greater than 5 Delta-E units measured by Hunter L*a*b Color difference per ASTM D2244.
- Powder Coat finish will not fade greater than 5 Delta-E units measured by Hunter L*a*b Color difference per ASTM D2244.

In the event of repair or replacement of the defective product (or defective component thereof) there is no responsibility for the matching of color, grain, fabric, or texture except to within commercially acceptable standards, as determined by Hussey Seating in its sole discretion. **THERE ARE NO OTHER WARRANTIES OTHER THAN THOSE EXPRESSLY STATED ABOVE, WHETHER EXPRESSED OR IMPLIED (INCLUDING, BUT NOT LIMITED TO, ANY WARRANTY OR MERCHANTABILITY OR FITNESS FOR ANY PARTICULAR PURPOSE) UNLESS SPECIFICALLY AGREED TO IN WRITING BY AN OFFICER OF HUSSEY SEATING IN THE SPECIFIC CIRCUMSTANCE.** Hussey Seating is not liable (in contract, tort, or otherwise) for any consequential, special, direct, punitive, or incidental damage.

WARRANTY NOTICE ADDRESS: **Hussey Seating Company**
Attn: Product Warranty
38 Dyer Street Ext.
North Berwick, Maine 03906 USA

Product Line Warranty: MAXAM1, MAXAM, MAXAM+, MXP, CourtSide & Classic Wood Seating Collections



PORTABLE BLEACHERS



husseyseating[™]

YOUR PARTNER FOR SEATING SOLUTIONS



Portability, Flexibility and Safety – All In One! Introducing **MAXAM 1™** Portable Bleachers

The next generation in portable bleacher seating is MAXAM 1™. Designed to be the safest and most comfortable portable bleachers available, MAXAM 1™ Portable Bleachers quickly bring the safety, comfort and durability of large gym bleacher systems to nearly any spot on your facility's campus.

One person. MAXAM 1™ Portable Bleachers are designed for quick & easy one-person transport and one-person operation. Hussey's legendary attention to detail means MAXAM 1™ was created with your environment in mind – whether that means fitting through tight doorways and onto elevators, or providing the safest portable bleacher system to own and operate.

One design. As the first – and only – closed deck portable bleachers to offer ergonomically contoured polymer seats, MAXAM 1™ delivers unmatched comfort. MAXAM 1™ Portable Bleachers aesthetically match our MAXAM telescopic bleachers for a seamless gymnasium appearance. Easily pump up the spirit with our customization options; you can even choose the decking material that works best for you.

Get the one changing the game. Take the great quality and durability of MAXAM anywhere you want to go – our tough yet lightweight aluminum frame means you can use MAXAM 1™ virtually anywhere*. Take your seating from courtside to rink-side, indoor pool to cafeteria, auditorium stage to meeting room with a new level of ease, safety and comfort backed by a best-in-class 5-year manufacturer's warranty.



One simple move. Designed to fit through multi-directional casters make it easy to move outside anymore – take MAXAM 1™ common freight elevators or large cap floor to floor.

Engineered for Easy Use Facility-Wide.



One minute – one person. We engineered MAXAM 1™ Portable Bleachers to be operated by a single person. Just extend each of the traction arms, tip the unit, give it a gentle push to lock it down, and it is ready to go. Gas struts provide a controlled descent and lift assistance to ensure easy operation. No more waiting for a crew or scheduling extra labor – just keep saving labor time and cost for the entire life of your seats.



One answer – anywhere. MAXAM 1™ colleges, fitness clubs, retail & corpor sports fields and playgrounds. Handli together. You can even use it outdoor outside the gym!

Get Seating with More Safety and Comfort.



One safe solution— anywhere, anytime! Safe seating is our first priority as well as yours. MAXAM 1™ sets a new standard for tip & roll bleachers by featuring a closed deck design to eliminate fore to aft openings and actively prevent foot slip-through injuries. Choose from classic wood decking or slip-resistant Polydeck in several colors. The gas strut controlled descent and lift assistance prevents back injuries and limit liability.



One comfortable solution. Comfortable portable bleachers are no longer a dream with MAXAM 1's™ CourtSide™ polymer seat modules. Incorporating a unique fore to aft contoured seat and a gradual "waterfall" curve on the forward edge, they reduce pressure to the thighs regardless of leg position. Seat spacers with or without cup holders are also available.



Complete Customization Options.



The end of each seat row offers a spot for your school's logo, mascot, or spirit message. These durable graphic logos are full-color and customizable.

Choose from over 15 standard colors for our CourtSide™ seat modules, or opt for custom color matching to turn up the school spirit.



Dimensional Data

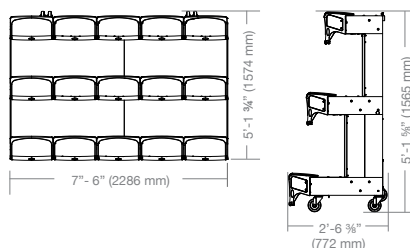

Resources

For all accessories, surface materials, fast facts, environmental data sheets and more go to HusseySeating.com/maxam1

Warranty

5 year factory-backed warranty - the best in the industry.

MAXAM 1™ Portable Bleachers fit in just about anywhere – schools, athletic training areas, recreation facilities, community centers, and large groups is easy – simply connect multiple units temporarily in protected areas*. Get creative, and think

* This is a weather resistant bleacher only – it is not warranted to be weather proof. Hussey Seating does not recommend keeping or storing bleachers outdoors where they are exposed to rain or other extreme weather. Hussey Seating's warranty does not cover defects caused by exposure to rain or other extreme weather conditions.

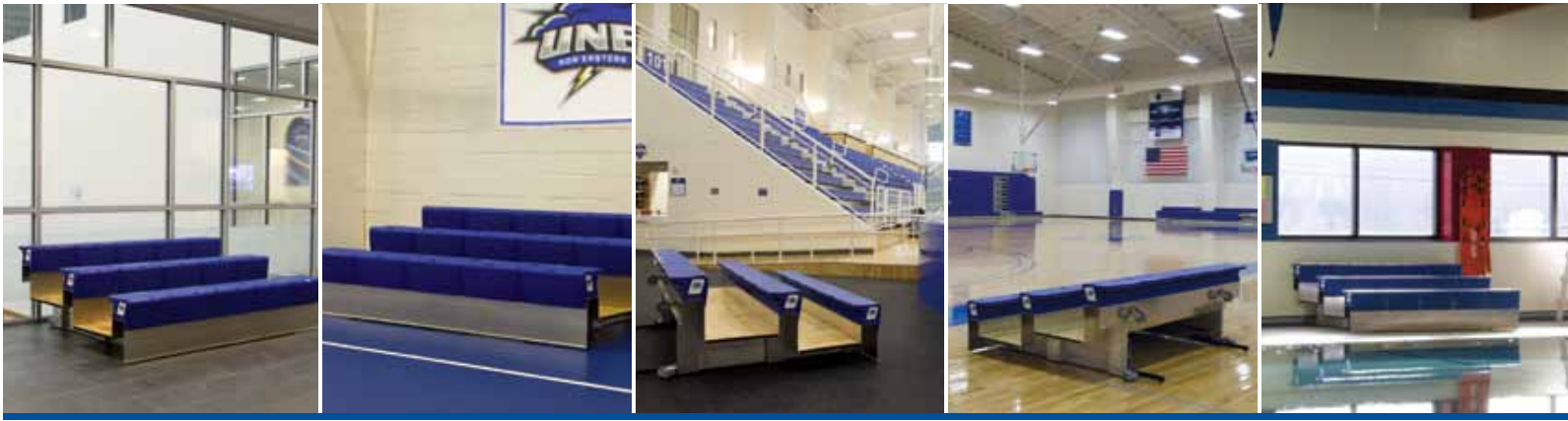

MAXAM 1™



Hussey Seating Company™

The Hussey Seating Company story dates back to 1835 with William Hussey's tremendously successful plow design, and thus, the Hussey Plow Company was born. As times changed over the next sixty years, the family set about reinventing the business, evolving into the company that is now seating the world. Today, under the sixth generation of family leadership, Hussey Seating Company is proud to be known as the leading manufacturer of seating solutions throughout the world – in stadiums, arenas, schools, universities, colleges, places of worship and anywhere people gather.

Hussey. Your partner for seating solutions.

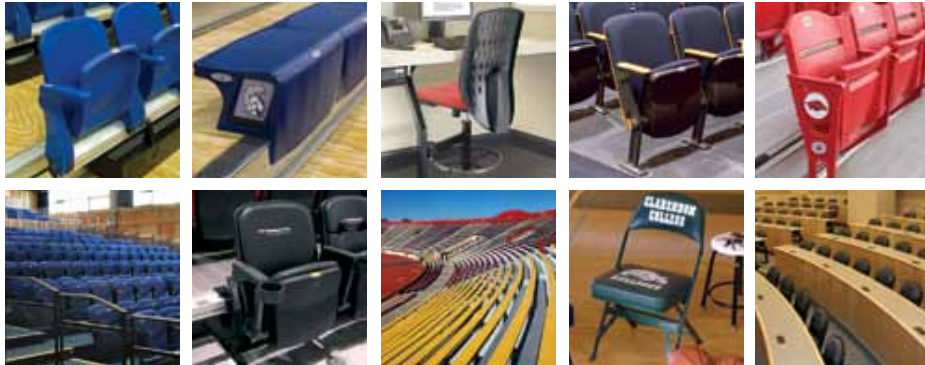

husseyseating™

YOUR PARTNER FOR SEATING SOLUTIONS

38 Dyer Street Extension
 North Berwick, Maine 03906 USA
 Toll Free (USA) 1.800.341.0401
 Tel: +1.207.676.2271 • Fax: +1.207.676.2222
info@husseyseating.com • www.husseyseating.com





New Lebanon High School - Lebanon, OH

CONTINUOUS ANGLE FRAME Bleachers



Wild Horse Pass Arena - Chandler, AZ



Schertz-Cibolo ISD - Cibolo, TX



McLennan Community College - Waco, TX

Standard or Custom Solutions

Designed for installation on flat and level surfaces, standard Angle Frame Bleachers are offered in 5, 8, 10, 15 and 20 rows. Our standard designs can be custom engineered for your specific site and seating needs.

Accommodates Expansion

As your facility and seating requirements increase, this type of bleacher system provides the flexibility of adding additional seats to continually meet the demand.

Versatility

Can be customized to accommodate various seating options including benches with straight backs, individual VIP chairs and armrest to designate exact seating for reserved areas.

An Economical Standard

For the ultimate in cost effective spectator seating, standard Angle Frame Bleachers provide the top quality features you expect, at a cost that will fit any budget for indoor and outdoor venues.

Recommended for:

- | | | |
|----------|-------------|----------|
| Football | Baseball | Softball |
| Soccer | Lacrosse | Tennis |
| Track | Motorsports | Aquatic |
| Rodeo | Exposition | Ice Rink |



Economical & versatile seating for all indoor and outdoor venues.



Structure

Our standard Angle Frame bleachers are built using a galvanized steel box frame construction that includes cross bracing and stringers spaced at 6 feet on center. Offered in both elevated or non-elevated applications and optional aluminum frame understructure.

Finish Applications

Standard features include anodized aluminum seating and risers, semi-closed or closed mill finished decks. Options include bench seating with straight backs or VIP chairs, press boxes, ramps, stairs or walkways.

Warranty

All Sturdisteel Products are warranted for five years beginning at date of substantial completion of project - free from defect in materials and workmanship in the course of manufacture. This warranty excludes any other defects resulting from abnormal use, accidental or intentional damage or any occurrences beyond manufacturer's control.



Gross Seating Capacities

Gross seating is based on 18" per seat and is the total seating area (total rows multiplied by seating area length, divided by 1.5"). Net seating is the gross seating, less the seating lost due to aisles and handicap spaces requirements, and will vary based on local building code requirements. Net Seating is approximately 85% of Gross Seating and is the actual seating capacity.

LENGTH	3 ROWS	4 ROWS	5 ROWS	8 ROWS	10 ROWS	15 ROWS
15'	30	40	50	80	100	150
21'	42	56	70	112	140	210
27'	54	72	90	144	180	270
33'	66	88	110	176	220	330
39'	78	104	130	208	260	390
45'	90	120	150	240	300	450
51'	102	136	170	272	340	510
57'	114	152	190	304	380	570
63'	126	168	210	336	420	630
69'	138	184	230	368	460	690
75'	150	200	250	400	500	750
81'	162	216	270	432	540	810
87'	174	232	290	464	580	870
93'	186	248	310	496	620	930
99'	198	264	330	528	660	990
105'	210	280	350	560	700	990
111'	222	296	370	592	740	1110
117'	234	312	390	624	780	1170
123'	246	328	410	656	820	1230
129'	258	344	430	688	860	1290
135'	270	360	450	720	900	1350
153'	306	408	510	816	1020	1350
177'	354	472	590	944	1180	1770
195'	390	520	650	1040	1300	1950
213'	426	568	710	1136	1420	2130
231'	462	616	770	1232	1540	2310



P.O. Box 2655, Waco, TX 76702-2655

TEL: 254.666.5155

FAX: 254.666.4472

TOLL FREE: 800.433.3116



Sturdisteel is a Division of Schultz Industries, Inc.



CARDINAL **Series 3000**



Stadium Chairs

For the ultimate in aesthetics and comfort, the Cardinal Series chairs are a premium choice for all sporting venues requiring a reserved section or VIP seating.

Our ergonomic self-rising stadium chair meets industry standards for audience safety, rugged durability and easy maintenance.

Chairs are available with or without armrest and cup holders and offered a in a range of standard and custom colors.

Features:

- Self-rising, gravity-tip and maintenance-free high grade polyethylene containing antistatic and ultra-violet protection
- Three frame finishes: Galvanized, Black (shown), Hammered Antique Grey
- Offered in 19", 20", 21", 22" center to center
- Five Year Limited Warranty

Standard Colors



While Sturdisteel has made every effort to represent our standard colors as accurate as possible, these are intended as a guide only and should not be regarded as absolutely correct. If you would like to see a color sample of any product, please call our toll free number.



Sturdisteel is a Division of Schultz Industries, Inc.

P.O. Box 2655, Waco, TX 76702-2655

TEL: 254.666.5155

FAX: 254.666.4472

TOLL FREE: 800.433.3116



www.Sturdisteel.com



EAGLE Series 1000

Bleacher Seats

Sturdisteel Eagle Series 1000 bleacher seats are a value choice for sporting venues requiring a reserved section for installation on existing or new plank aluminum seating.

Our ergonomic polyethylene seat is designed for comfort and longevity, giving the spectator a defined seat space. Generate revenue for your school, team or organization by adding optional engraved names plates.

Eagle seats are available in four standard colors and custom colors for a minimum of 1000 units.

Features:

- High grade polyethylene containing antistatic and ultra-violet protection
- Recessed hardware and drainage slot
- Number plate and optional name plate available for fund-raising
- Installs on 10" square aluminum seating plank
- Five Year Limited Warranty



While Sturdisteel has made every effort to represent our standard colors as accurate as possible, these are intended as a guide only and should not be regarded as absolutely correct. If you would like to see a color sample of any product, please call our toll free number.



Sturdisteel is a Division of Schultz Industries, Inc.

P.O. Box 2655, Waco, TX 76702-2655

TEL: 254.666.5155

FAX: 254.666.4472

TOLL FREE: 800.433.3116



www.Sturdisteel.com

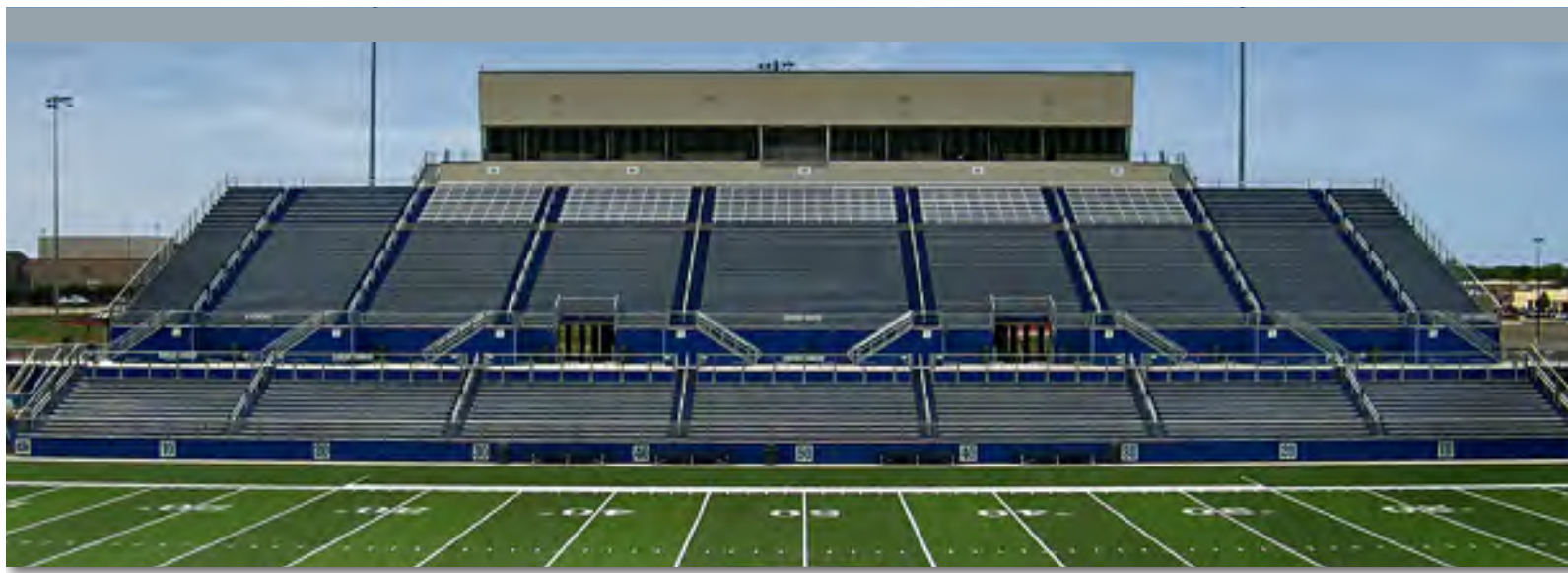

Bernard Birkelbach Field - Georgetown, TX

I-BEAM Permanent Grandstands



ERAU - Daytona Beach, FL



Gladewater Arena - Gladewater, TX



TAMU - College Station, TX

Custom Solutions

Designed specifically for your site and seating requirements, Permanent Grandstands can be installed on difficult sites such as hillsides or berms. Sturdisteel also offers professional engineering services to adapt any of our standard designs to your specific needs.

Maximized Space

Clear-span understructure allows for spacious room underneath the grandstand for storage, restrooms, concessions, locker rooms, etc.

Versatility

Accommodates various rises and treads requirements, all decking designs and other features such as stadium chairs and weather shields.

The Industry Standard

I-Beam Permanent Grandstands are the industry standard for premium outdoor spectator seating - engineered and constructed to withstand daily use, regardless of weather conditions, size of crowd or type of event.

Recommended for:

- | | | |
|----------|-------------|----------|
| Football | Baseball | Softball |
| Soccer | Lacrosse | Tennis |
| Track | Motorsports | Aquatic |
| Rodeo | Exposition | Ice Rink |



Accommodating crowds from just a few hundred spectators to 10,000 or more.



Structure

Our standard Permanent Grandstands are engineered to be installed on concrete pier foundations and combine wide-flange steel vertical supports on 18 foot centers and horizontal support beams.

Finish Applications

Options include roofing over seating areas, press box support structures, aluminum seat boards, foot boards, riser boards, and various types of VIP seating.

Warranty

All Sturdisteel Products are warranted for five years beginning at date of substantial completion of project - free from defect in materials and workmanship in the course of manufacture. This warranty excludes any other defects resulting from abnormal use, accidental or intentional damage or any occurrences beyond manufacturer's control.



Gross Seating Capacities

Gross seating is based on 18" per seat and is the total seating area (total rows multiplied by seating area length, divided by 1.5"). Net seating is the gross seating, less the seating lost due to aisles and handicap spaces requirements, and will vary based on local building code requirements. Net Seating is approximately 85% of Gross Seating and is the actual seating capacity.

LENGTH	10 ROWS	16 ROWS	22 ROWS	28 ROWS	34 ROWS	40 ROWS
30'	200	320	440	560	680	800
48'	320	512	704	896	1088	1280
66'	440	704	968	1232	1496	1760
84'	560	896	1232	1568	1904	2240
102'	680	1088	1496	1904	2312	2720
120'	800	1280	1760	2240	2720	3200
138'	920	1472	2024	2576	3128	3680
156'	1040	1664	2288	2912	3536	4160
174'	1160	1856	2552	3248	3944	4640
192'	1280	2048	2816	3584	4352	5120
210'	1400	2240	3080	3920	4760	5600
228'	1520	2432	3344	4256	5168	6080
246'	1640	2624	3608	4592	5576	6560
264'	1760	2816	3872	4928	5984	7040
282'	1880	3008	4136	5264	6392	7520
300'	2000	3200	4400	5600	6800	8000
318'	2120	3392	4664	5936	7208	8480
336'	2240	3584	4928	6272	7616	8960
354'	2360	3776	5192	6608	8024	9440
372'	2480	3968	5456	6944	8432	9920
390'	2600	4160	5720	7280	8840	10400
408'	2720	4352	5984	7616	9248	10880
426'	2840	4544	6248	7952	9656	11360
444'	2960	4736	6512	8288	10064	11840
462'	3080	4928	6776	8624	10472	12320
480'	3200	5120	7040	8960	10880	12800



P.O. Box 2655, Waco, TX 76702-2655

TEL: 254.666.5155

FAX: 254.666.4472

TOLL FREE: 800.433.3116



Sturdisteel is a Division of Schultz Industries, Inc.

www.Sturdisteel.com



Palo Verde High School - Tucson, AZ

LEG TRUSS Permanent Grandstands



Borah High School - Boise, ID



Henry Ford High School - Detroit, MI



San Patricio County Rodeo - Sinton, TX

Standard or Custom Solutions

Designed specifically for your site and seating requirements, Leg Truss Grandstands can be installed on difficult sites such as hillsides or berms or other conditions that are unsuitable for frame-type bleachers. Our standard designs can also be engineered for your specific site and seating needs.

Accommodates Expansion

Understructure provides limited usable space beneath the grandstand for storage, restrooms, concessions, etc., at a more affordable price than an I-Beam grandstand.

The Industry Standard

Leg-Truss Permanent Grandstands are a custom designed hybrid between a

permanent grandstand and frame-type system - engineered and constructed to withstand daily use, regardless of weather conditions, size of crowd or type of event.

Recommended for:

- | | | |
|----------|-------------|----------|
| Football | Baseball | Softball |
| Soccer | Lacrosse | Tennis |
| Track | Motorsports | Aquatic |
| Rodeo | Exposition | Ice Rink |



A cost-effective solution for accommodating large crowds.



Structure

Our standard Leg Truss Permanent Grandstands are installed on concrete slab or gradebeam foundations and combine wide-flange stringers, steel angle columns and bracing spaced at 6 feet on center.

Finish Applications

Standard features include anodized aluminum seating and risers, semi-closed or closed mill finished decks. Options include bench seating with straight backs or VIP chairs, press boxes, ramps, stairs or walkways.

Warranty

All Sturdisteel Products are warranted for five years beginning at date of substantial completion of project - free from defect in materials and workmanship in the course of manufacture. This warranty excludes any other defects resulting from abnormal use, accidental or intentional damage or any occurrences beyond manufacturer's control.

Gross Seating Capacities

Gross seating is based on 18" per seat and is the total seating area (total rows multiplied by seating area length, divided by 1.5"). Net seating is the gross seating, less the seating lost due to aisles and handicap spaces requirements, and will vary based on local building code requirements. Net Seating is approximately 85% of Gross Seating and is the actual seating capacity.

LENGTH	10 ROWS	13 ROWS	15 ROWS	18 ROWS	20 ROWS
30'	200	260	300	360	400
48'	320	416	480	576	640
66'	440	572	660	792	880
84'	560	728	840	1008	1120
102'	680	884	1020	1224	1360
120'	800	1040	1200	1440	1600
138'	920	1196	1380	1656	1840
156'	1040	1352	1560	1872	2080
174'	1160	1508	1740	2088	2320
192'	1280	1664	1920	2304	2560
210'	1400	1820	2100	2520	2800
228'	1520	1976	2280	2736	3040
246'	1640	2132	2460	2952	3280
264'	1760	2288	2640	3168	3520
282'	1880	2444	2820	3384	3760
300'	2000	2600	3000	3600	4000
318'	2120	2756	3180	3816	4240
336'	2240	2912	3360	4032	4480
354'	2360	3068	3540	4248	4720
372'	2480	3224	3720	4464	4960
390'	2600	3380	3900	4680	5200
408'	2720	3536	4080	4896	5440
426'	2840	3692	4260	5112	5680
444'	2960	3848	4440	5328	5920
462'	3080	4004	4620	5544	6160
480'	3200	4160	4800	5760	6400



P.O. Box 2655, Waco, TX 76702-2655

TEL: 254.666.5155

FAX: 254.666.4472

TOLL FREE: 800.433.3116



Sturdisteel is a Division of Schultz Industries, Inc.



LOW PROFILE Portable Bleachers

Rows	Length	Net Seats
3	7'-6"	15
3	15'-0"	30
3	21'-0"	42
3	27'-0"	54
4	7'-6"	20
4	15'-0"	40
4	21'-0"	56
4	27'-0"	72

Exceptional Value

Sturdisteel low-profile portable bleachers provide economical portable seating for a variety of indoor and outdoor venues. Our portable bleachers are constructed of the finest materials available and meet all building code requirements without aisles, guardrail systems or decking risers.

Features:

- 3 or 4 Row
- Aluminum or galvanized steel angle frame
- 2 x 12 aluminum seat boards
- 2 x 10 single footboards
- 6" rise with 24" tread
- 30" or less in height
- Available with double footboards and risers
- Five Year Limited Warranty



Sturdisteel is a Division of Schultz Industries, Inc.

P.O. Box 2655, Waco, TX 76702-2655

TEL: 254.666.5155

FAX: 254.666.4472

TOLL FREE: 800.433.3116



www.Sturdisteel.com



TELESCOPIC GYMNASIUM SEATING



husseyseating™

YOUR PARTNER FOR SEATING SOLUTIONS

MAKE YOUR SPACE MORE FUNCTIONAL

Hussey Seating has a long tradition of providing high quality telescopic seating designed to deliver the maximum flexibility from any gymnasium or multi-use space.

We also know that the key to developing and providing the perfect telescopic seating solution is an understanding of each customer's unique needs.

Collaborating with our customers and applying our seating expertise delivers a seating solution that makes the most of your multi-use space every single day – not just game day.

MAXAM® TELESCOPIC GYM SEATING

SOLUTIONS	APPLICATIONS
The Total Package 3-6	Wall Attached 13
Flex-Row™ 7-8	Reverse-Fold 14
Bleacher Seating Solutions 9-10	Recessed 15
Row Spacing 11	Portable & Free-standing 16
Seat Options & Customization 11-12	Understructure 17-18
	Component Options & Acc. 19-20
	Dimensional Data 21
	Resources 22

Cover Photo:
MAXAM Telescopic Gym Bleacher w/ XtremeLogo
CSU Bakersfield • Bakersfield, CA
Herk Edwards

GREAT PERFORMANCES

When you specify MAXAM®, you get seating performance that exceeds expectations. No one offers a broader range of features, accessories, and engineering options to meet your seating needs than your Hussey™ dealer. No one knows more about maximizing your capacity and multi-use adaptability.

MAXAM gives you an independently certified design, a Hussey factory-trained and certified installation team, and also offers factory-backed maintenance, repair & renovation for the actual life of the product.

Our rock-solid dealer relationships and rigorous product training are unique in the industry. That means Hussey and our dealers stand confidently behind you and your project at each and every critical step, from proposal through design, installation, and beyond.

Put the expertise of your Hussey dealer and all the resources of Hussey Seating Company™ to work for you.

MAXAM Telescopic Gym Bleacher w/ XtremeLogo
Stanwood High School • Stanwood, WA
Nor-Pac Seating

THE TOTAL PACKAGE

From our brand new XtremeLogo™ bleacher graphics that make your gym come alive to our Clarin® portable logo chairs, the Total Package Graphics Program helps create the ultimate gymnasium. Inspire your team, students and community with vibrant colored rails, spirited CourtSide™ Contour Backrests, integral CourtSide seat graphic logos, vivid Safety End Closure Curtain graphics, exciting Media Platform Rail Sleeve graphics, and our sleek new StepSigns™ and CourtSigns™. The customization options are nearly endless!

"The bleachers have generated a great deal of school pride with our student body. The kids are so proud when players from opposing schools come into the gym and comment on how beautiful the bleachers are. They've turned a nice gym into a state of the art gym...it's stunning!"

Dennis Walton, CAA, Athletic Administrator
Biddeford High School, Biddeford, Maine



MAXAM® Telescopic Gym Bleacher w/ The Total Package
Biddeford High School • Biddeford, ME
Harriman Associates



XtremeLogo
The cornerstone of the Total Package Graphics Program, the XtremeLogo places your school's mascot or logo on a grand scale in the center of your bleacher sections. Using a proprietary graphic transfer process, your XtremeLogo is permanently bonded to the CourtSide bleacher seats – no peeling, scuffing or scratching. Whether the bleachers are opened or closed, your logo will impress.

Clarin Portable Sideline Chairs
The choice of colleges and pro teams nationwide, Clarin portable chairs offer state-of-the-art logo customization for backs, seats and even seat gussets. Durable, full-color imprints of your mascot, logo, and spirit message give big-league sideline impact. Clarin's proven worry-free dependable performance is legendary, delivering decades of service with the flexibility of interchangeable seats and backs.

CourtSide™ Graphic Logos
CourtSide gym seat modules offer a spot for every fan to see your school's logo or mascot at the end of each seating area. These durable, full-color custom graphic logos can even be individually customized for section designation.



StepSigns™
These ultra-durable full-color signs are pre-applied to the front of bleacher aisle steps during manufacturing. Offering full-color to single color imprinting, they are a great place to remind students, fans and competitors of your school motto or spirit message.

CourtSigns™
Featuring the same material and imprinting options as StepSigns, CourtSigns are pre-applied to the bleacher skirt boards during manufacturing. Their longer runs and placement make them ideal for ringing the court with your school name.

Media Platform
The rail sleeves of both detachable or permanently installed Media Platforms are the perfect spot to bring together your full-color logo, mascot, school name and spirit message to top off your bleachers with a message visible from anywhere in your gym.

THE TOTAL PACKAGE (cont.)



Portable Chair Storage Carts

Put an end to haphazard sideline chair storage with our specially engineered Clarin® chair storage carts. Make set-up and break down a breeze by using stacking, hanging, flat or studio carts to keep your chairs organized and all in one place.



Backrests and Seat Spacers

Contrasting color CourtSide™ CB contoured bleacher backrests deliver truly comfortable bleacher seating and turn up the spirit. They can be incorporated anywhere on your bleachers, with or without seat spacers.



Safety End Closure Curtain

MAXAM® bleacher end curtains boost gym security while displaying your school pride. Vibrant full-color customization can run all the way off the edges in large full-bleed designs to wow people with your spirit as soon as they walk in the door.

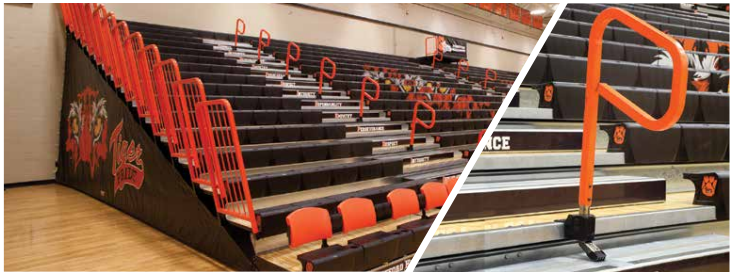

Auto-Rotating Center Aisle Rails

This Patent pending rail is permanently mounted to the bleacher, and automatically rotates to the proper open or closed position as you operate the bleacher with the push of a button. No tools, no labor, no more missing or improperly positioned rails.



Colored Rails

Your bleacher aisle, end, front and rear rails carry on your school's color scheme in one or more colors. Choose from a variety of standard color options or custom color matching to bring out school pride with a punch of color.

XTREMELOGOS™



FLEX-ROW™

Flex-Row is the crowning achievement of MAXAM®. It paves the way for your facility to easily accommodate the most challenging team sport and public access seating requirements. Create an endless variety of configurations to accommodate constantly changing needs like team seating, wheelchair access and scorer's tables.

Over time, seating codes, standards and regulations change. Why not give telescopic users the maximum flexibility to respond? Flex-Row™ is the answer, a bold stroke in quick utility.

In its unused position, Flex-Row maintains a standard telescopic bleacher appearance. In only minutes, you can easily re-configure your first bleacher row into any number of lock-in layouts to provide a variety of ADA solutions instead of just one. From a single wheelchair with a seated companion all the way up to a group of several wheelchairs, Flex-Row can handle them all.



MAXAM® Telescopic Gym Bleacher w/ CourtSide™ Seats
University of New England • Biddeford, ME
Sasaki Associates, Inc.



Easy-access activator, no remote or operation pendant required

Flex-Row also can open up bleacher cut-outs to provide a space for portable team sideline seating and scorer's tables. No matter what the use, Flex-Row features fully enclosed skirting to provide an added measure of safety for fans and students while keeping debris out from under the bleachers. Your Flex-Row can even include backrests to create VIP sideline seating that is fully retractable, or to provide integral visiting team seating.

Flex-Row keeps delivering benefits after the game too. When the entire bank of bleachers is closed, Flex-Row can be pulled out to provide the day-to-day gymnasium seating demanded by coaches, teams and P.E. classes. In these situations, Flex-Row naturally limits student climbing behaviors by providing a convenient place to sit and put book bags.

No matter what the use, you do not need keys, special tools, power, remotes or pendants to operate Flex-Row. The concealed mechanism is easy to operate with just a pull of a lever by your facility staff, coaches or even your faculty.



Standard open bleacher arrangement

Open bleachers using Flex-Row to create ADA seating and scorer's table areas



Closed bleachers using Flex-Row for practice team seating

BLEACHER SEATING SOLUTION

Hussey's telescopic bleachers can be topped with a variety of different seating solutions. Choices range from classic wood benches to individual polymer seat modules, backrests, seat spacers and even cup holder options. With all of the seating and row spacing options available for MAXAM®, you can leave cookie-cutter bleachers behind and get the perfect bleacher system to match your facility's specific needs.



MAXAM Telescopic Gym Bleacher with CourtSide™ Seats and Backrests
University of Findlay • Findlay, OH
Farnham Equipment Company



CourtSide CB Contoured Backrests

CourtSide XT Seat Spacer

A New Dimension of Comfort

Comfortable bleachers are no longer a dream, courtesy of Hussey's CourtSide™ modular gym seat line. Seat modules, contour backrests and seat spacers are just the ticket for seating spectators in truly comfortable bleacher seats – a welcome surprise for your fans.

CourtSide is completely modular, and using any piece of the CourtSide line will deliver an enhanced level of comfort to your bleacher seats. You can use all three types of modules throughout your gym, or mix and match to create different levels of seating within the same bleacher bank. Easily create a first row of integrated team seating, or build a section of reserved VIP seating for season ticket sales to your boosters.

Hussey's CourtSide modular gym seat line includes two sizes of contoured seat modules, CourtSide CB contoured backrests, and CourtSide XT Seat Spacers, either with or without cup holders.

CourtSide CB backrests are ergonomically designed for maximum comfort. While cheering on the team, spectators can lean back and enjoy ideal low- and mid-back support. CB backrests are also designed for maximum fan safety and easy bleacher cleaning. One person can raise or lower up to seven interconnected backrests at a time, which minimizes labor and operational costs.

CourtSide XT seat spacers increase personal space by nearly 25%. This truly comfortable individual seat space better accommodates larger people who appreciate extra elbow room. Cup holder versions are available so you can maximize fan comfort and convenience.

Like all Hussey products, our CourtSide comfort features are engineered for quality and ease of use.

ROW SPACING

MAXAM® offers three different row spacing choices depending on capacity expectations. Standard dimensions are 22" (559 mm), 24" (610 mm), and 26" (660 mm). For larger gymnasiums or collegiate facility dimensions, MAXAM+™ allows for 30" (762 mm), 32" (813 mm) or 33" (838 mm) row spacing. As the row spacing increases, the required actual seat width decreases, influencing true seating capacity.

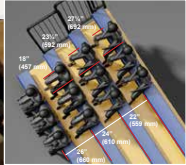

MAXAM® Telescopic Gym Bleacher with CourtSide Seats
Baker High School • Baker City, OR
Nor-Pac Seating

Seating Options



CourtSide™ XCS12
The world's only ergonomically designed gym seat module, the CourtSide XCS12 provides an individualized compound contoured seat that incorporates modern styling, dual texturing and waterfall edges. 12" (305 mm) wide and manufactured from 100% recyclable materials, the CourtSide is the perfect blend of ergonomic comfort, modern design, performance and value.

CourtSide XC10
CourtSide XC10 incorporates a unique fore to aft contoured seat and a gradual "waterfall" curve on the forward edge that reduces pressure to the sensitive region of the thighs regardless of the leg position. 10" (254 mm) wide. 100% recyclable.

Classic Wood
All our wood boards are finger-jointed Southern Pine Grade "B&B", the finest available. Each is triple sanded and finished with two separately UV cured coats of urethane.

Seating Customization



Fold-Down Bleacher Chairs
Do you need fold-down chairs on your telescopic platforms? Look no further than our MAXAM+™ telescopic platforms with 30" to 33" (762 mm - 838 mm) row spacing. Our comfortable and stylish Metro™ chairs are available on just a few rows or your entire MAXAM+ system. Metro chairs are available in upholstered or all-polymer versions, and fold and store in the unit when closed. Available with either semi-automatic or foot assist operating mechanisms.

Standard Colors
The CourtSide™ XC10 and XCS12 are available in 15 standard colors. For accent lines, attention-grabbing signature logos or sticking with a solid color theme, CourtSide is your ideal seat. Production plastic and powder coat colors can vary from printed samples shown, so Hussey makes sample chips available upon request. Custom color matches are also available.

Signature Logo Program
Your local Hussey dealer will work with your community or school to develop a logo design that makes everyone proud. With the MAXAM Signature Logo Program, it is easy to create the most colorful and spirited bleacher logo design.

WALL ATTACHED

Our most popular telescopic gym seating solution. Wall attached systems are supplied in 3 to 30 tier banks, are extremely adaptable, and efficiently recover floor space, allowing you to easily get the most out of your facility at all times.

MAXAM® Telescopic Gym Bleacher w/ XtremeLogo
 Foothill High School • Santa Ana, CA
 Herk Edwards

REVERSE-FOLD

Often utilized for balcony seating areas, reverse-fold systems retract from back to front to create additional space behind the unit. This space can be used for practice areas, batting cages, volleyball, gymnastics or any wide array of uses. Add back panels for a cleaner look, more versatility and improved safety.

MAXAM® Telescopic Gym Bleacher
 Talawanda High School • Oxford, OH
 Fambam Equipment Company



Wall Attached Closed

Pendant Control
 Pendant controls allow the operator to see the entire bank as it opens and closes—an important safety precaution. The pendant control can be easily removed to prevent unauthorized use.

Wireless Remote Control
 All of the built-in safety features of our standard pendant control, with the additional convenience and freedom of movement offered by wireless operation.



Reverse-Fold Closed

Reverse-Fold Open

Reverse-Fold Delayed Action
 Further increase your usable space by up to 3' (914 mm) with MAXAM's delayed action feature. The entire closed bleacher stack moves forward on a linkage to recover additional floor space.

RECESSED

This system utilizes a pocket in the wall to house the bleacher when closed. The ends may or may not be exposed, and the bleacher is hidden from view typically under a balcony or mezzanine.

Recessed bleachers are outfitted with upper and lower tracking guides, removable end rails, and can accommodate custom transition steps to the balcony when required.

MAXAM™ Telescopic Platform with Metro™ Chairs
 Reynoldsburg High School • Reynoldsburg, OH
 Farnham Equipment Company

Recessed Open

PORTABLE & FREESTANDING

Portable

These bleacher sections allow you to easily move and store bleachers where you want them. Create any number of custom seating layouts for different events. Units may be equipped with locking floor pintels for extra safety and security.

Freestanding

With a heavier rear column that's permanently secured to the floor, these bleachers provide design flexibility for buildings that can't support wall loading or where wall loading is marginal.

MAXAM™ Telescopic Gym Bleacher
 Providence Career Technical Academy • Providence, RI
 Robert H. Lord-Company

Traveling Units



A hybrid of recessed and portable banks, traveling units use integral power to drive the entire bank from one setup position to another. Set-up time is greatly reduced compared to individual portable sections.



One minute – one person. We engineered MAXAM 1™ Portable Bleachers to be operated by a single person. Just extend each of the traction arms, tip the unit, give it a gentle push to lock it down, and it is ready to go. Gas struts provide a controlled descent and lift assistance to ensure easy operation. No more waiting for a crew or scheduling extra labor – just keep saving labor time and cost for the entire life of your seats.



One answer – anywhere. MAXAM 1™ Portable Bleachers fit in just about anywhere – schools, colleges, fitness clubs, retail & corporate training areas, recreation facilities, community centers, sports fields and playgrounds. Handling larger groups is easy – simply connect multiple units together. You can even use it outdoors temporarily in protected areas*. Get creative, and think outside the gym!

UNDERSTRUCTURE

Performance, Flexibility and Safety



A. Posi-Lock™ LX

These automatic row locks prevent accidental closure when the system is in use. This patented, innovative, low-profile design minimizes the chance of accidental damage, ensuring consistent operation.

B. Nose & Riser Beam

These rolled form structural members provide continuous deck support, and are through-bolted to the frame and stabilizers. These designs deliver unparalleled strength, durability and rigidity.

C. Continuous Positive Interglide

This interlocking glide system is a rigid, one-piece formed design which tracks better and operates easier than systems with 1/2" (13 mm) row to row engagement. The 10" (254 mm) minimum interlock provides the industry's most rigid, stable design. Our wheels are 5" (127 mm), resulting in less rolling friction.

D. Captive Interlock & Adjustable Row Stops

The Captive Interlock System engages and aligns deck to deck. In addition, MAXAM® can be configured for three different row-spacing setups—adjustable on-site if required. MAXAM incorporates three stabilizer assemblies per section to provide improved tracking and stability.

E. Independently Locking Flex-Row™

Each Flex-Row is equipped with an independent self-locking mechanism to deliver maximum flexibility, performance and safety.

F. Full-Length Captured Decking

Decking is captive in the riser beam and rests on the nose, firmly secured by the seat bracket. This system provides a stiff, secure walking surface with no exposed hardware. MAXAM is the only telescopic gym seat that utilizes transverse decking, using decking materials in accordance with their industry span rating. Thoroughly load tested and independently verified, MAXAM's continuous full-length deck support system provides an enhanced level of performance, safety and stability.

G. Slant Frame Design

Load-tested and certified for 30 tier single stack sections up to 25' 6" (7772 mm), our slant frame design delivers improved cantilever strength and capacity. It also simplifies the installation process, reducing downtime for the facility. Critical support areas are all fastened with bolts, lock washers and hex nuts. Only MAXAM incorporates a steel to steel connection where the frame meets the wall, creating a stronger union and a safer gym seat.

H. Tension Bracing

Through bolted to the frame to provide additional stability. All bracing is coined to remove sharp edges, and all ends are rounded for safety.

Rail Options



New Auto-Rotating Center Aisle Rails

Hussey's breakthrough center handrail design ensures your patrons will always find a secure hand hold while moving up or down the aisles – while dramatically reducing the labor of properly opening or closing your gym bleacher. This Patent pending rail is permanently mounted to the bleacher, and automatically rotates to the proper open or closed position as you operate the bleacher with the push of a button.

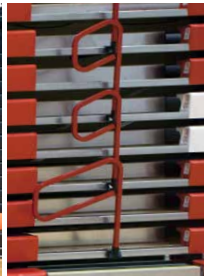

Colored Rails (Left)

Carry your color scheme throughout the facility with one or more of our palette of standard colors to show your school spirit. Aisle rails, end rails and front or rear rails can all be customized to match your school colors. Ask your Hussey dealer for more information.

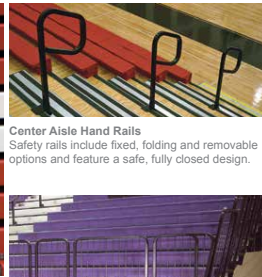

Center Aisle Hand Rails

Safety rails include fixed, folding and removable options and feature a safe, fully closed design.



Fixed Front and Rear Rails

An ideal solution for truncations, elevated front aisles, freestanding, portables and reverse fold systems. All rails maintain a consistent design appearance.

Media Platform

Perfect for videotaping, photography, radio broadcasting or team talent scouting, the Hussey Media Platform creates a workable space for covering all the action. Optional rail sleeves can be customized to promote school spirit or generate revenue.

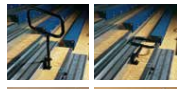

Fold & Stow Center Aisle Hand Rail

Requires no tool and stores on the deck in the bleacher's closed position. Rail rotates and snaps into place.



Self-Storing End Rails

This stylish self-storing rail is designed to meet the most stringent codes for rail loading and sphere passage. Add 12" (305 mm) to bank length for each railed end.

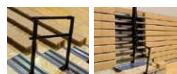

Powerglide™ Automatic Aisle Rails

Maximum safety with minimal effort. Open, the rail provides almost continuous support down the aisle. The rails automatically fold to the closed position as the bank closes.

Other Options



Safety End-Closure Curtains

Prevent unauthorized access to the underside of the bleacher, misuse that can result in injury, vandalism and potential liability risk. With Hussey Safety End-Closure Curtains, you can boost gym security while displaying your school pride. Built school-tough, they work beautifully and securely on new or existing bleachers. And Hussey offers the capability for full-bleed designs—including photographs. When paired with the CourtSide™ graphic logo, you can carry your school's identity throughout the gym.



CourtSide
Graphic Logo



Power Assist

Portable power permits one person to open and close manual sections by moving the tractor from section to section. Operates on standard 115 volt 20 amp service.



Integral Power

MAXAM®'s Powered Frame design applies force where needed—at the frames—and allows for better tracking over uneven floors. With five power options available, you buy only the power you need.



Elevated Front Aisle

Elevated front aisles start at various heights and run the length of the first row of the bleacher. EFA's improve sight lines and are ideal installations for hockey rinks and more. All can be outfitted with front rails, end rails, front panels or access stairs. An ideal solution to facilitate egress and accommodate your individual building requirements. Access stairs can be added as an option.



Aisle Steps

Intermediate steps at each vertical aisle are mounted to the deck providing code-compliant rises and tread depth. Steps are fitted with non-skid strips and offer rounded edges to enhance safety.



Motion Monitor

Audio-visual warning for an integrally powered unit that provides a flashing light with self-contained warning horn. Rated at 85 dB, it activates when bleachers are in motion.



Limit Switch

Limit switches ensure the motor stops once the bank is completely open or closed.



Hussey Seating Company™

The Hussey Seating Company story dates back to 1835 with William Hussey's tremendously successful plow design, and thus, the Hussey Plow Company was born. As times changed over the next sixty years, the family set about reinventing the business, evolving into the company that is now seating the world. Today, under the sixth generation of family leadership, Hussey Seating Company is proud to be known as the leading manufacturer of seating solutions throughout the world – in stadiums, arenas, schools, universities, colleges, places of worship and anywhere people gather.

Your partner for seating solutions.



husseyseating™

YOUR PARTNER FOR SEATING SOLUTIONS

38 Dyer Street Extension
North Berwick, Maine 03906 USA
Toll Free (USA) 1.800.341.0401
Tel: +1.207.676.2271
Fax: +1.207.676.2222
info@husseyseating.com
www.husseyseating.com

Regional Offices:
Europe & Middle East
Hussey Seatway
www.husseyseatway.com

Asia-Pacific
Hussey Asia-Pacific
www.husseyasiapacific.com

©2017 Hussey Seating Company. All rights reserved. Hussey Seating™, MAXAM®, MAXAM+™, Clarin®, Metro™, XtremeLogo™, Step-Signs™, CourtSigns™, CourtSides™, Flex-Row™, Posi-Lock™ and Powerglide™ are registered trademarks of Hussey Seating Company.

PERMA-CAP[®]

VINYL BLEACHER COVERS

BLEACHER COVERS

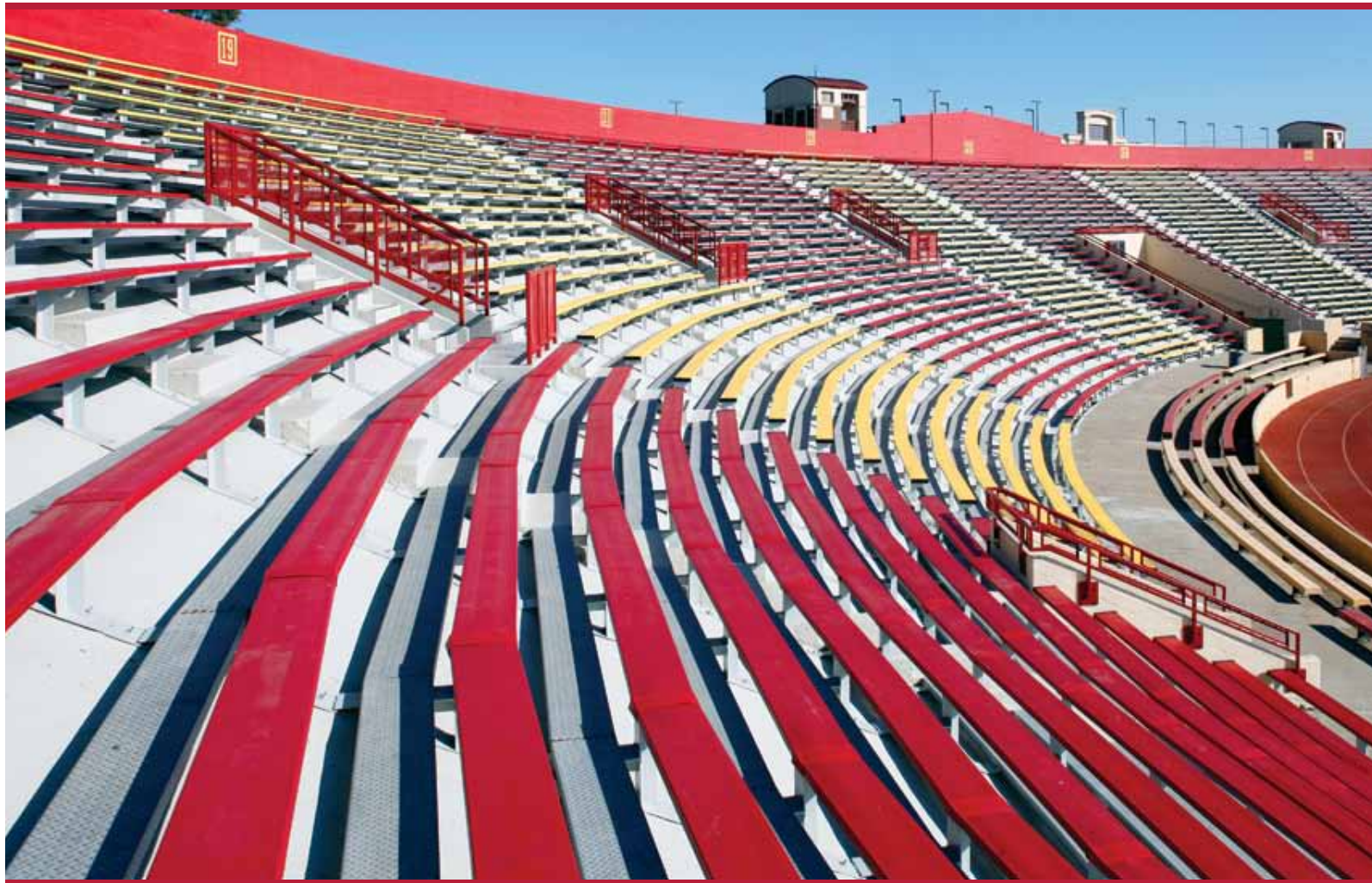

husseyseating[™]

YOUR PARTNER FOR SEATING SOLUTIONS

The Economical Bleacher Replacement

Perma-Cap® covers enhance and protect your bleacher investment, with installation and maintenance costs approximately half that of refinishing or replacing existing seating. In fact, Perma-Cap covers are a snap to install by your maintenance crew or an athletic boosters club.

Made from durable, UV stabilized vinyl, Perma-Cap covers maintain color fastness and impact properties over years of outdoor exposure, so pre-season maintenance is a breeze. And since Perma-Cap acts as an insulator, it won't draw heat from your body like aluminum will, making it an ideal way to add color and comfort to your existing aluminum grandstand.

Perma-Cap will rejuvenate your indoor gym bleachers as well. Perma-Cap eliminates the costly replacement and maintenance associated with lumber, and the vibrant colors will add a splash of school spirit as well!

For a complete plank replacement use Perma-Plank®, a sturdy galvanized steel plank covered with a durable layer of vinyl. The result is extra stable seating that can stand up to the worst weather, or glaring sunlight, for years on end without cracking or fading.



Perma-Cap
Hughes Stadium • Sacramento, CA
Lionakis Beaumont Design Group

INDOOR



- Standard lengths up to 20' (6096 mm)
- Available in 3/4" (19 mm) & 5/4" (32 mm) thicknesses
- Covers fixed and telescoping bleachers
- 14 standard colors

OUTDOOR



- Specially formulated acrylic polymers
- UV resistant/outdoor weatherable
- 2x8" (51 mm x 203 mm), 2x10" (51 mm x 254 mm) and 2x12" (51 mm x 305 mm) widths
- Standard lengths up to 18' (5486 mm)
- Environmentally friendly
- Non-reflective/splinter free
- 14 standard colors

PERMA-PLANK



PERMA-CAP over PERMA-PLANK

Galvanized Bleacher Planks
Galvanized steel is ideal for replacing old planks or for use in new construction.

- Roll formed galvanized steel
- Meets ASTM A-256
- 8" (203 mm), 10" (254 mm) & 12" (305 mm) widths
- Standard lengths up to 20' (6096 mm)

PERMA-CAP



PERMA-CAP over wood



PERMA-CAP over aluminum

End Caps



PERMA-CAP End Caps

- Available in black & grey

Standard Colors



*Actual colors and finishes may vary from printed color shown.

Sustainability

Hussey seating solutions come in a wide range of colors—but every day our seats get greener. If you'd like to learn more about our sustainability efforts, please visit our website at www.HusseySeating.com/sustainability

Resources

For more information on PERMA-CAP, visit www.HusseySeating.com

Warranty

5 year factory-backed warranty - the best in the industry.



PERMA-CAP[®]

VINYL BLEACHER COVERS



Hussey Seating Company[™]

The Hussey Seating Company story dates back to 1835 with William Hussey's tremendously successful plow design, and thus, the Hussey Plow Company was born. As times changed over the next sixty years, the family set about reinventing the business, evolving into the company that is now seating the world. Today, under the sixth generation of family leadership, Hussey Seating Company is proud to be known as the leading manufacturer of seating solutions throughout the world – in stadiums, arenas, schools, universities, colleges, places of worship and anywhere people gather.

Hussey. Your partner for seating solutions.

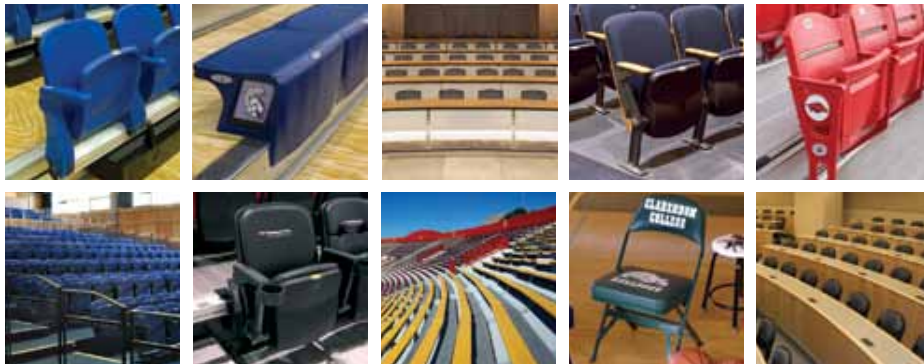

husseyseating[™]

YOUR PARTNER FOR SEATING SOLUTIONS

38 Dyer Street Extension
North Berwick, Maine 03906 USA
Toll Free (USA) 1.800.726.SEAT
Tel: +1.207.676.2271 • Fax: +1.207.676.2222
info@husseyseating.com • www.husseyseating.com



Sturdisteel PICNIC TABLES

*“Seating that lasts a lifetime –
and then some”*



5Year
Warranty

ORDER NOW
3 DAYS
SHIPPED FAST

MAD 
IN TEXAS ★ U.S.A
SINCE 1934

Ideal for all types of commercial and recreational areas, Sturdisteel picnic tables are engineered to withstand rigorous use, and provide years of maintenance-free service. These rugged picnic tables are the strongest, most durable offered anywhere, and are constructed of heavy-duty galvanized steel frames.

- ✓ *Outdoor common areas*
- ✓ *Sports facilities*
- ✓ *Parks and recreation*
- ✓ *Rest areas*
- ✓ *New or existing facilities*

Features:

- 2" square galvanized steel frame
- Aluminum or treated wood tops & seats
- Galvanized hardware
- 6' or 8' lengths
- Portable or surface mounted
- Handicap access tables available
- Custom lengths available

Dimensions

- 6-person table: 56" W x 72" L x 30" H
- 8-person table: 56" W x 96" L x 30" H



All steel and aluminum used by Sturdisteel is 100% recyclable. Zinc galvanized finishes on steel parts contribute positively to sustainable development initiatives because of its maintenance-free longevity, 100% recyclability, minimal environmental impact, and economic savings for future generations.

800.433.3116

P.O. Box 2655

Waco, TX 76702-2655

Sturdibleachers.com



clarín[®]
by husseyseating[™]

PORTABLE SEATING



husseyseating[™]
YOUR PARTNER FOR SEATING SOLUTIONS

OFTEN IMITATED - NEVER DUPLICATED

Providing aesthetic as well as practical appeal, the comfort and durability of Clarin portable chairs is legendary. They are engineered to provide decades of service and keep delivering outstanding value, day after day.

Winners have been sitting on Clarin portable chairs for years – from nearly all the NBA teams nationwide to local college athletes. We seat millions of spectators at event and concert venues every year, and thousands more of our friends and neighbors at town halls, schools, and churches.

Every Clarin comes with the full service, honesty and integrity that have been our hallmarks since 1928. Still made in the USA to this day, Clarin chairs continue to lead the industry – standing sentinel to our tradition of durability, quality, safety, and serving the customer.

PORTABLE SEATING

SOLUTIONS		APPLICATIONS	
Folding Chair Styles	4	Performing Arts	4
Premium Series	6	Awards	26
4000 Series	8	Sports & Entertainment	18
3050 Series	10	Casino	20
Stools	10	Convention Centers	22
2000 Series	12	Worship	24
		Dinner/Events	26
		Storage Cans	28
		Resources	28

UNRIVALED PERFORMANCE

For the highest quality portable folding chairs that will last year after year, look no further than Clarin by Hussey Seating™. For over 80 years, we've been perfecting our folding chair design to ensure it outperforms expectations. From economical all steel folding chairs to plush, luxurious upholstered folding chairs, there's a model to fit your facility's needs. And with options and upgrades like wider seats, tablet arms, cup holder arms, wood grain trim, custom logos and your choice of upholstery, it's easy to customize your chair for your exact needs.

Cover Photo
Clarin Premium Series | Models VIP and Contour w/ Printed Logo
Barclays Center • Brooklyn, NY

Clarin 3000 Series | Model 3400 w/ "K" Brace and Embroidered Logo
University of Minnesota Locker Room • Minneapolis, MN

FOLDING CHAIR STYLES

From plush foams and upholstery to simple, all steel designs, there's a folding chair to fit your seating wants and needs. If your goal is special seating sections for VIP guests where comfort and style are top priorities, the Premium Series will offer the luxury you're looking for. When high capacity row seating is on your mind, the 4000 Series with an uplift seat is just the ticket. And when you want logo seating for your team bench, you might look to the 3000 Series. No matter your portable seating need, we've got a folding chair model that fits the bill.



Clarín Premium Series | Model VIP w/ Embroidered Logo
Xavier University • New Orleans, LA



Premium Series
Designed for style and amazing comfort, the luxurious Premium Series models are the seats every spectator aspires to sit in.



4000 Series
With an uplift seat that provides wider seating rows when unoccupied, the 4000 Series is expertly engineered for facilities that require high capacity portable seating.



3000 Series
A classic folding chair model for any occasion, the 3000 Series is comfortable, durable and looks great with a custom logo.



2000 Series
A value model with unmatched durability, the 2000 Series is great for facilities on a tight budget that don't want to sacrifice quality.



Stools
A great option for locker rooms and any other place where you need a quick seat.

PREMIUM SERIES

Unrivaled portable seating comfort and distinctive designs give your players and premium patrons the seating experience they deserve. More and more venues choose Clarin Premium Series seating to create a memorable seating experience for their best customers. With an incredibly comfortable seat made of high density foam and ultraflex seat webbing, fans will want to keep coming back for more. Choose from the plush VIP, sleek Club and stylish Contour models.



Clarin Premium Series | Model VIP and Contour w/ Printed Logo
Barclays Center • Brooklyn, NY



VIP Series
Optional front & back leg covers
& arms



VIP Series



Club Series
Optional wood frame trim



Contour Series
Uplift seat

VIP – Featuring a fully upholstered back with our signature tuck design, the VIP is our most extravagant folding chair.

Club – Featuring a slimmer profile and distinctive back design, the Club is a stylish option for your premium seating areas.

Contour – Featuring Clarin's classic back design with a tuck and Premium Series ultraflex seat, the Contour offers advanced comfort with traditional style.

Custom Options – Add your unique style to the Premium Series with options like leg covers, slip covers, custom logos, permanent or detachable arms, wood grain or solid channel trim, custom upholstery, and many other options and accessories.

4000 SERIES

The 4000 Series Clarin chair has become the standard in portable seating among arenas and public assembly facilities worldwide. Featuring an automatic or manual uplift seat, the 4000 Series chairs are designed to maximize row traffic space and enhance patron safety. Standard on all 4000 Series chairs are oval marking decals on the seat bottoms for easy seat identification.



Clarin 4000 Series | Model 4400
Walmart Arkansas Music Pavilion • Rogers, AR



4000 Series
Uplift seat



4000 Series
Uplift seat



4000 Series
Contour seat



4000 Series
1 3/16" (38 mm) Interlocking Bracket

Uplift Seat - The distinguishing characteristic of the 4000 Series is an uplift seat that's designed for high capacity row seating. Choose from different padded seat depths, from 1" (25 mm) compact all the way up to comfortable 3" (76 mm) padded seats or a contour foam seat for ultimate comfort. No matter which seat you choose, you can rest assured knowing that these uplift chairs are built for high usage and will last for years to come.

Custom Options - Make the 4000 Series your own with options like automatic uplift seats, arm rests, erect pitch, ganging, Weather Fighter treatment, graphic customization, and much more.

3000 SERIES & STOOLS

A timeless classic that's widely used as portable spectator and athletic team seating, the 3000 Series folding chairs offer the performance and durability you expect, with a variety of comfortable padded seat and back options. A popular choice among athletic teams for team bench and locker room logo seating, the 3000 Series offers the perfect avenue for celebrating team spirit.

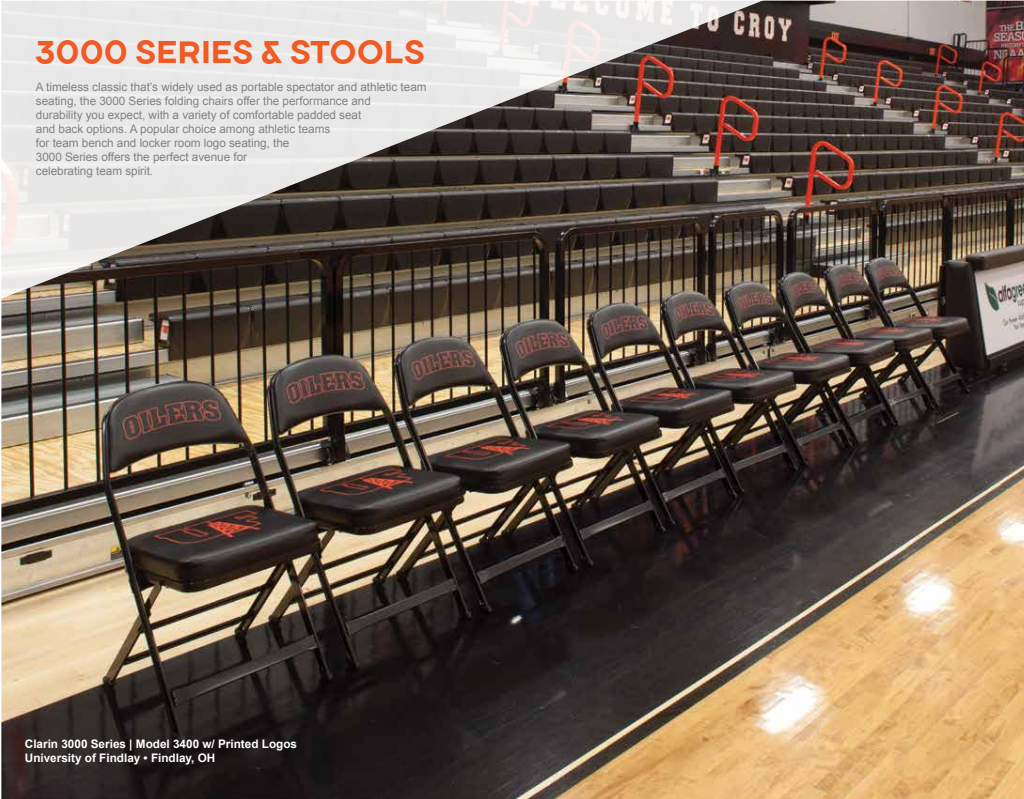

Clarín 3000 Series | Model 3400 w/ Printed Logos
University of Findlay • Findlay, OH



3000 Series
Seat and back logos



3000 Series
Double back logo



124
Medium stool



118
Short stool



130
Tall stool



185
Square stool

Classic Durability - Clarín's durable X-FRAME construction combined with your choice of padded or contour foam seats make the 3400 a winning choice for any facility. Add custom logos or designer upholstery to make it your own.

Countless Options - Customize your 3000 Series chair with options like a tablet arm, wide seat, tall seat, arms, heavy duty frame, custom logos, ganging and much more.

Custom Stools - Perfect for locker rooms, courtside, or any other space where you might need a quick seat. Circle top stools are available in 18" (457 mm), 24" (610 mm) and 30" (762 mm) heights, and the square stool provides a 3" thick rectangular seat pad at 18½" (470 mm) height.

2000 SERIES

A value line that doesn't skimp on durability, the 2000 Series portable folding chairs are perfect for facilities that host a variety of public and private gatherings. Designed for easy setup, takedown and storage 2000 Series folding chairs fold into a small envelope, perfect for facilities that need high capacity seating with limited storage.

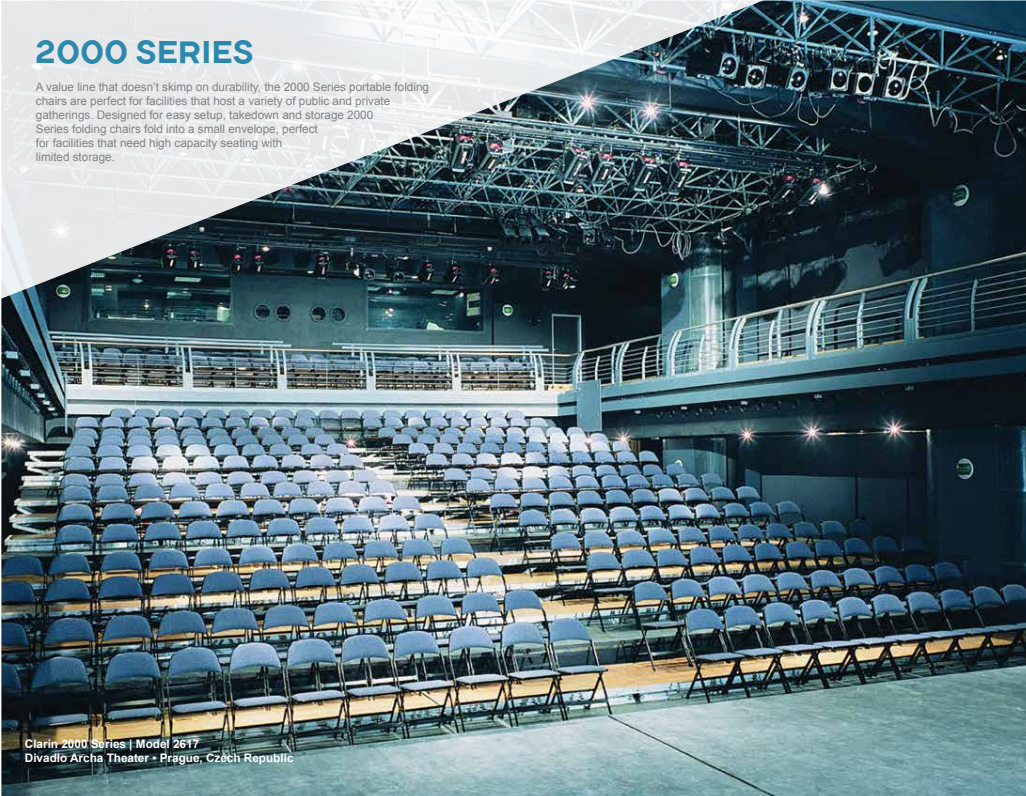

Clarín 2000 Series | Model 2617
Divadlo Archa Theater • Prague, Czech Republic



2000 Series
Upholstered seat & back



2000 Series
Contour steel seat & back



2000 Series
Upholstered seat & back
with tablet arm



2000 Series
Upholstered seat & back
with custom logo

Compact Value – Featuring our double tube and channel construction, X-FRAME design and your choice of finishes, the 2000 Series is a solid choice for occasional seating. Seat and back combinations include: all steel, fully padded, or a steel back with wood or padded seat. Folds to a 1¼ (48 mm) envelope. A youth version is also available.

Customize It – Make the 2000 Series your own with custom options like upholstery, tablet arm, custom logos and much more.

PERFORMING ARTS

Growing in popularity in the performing arts industry, Clarin's stylish and comfortable portable folding chairs give theaters the flexibility to host a variety of events that require different seating configurations. With options like cup holder arms and custom upholstery, our portable chairs won't disappoint even the most exclusive of guests.

Clarin Premium Series | Model VIP
Fallsview Theater • Niagara Falls, ON

Outdoor Amphitheater

Ready to Take on the Elements
Clarin's Weather Fighter treatment option provides added protection against the elements for venues that use Clarin chairs throughout the year in covered pavilions. Weather Fighter protects your seating investment with pre-coated frames, weather resistant seat and back boards, and marine-grade vinyl.

ARENAS

Large and small arenas alike benefit from the strength, durability and configuration freedom of our folding chairs. Choose one of our upright seat models to maximize row space and enhance patron safety. Built strong to withstand heavy use, yet light enough for easy setup and take down, you can rely on Clarin chairs year after year. With a wide array of chair styles, it's easy to create special seating sections that bring in more revenue, along with your standard seating sections.

Clarin Premium Series | Model VIP w/ Printed Logos
and 4000 Series | Model 4400 w/ Embroidered Logos
TD Garden, Boston, MA

Erect Pitch Option

Maximize Seating Capacity and Revenue
Maximize your seating capacity and revenue with the erect pitch option that reduces front-to-back spacing. Some facilities are able to add another row of seating, maximizing their ticket revenue. Available on 3000, 4000 and Contour series Clarin chairs.

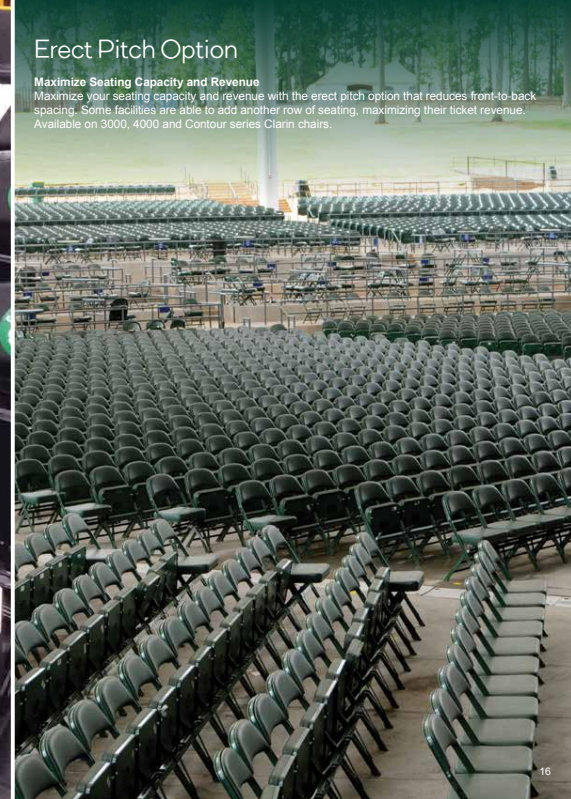

SPORTS & ENTERTAINMENT

As the leading supplier of portable seating in the sports and entertainment market, no one delivers higher quality folding chairs than Clarin by Hussey Seating. From custom, luxurious courtside chairs that seat some of the country's top athletes and celebrities to classic high school locker room chairs that seat tomorrow's pro athletes, we have a chair model for every budget.

Clarin 4000 Series | Model 4400
Madison Square Garden • New York, NY

Heavy Duty Titan Option

Strong Chairs for Strong Athletes
The Heavy-Duty Titan option provides additional frame strength and durability to Clarin 3000 series chairs in order to tolerate heavier loads, such as large athletes. The Titan's strength is achieved with additional metal support components to the chair frame, including extra stretchers, X-FRAME reinforcements and a modified seat frame. Choose a wider and/or taller frame to make your athletes even more comfortable.

CASINOS

Known to host many different types of events, Casino venues are adding Clarin portable chairs to their seating mix to maximize their configuration freedom. With our premium chair styles and plush seating options, casino guests that are used to being pampered won't miss a step.

Clarin 4000 Series | Models 4400 and 4010
First Council Casino • Newkirk, OK

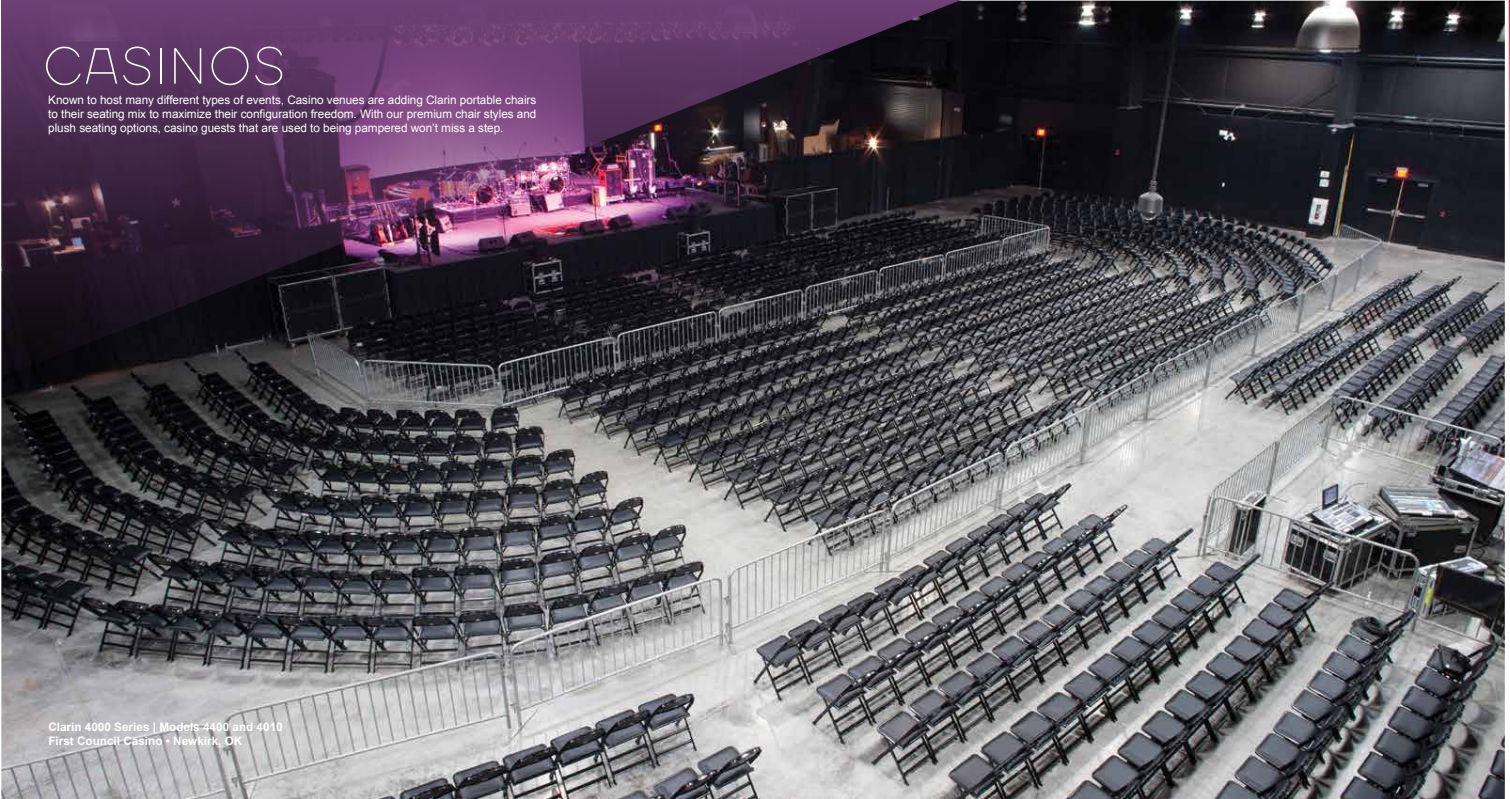

Chair Ganging Options

Uniformity Begins with Ganging
Choose one of our durable ganging options to maintain a uniform look during events. There's a ganging option for every type of folding chair, including: 1/8" (3 mm) brackets for no-arm chairs (shown below), 3/2" (13 mm) brackets for added personal space, 1" (25 mm) for one-arm chairs (shown below), 1 3/8" (38 mm) ganging on any model for more personal space, under-arm ganging for two-arm chairs, radius ganging for round spaces and removable ganging bracket



CONVENTION CENTERS

Convention Centers can choose from a wide selection of Clarin folding chairs to fit their ever-adapting needs. Our attractive fabrics and versatile designs will seamlessly match any décor. Plus, our chairs gang easily, store efficiently and are easy to setup, take down and store with the use of our portable storage systems.



Clarin 4000 Series | Model 4400
Dallas Convention Center • Dallas, TX

Multi-Use Seating

Seating for Any Event
From high capacity row seating to scattered banquet seating, Clarin folding chairs are versatile enough to handle any type of event.

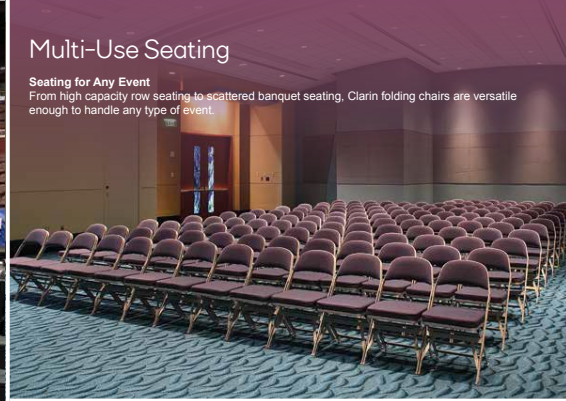

Storage Carts

Seating for Any Event
From high capacity row seating to scattered banquet seating, Clarin folding chairs are versatile enough to handle any type of event.

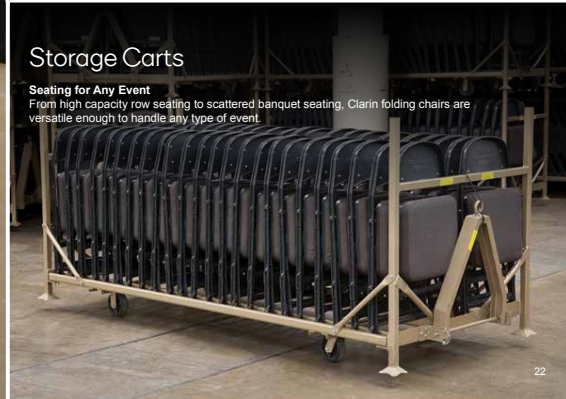

WORSHIP

A great alternative to pews, Clarin portable folding chairs offer places of worship a diverse product offering for multi-use flexibility. Our legendary frame and multiple storage cart options provide maximum durability and portability, while the comfortable cushion seats and stylish fabric options provide you an upscale look and plush feel.

Clarin 2000 Series | Model 2617
Westminster Abbey • London, UK

Amazing Comfort

Our popular model 3400 with a contour foam and ultraflex suspension seat for exceptional guest comfort. We also offer an expansive breadth of tested and approved upholstery fabrics to consider, from basic to extreme luxury.

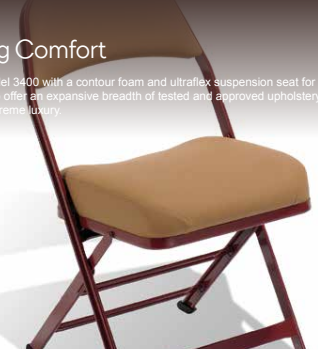

Youth Folding Chair

Clarin's youth folding chair is made just for kids. The smaller design fits youngsters perfectly and takes up less space than standard chairs, a great option for places of worship or schools.



Dimensional Data

The chair and storage cart dimensional data shown is for our standard models. For a full list of models, visit www.clarinseating.com.

Premium Series VIP

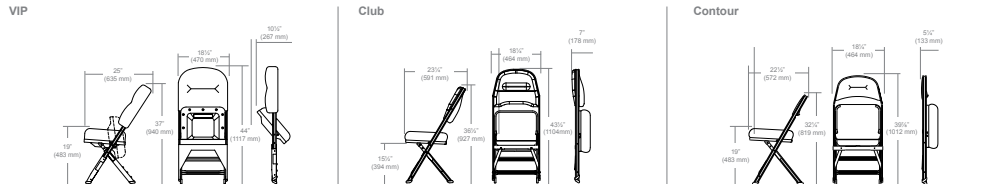

4000 Series 4010

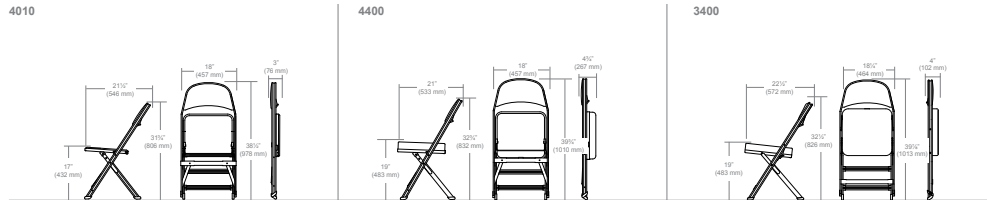

2000 Series 2617

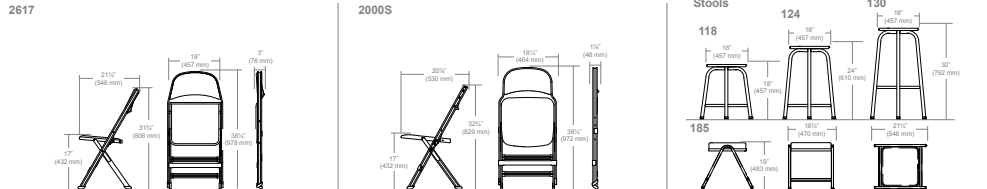

2000S

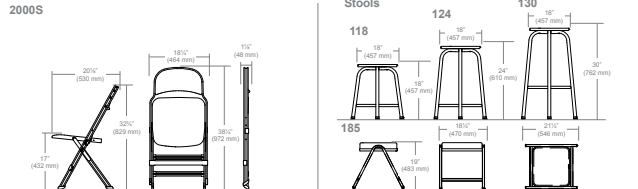

Stools

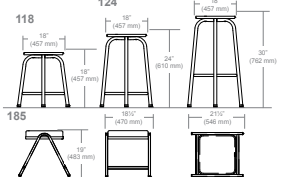

Storage Carts

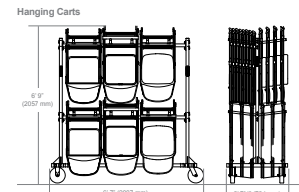
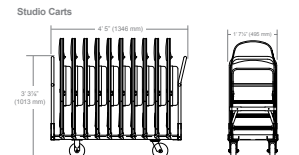
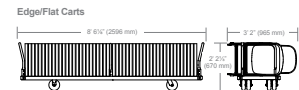
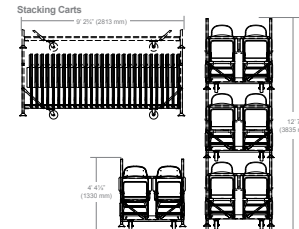

Sustainability

At Hussey Seating, respecting the landscape we live in—and the hard work and well-being of the people we work with—has always been in our DNA and part of our heritage. Our commitment to environmentally friendly business practices has taken many forms over the years as standards and technology have changed.

In the 1970s, when the rest of the nation began to become more environmentally aware, we had already laid walking trails and planted a tree farm on our beautiful Maine campus. Today, going green means developing environmentally friendly paints and finishes, sourcing sustainable woods and metals, going beyond local and national regulations in clean manufacturing and waste disposal, and making deliveries on time while reducing our carbon footprint. We reduced our air emissions by 90% while tripling our seating business, so we know green business is good business.

Hussey seating solutions come in a wide range of colors—but every day our seats get greener. If you'd like to learn more about our sustainability efforts, please visit our website at www.husseyseating.com/sustainability



Resources

For all Clarin® accessories, surface materials, fast facts, environmental data sheets and more go to HusseySeating.com.

News & Updates

Web: HusseySeating.com
 Facebook: facebook.com/HusseySeating
 Twitter: twitter.com/husseyseating
 YouTube: youtube.com/user/hspublic
 LinkedIn: linkedin.com/company/hussey-seating-company

Warranty

Our factory-backed warranty is the best in the industry.

Interior Warranty
 Limited Lifetime: structure
 5 years: components

Exterior Warranty
 Limited Lifetime: structure
 5 years: components

3 years: foam, powder coat finish
 1 year: upholstery stitching and thread, polymer finish

Expert Support

It's standard equipment on every Hussey product.

- Safety Inspections
- Service Contracts
- Accessories
- Custom Fabrication
- Factory-Certified Parts
- Renovation & Repair

Toll-Free (USA) 1.800.353.3308



clarin[®]
by **husseyseating**[™]

Hussey Seating Company[™]

The Hussey Seating Company story dates back to 1835 with William Hussey's tremendously successful plow design, and thus, the Hussey Plow Company was born. As times changed over the next sixty years, the family set about reinventing the business, evolving into the company that is now seating the world. Today, under the sixth generation of family leadership, Hussey Seating Company is proud to be known as the leading manufacturer of seating solutions throughout the world – in stadiums, arenas, schools, universities, colleges, places of worship and anywhere people gather.

Your partner for seating solutions.

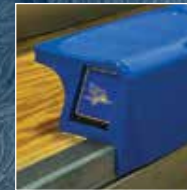

husseyseating[™]

YOUR PARTNER FOR SEATING SOLUTIONS

38 Dyer Street Extension
North Berwick, Maine 03906 USA
Toll Free (USA) 1.800.341.0401
Tel: +1.207.676.2271
Fax: +1.207.676.2222
info@husseyseating.com
www.husseyseating.com

Regional Offices:

Europe & Middle East
Hussey Seatway
www.husseyseatway.com

Asia-Pacific
Hussey Asia-Pacific
www.husseyasiapacific.com



Panther Stadium - Van Alstyne

PRESS BOXES for Stadiums

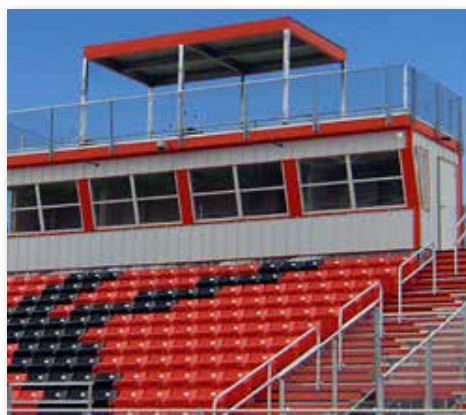

Yellow Jacket Stadium - Kemp, TX

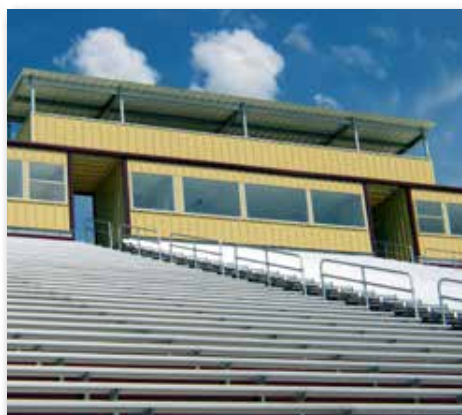

Bulldog Stadium - Magnolia, TX



Buccaneer Stadium - Winnie, TX

Press Boxes are an integral part of a grandstand that not only provide seating for coaches, press and announcers, but also enhance the aesthetic look of any venue. As a custom manufacturer, we design press boxes that meet your specific needs for both form and function.

Using modern construction methods and modular designs, we create an aesthetically pleasing press box that will hold up under the heaviest usage. Our cost-effective press box structures comply with all state inspection requirements and are constructed with the quality of conventional metal buildings.

Features:

- Exterior 26 gauge type R metal panels
- Non-combustible steel framing
- 5/8" CD Exterior Grade plywood
- Inside wall 3/8" regular sheetrock
- Pre-wired for local power connection
- 2' x 2' x 58" acoustical tile

Options:

- Filming Deck
- Air conditioning
- Security shutters
- Sloped front
- Roof hatch
- Multiple rooms
- Fixed glass



Sturdisteel is a Division of Schultz Industries, Inc.

P.O. Box 2655, Waco, TX 76702-2655

TEL: 254.666.5155

FAX: 254.666.4472

TOLL FREE: 800.433.3116



www.Sturdisteel.com



Quattro®
different. by design.

THEATER & AUDITORIUM SEATING



husseyseating™

YOUR PARTNER FOR SEATING SOLUTIONS

BRINGING YOUR VISION TO LIFE

Every audience space is different – from performing arts centers to auditoriums to sports & entertainment venues. And we understand that your seating solution needs to complement and enhance the design vision for that space.

Hussey Seating has a long tradition of providing high quality seats designed to be an integral part of an audience space. We also know that the key to developing and providing the perfect seating solution is an understanding of each customer's unique needs.

That collaboration is the key to our success, and we look forward to working with you to create the perfect audience seating solution for your space.

THE QUATTRO® COLLECTIONS

SOLUTIONS	APPLICATIONS
Seat Styles 3	Performing Arts 13
Designer Series 5	Education 15
Classic Series 7	Sports & Entertainment 17
Soft Side Series 9	Casinos 19
Performance Series 11	Multi-Use Flexibility 21
	Worship 23
	Dimensions & Resources 25

Cover Photo
Quattro Collection with Designer Series Chair
SFSC Theatre for the Performing Arts • Avon Park, FL
Leo A. Daly Architects

Quattro Collection with Classic Series Chair
Plainfield High School • Plainfield, IN
Schmidt Associates

SUPERIOR DESIGN

Create an extraordinary spectator seating experience with Quattro® fixed seating by Hussey Seating Company. Beautiful sculptural lines, state-of-the-art materials, ergonomic comfort and unprecedented flexibility are just a few of the features that set Quattro apart from the rest.

Choose from the contemporary **Quattro Collection** or the classic **Quattro Traditional Collection**, each offering our four sleek, modular seat series – Designer, Classic, Soft Side and Performance. No matter which you choose, every Quattro seat is backed by the Hussey Seating limited lifetime warranty – the best in the business.



Quattro Collection
From top to bottom, every aspect of the Quattro Collection has been designed to balance form and function in beautiful new ways. While you may opt for available end panels, Quattro Collection's stanchions are designed to be so captivating, they can stand all on their own.

Quattro Traditional Collection
A perfect blend of old and new, the Quattro Traditional Collection has a traditional stanchion and end panel, providing an elegant solution for those who prefer a more classic look. It's also a perfect solution when retrofitting to match an existing décor.

Whatever your auditorium layout, Quattro seats provide the design and dimensions you need to make a seating layout that works. Contact your local Hussey Seating expert today to start creating your custom Quattro seating layout.

THE QUATTRO® STORY STARTS AT THE BACK

The modular Quattro Collections are built on four superb seat styles, each featuring a chair back created for a distinct aesthetic and practical effect. With more choices for more applications, the Quattro Collections are built from the ground up to be different. By design.

Quattro Collection with Classic Series Chair
Fayetteville State University • Fayetteville, NC
Pearce Brinkley Coase + Lee



Designer Series
The elegant upholstered Designer Series, complete with finished outer back, makes an impressive statement. Choose from a broad selection of wood veneers and quality laminates for a stunning look.



Classic Series
Timeless style, great looks and a durable polymer outer panel. The hard-working Classic Series offers all this and your choice of upholstery and tailoring options. A true multi-purpose classic.



Soft Side Series
Audiences will appreciate the plush comfort, beautiful styling and excellent acoustic qualities of the Soft Side's luxurious, fully-enveloped upholstered design.



Performance Series
Designed for high-use environments, the Performance Series is virtually maintenance free, yet still upholds Quattro's high standards for comfort, style and long-lasting performance.

DESIGNER SERIES

As elegant as it is functional, the Designer Series seat style combines rich wood or laminate tones and plush upholstered seats to offer the ultimate in fixed spectator seating. A simple, yet stunningly smooth back design creates an amazing visual effect from the back of the venue, while the luxurious upholstery and quilting options demand attention from the front. Not only will your events "wow" the crowd, so will your Designer Series seating.

Quattro® Collection with Designer Series Chair
McCoy Center for the Arts • Albany, OH
Westlake, Reed & Leskowsky

High Style – The beautifully finished outer back and clean European lines of the Designer Series seat give your venue an exquisite look. Ideal for suites, corporate settings, performing arts theaters or places of worship, the Designer Series is sure to impress.

Furniture Quality – With unlimited stain options on nine rich wood veneers, over 200 distinctive laminates, and fabrics from basic to extreme luxury, your seats will have an amazing furniture-quality finish.

Countless Options – Customize your Designer Series seats with a wide array of back shapes, seat options, arm rests, tablet arms, cast aluminum or steel stanchions, aisle lights, seat ID and much more. Make it your own.



A



B



C



D

A. Quattro Designer
Soft square, high back with cast aluminum standards, two tone color accents and T2 tablet. Shown with custom quilting.

B. Quattro Designer
Soft square, high back with cast aluminum standards, two tone color accents and T1 tablet. Shown with custom quilting.

C. Quattro Traditional Designer
Soft square, high back with wood veneer outer back and matching swept style end panel and traditional style armrest.

D. Quattro Designer
Soft square, high back with wood veneer outer panel with cherry stain and matching hardwood armrest.

CLASSIC SERIES

Timeless style, great looks and a durable polymer outer panel make the Classic Series seat a great choice for any venue. It's a true multi-purpose classic that's comfortable, durable and attractive. Dress it up with one of our many luxury upholstery, handsome quilting designs, and chic stanchion color combinations.



Quattro® Collection with Classic Series Chair w/ Tablet Arms
Hillside Auditorium - University of Arkansas • Fayetteville, AR
Partners Architects



Stylish and Durable – The Quattro® Classic Series seat combines the clean lines and contemporary style of a fine upholstered chair with a highly durable molded polymer back for easy maintenance and long-term piece of mind.

A Proven Classic – Handsome, comfortable and always reliable, this versatile chair is equally at home in schools, sporting and multi-purpose facilities.

Limitless Combinations – Customize your Classic Series chair with a wide choice of Quattro options to build a chair that's your own.



A. Quattro Classic
Round, low back with cast aluminum standards, hardwood armrests and one of our standard quilting offerings.



B. Quattro Classic
Soft square, low back with steel standards, cupholder armrest and one of our standard quilting offerings.



C. Quattro Traditional Classic
Round, low back with traditional steel standards with matching swept style end panel and traditional style armrest.

D. Quattro Classic
Round, low back with cast aluminum standards, polymer armrests and one of our standard quilting offerings.

SOFT SIDE SERIES

Make a statement without making a sound with the Soft Side Series seat. Envelop spectators in fully upholstered comfort, absorbing audience noise while seating guests in style. Precision, elegance and luxury are the hallmarks of these fixed auditorium seats, ideal for lecture hall and performing arts seating.



Quattro® Collection with Designer Series Chair
Circus Maximus Theater • Atlantic City, NJ
Nickerson Corporation



Fully Upholstered — Wrapped in the lush fabric of your choice, with optional fully-enveloped seat pan, the Quattro® Soft Side Series seat embodies luxurious style. Add upholstered end panels for a completely draped look.

Acoustic Performance — More than just attractive, the Soft Side effectively minimizes audience noise and enhances sound absorption qualities, making it a handsome choice for performing arts venues, cinemas, houses of worship, corporate settings or wherever sound and vision come together.

Custom Options — Add your unique signature to the Soft Side with touches like a high back, aisle lights, logo embroidery, custom woven fabrics, or any of our other options and accessories.

A. Quattro Soft Side
Soft square, high back with custom embroidered back and fully enveloped seat. Accented with hardwood armrests and upholstered end panels.

B. Quattro Traditional Soft Side
Soft square, high back with fully enveloped end panel and armrests.

C. Quattro Soft Side
Soft square, low back with cast aluminum standards and cupholder armrest.

D. Quattro Soft Side
Soft square, low back with cast aluminum standards, polymer armrests and T2M tablet.

PERFORMANCE SERIES

Discover seating as versatile as it is durable, attractive and safe. Sports arenas, entertainment venues, or educational facilities - the Quattro® Performance Series is comfortable in any setting. This affordable seating is designed for performance with an eye for beauty and style. And because Quattro Performance Series seats are interchangeable with other Quattro products, they're easy to upgrade or mix and match. You can easily create tiered seating that goes from polymer to plush, while maintaining a singular aesthetic style.

Quattro Traditional Collection with Plyform Chair
Carver Center For Arts & Technology • Towson, Maryland
Grimm + Parker

Performance Series - Plyform

Blending classic plywood design with advanced Hussey performance and safety, the Quattro® Performance Series Plyform stands up to the rigors of your school environment. The seats and backs are made from 11-ply cross-banded plywood. Flat-sided traditional oval steel stanchions add strength as well as style. Plus, our signature seat back design extends below the seat to keep toes from getting pinched.

A. Quattro Traditional Performance - Plyform
Soft square, contoured low back with matching plyform seat, end panels and armrests. Traditional steel standards.

Performance Series Plyform is only available with a Quattro Traditional style standard.



B. Quattro Performance - Polymer
Soft square, contoured low back with matching polymer seat. Shown with optional end panel and TR1 tablet. Traditional steel standards.



C. Quattro Performance - Polymer
Jungle back and cast aluminum standards.

D. Quattro Performance - Polymer
Crescent back and cast aluminum standards.

Performance Series - Polymer

Quattro Performance Series Polymer seats are fashioned in school-proof polymer with style that adds a touch of class to auditoriums. Each part is easy to replace, and the seats are easy to upgrade with shared Quattro components.

All Performance Series chairs are available with optional tablet arm, including our new TR-1 Tablet when equipped with our Traditional steel stanchion. The TR-1's large (110 Sq.in.) tablet stows completely within the chair space, and yet provides more seating space for the user when in use than traditional tablets. Its panic proof operation features a controlled return mechanism to ensure smooth, quiet operation.

Customize your Performance Series Polymer seats with a plain, jungle or crescent style back. Available with cast aluminum, steel or traditional steel stanchions.

PERFORMING ARTS

In a perfect union of aesthetics, functionality and comfort, Quattro® is the perfect seating solution for performing arts venues. Designed to match the stunning architectural accents of your facility, Quattro seats are just as much a part of the show as the act is. Plus, with Quattro's whisper quiet seats you won't have to worry about distracting noise as patrons shuffle in and out of their seats.

Quattro Collection with Designer Series Chair
East High School - Wichita, KS
Kansas Contract Design

Nostalgia End Standard Option

Creating the Look of Yesteryear
The Quattro® Nostalgia end standard option provides design lines of the golden live performance era. The decorative cast steel end standard can be customized with a logo or design to meet your architectural requirements. The scrolled wood armrest provides a fine finish detail to enhance the overall look of days gone by.

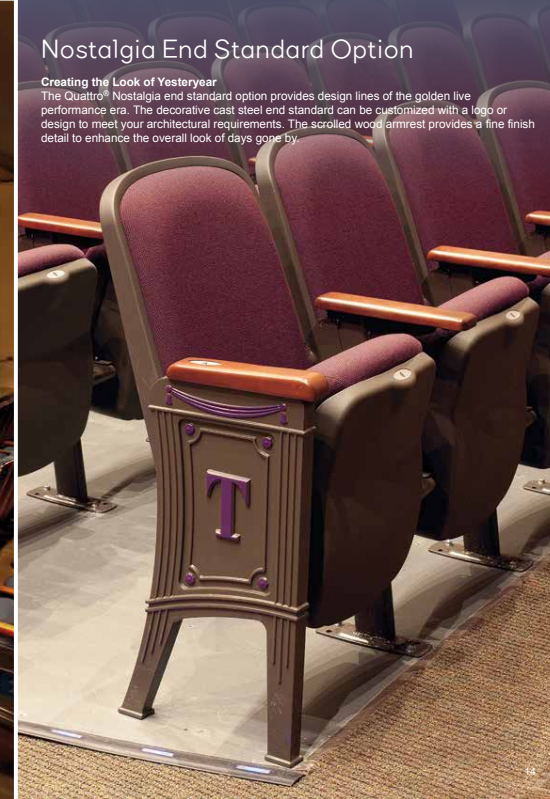

EDUCATION

Whether your goal is a luxurious lecture hall or a smaller, more affordable classroom, Quattro has a fixed seating solution that fits the bill. For a formal lecture hall, choose the Quattro Designer Series or Classic Series, and for a less expensive option choose one of the Performance Series seats. No matter which seat you choose, you'll be happy with the durability, style and comfort.

Quattro® Collection with Classic Series Chair w/ Tablet Arms
Hillside Auditorium - University of Arkansas • Fayetteville, AR
Partners Architects

Stacking Quattro™

Flexible ADA Capacity On-Demand

Our new Stacking Quattro combines the convenience and flexibility of traditional portable stacking chairs with the style and comfort you expect in an upholstered auditorium chair. The Stacking Quattro maintains your room's aesthetic while providing the ability to accommodate ever-changing demand for ADA and companion seating capacity. Stacks four high on our optional transport cart for easy storage.



SPORTS & ENTERTAINMENT

From lavish suites to VIP sideline seating, arenas never looked so good, and your patrons have never been more comfortable. The Quattro® Collection has solutions for your entire arena project, solutions you can specify with confidence.

Quattro Collection with Classic Forward Fold Chair
Danny Sanford Premier Center • Sioux Falls, SD
Sink Combs Dethlefs, Koch Hazard

Stacking Quattro™

Gives new meaning to "The best seat in the house"

Combining the style and comfort of our Quattro Auditorium chair with the flexibility of a portable stacking chair, the Stacking Quattro ensures that a purchasing premium seat space means enjoying a premium spectator experience. Designed for easy ganging and available with optional cupholder arms. Available with our 30-chair storage/transport cart.

Quattro Extreme™

Ready to Take on the Elements

Quattro Extreme combines the luxury of an upholstered indoor chair with the durability of an outdoor stadium seat for your open-air seating. Rugged and weather-resistant, Quattro Extreme has rust-proof stanchions, corrosion-resistant hardware, and marine-grade fabric to protect your seats while offering spectators the most comfortable outdoor seating experience.

CASINOS

Casino guests that are used to a certain level of luxury won't be disappointed when they lean back in a plush Quattro® Collection chair to enjoy a show. Light the way to their seats with stylish aisle lights integrated into the chair frame. The Designer Series or Classic Series seats have all the features you need to dazzle your audience, including convenient front or rear mount cup holders.

Quattro Collection with Designer Series Chair
Harrah's Casino • Atlantic City, NJ
BLT Architects

Integrated LED Aisle Lights

Lighting the Way

Help your guests locate their seat row with integrated Quattro® LED Aisle Lights. Each aisle light powers three low-volt (24v) LEDs that are seamlessly oriented in your choice of the armrest (high mount – shown below) or axis point (low mount). Both are U.L. Listed.

MULTI-USE FLEXIBILITY

Give your gymnasium, auditorium or cafeteria the flexibility to adapt to evolving space-use demands. Since demographic shifts usually outpace building budgets, adaptability is a critical element of school design. And nobody has more experience and expertise delivering seating solutions that maximize your school's space-use flexibility than your Hussey Seating Company dealer.

Quattro® Collection with Classic Series Chair
Grand Prairie Center • Stuttgart, AR
SCM Architects

Telescopic Seating

One Facility. Unlimited Flexibility.
Adding Telescopic Seating to your facility gives you extra space that can be used for practice areas, batting cages, volleyball, gymnastics or any wide array of uses. No one offers a broader range of features, accessories, and engineering options to meet your telescopic seating needs than Hussey Seating.



WORSHIP

Casino guests that are used to a certain level of luxury won't be disappointed when they lean back in a plush Quattro® Collection chair to enjoy a show. Light the way to their seats with stylish aisle lights integrated into the chair frame. The Designer Series or Classic Series seats have all the features you need to dazzle your audience, including convenient front or rear mount cup holders.

Quattro Collection with Classic Series Chair
Champions Center • Tacoma WA
Nor-Pac Seating

Facility Renovations

Modern Comfort for Traditional Architecture

A great option for worship facility seating renovations, Quattro® transforms dated pews into sleek, ergonomic and inviting fixed congregation seating. Choose from stylish seat-curling options and soft upholstery to create a comfortable and welcoming environment.



Seating Layout

Row Spacing (all Quattro® series)

To help facilitate your design solution, calculate seating row lengths and row spacing by using the example below. Pick your chair series and width from the appropriate dimensional data, multiply by the number of chairs in the row and add A for each end.

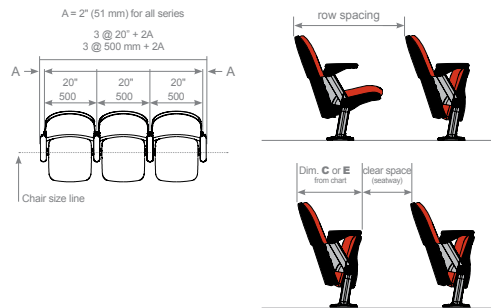

Seat Width Dimensional Data

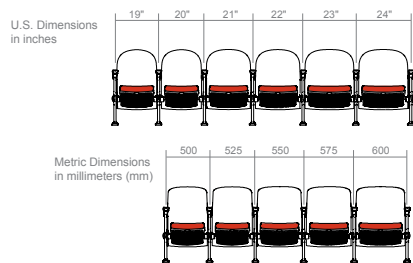

Dimensional Data

Quattro Collection: Designer, Soft Side and Classic Series

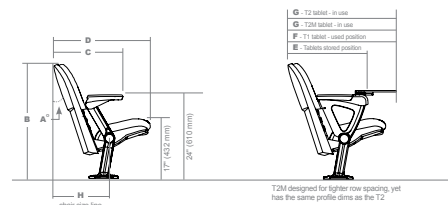

	A*	B	C	D	E	F	G	H
21"	33"	628 mm	19.78"	505 mm	27.78"	709 mm	30.78"	784 mm
19"	33.34"	630 mm	19.94"	478 mm	28.34"	680 mm	31.59"	549 mm
18"	34.12"	676 mm	17.58"	448 mm	25.58"	651 mm	28.58"	727 mm
21"	38"	645 mm	21"	534 mm	23.78"	697 mm	30"	813 mm
19"	38.34"	654 mm	19.34"	522 mm	27.34"	702 mm	30.34"	781 mm
17"	37.12"	653 mm	18.12"	470 mm	26.12"	675 mm	21.38"	543 mm
15"	37.12"	653 mm	18.12"	470 mm	26.12"	675 mm	30.14"	788 mm

Maximum rise 24" (610 mm) | Minimum rise 6" (152 mm)

Quattro Collection: Performance Series

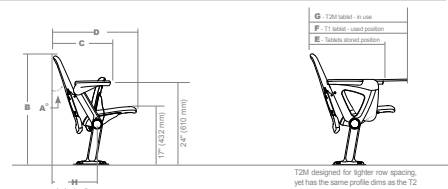

	A*	B	C	D	E	F	G	H
21"	31.12"	650 mm	18.12"	449 mm	23.78"	694 mm	30.78"	784 mm
19"	32.58"	629 mm	N/A	N/A	N/A	N/A	17.54"	438 mm
15"	32.58"	629 mm	N/A	N/A	N/A	N/A	10.12"	267 mm

Maximum rise 24" (610 mm) | Minimum rise 6" (152 mm)

Quattro Traditional Collection: Designer, Soft Side and Classic Series

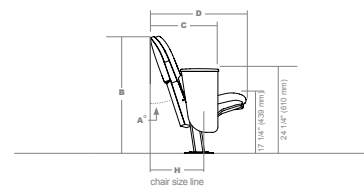

	A*	B	C	D	E	F	G	H
21"	33.12"	651 mm	19.78"	509 mm	27.78"	709 mm	30"	802 mm
19"	34.12"	676 mm	17.58"	448 mm	25.58"	651 mm	33.34"	849 mm
18"	35"	689 mm	18.12"	419 mm	24.12"	620 mm	32.58"	819 mm
21"	38"	676 mm	21"	534 mm	23.78"	697 mm	30"	813 mm
19"	38.34"	684 mm	19.34"	522 mm	27.34"	702 mm	30.34"	781 mm
17"	37.12"	653 mm	18.12"	470 mm	26.12"	675 mm	21.38"	543 mm
15"	37.12"	653 mm	18.12"	470 mm	26.12"	675 mm	30.14"	788 mm

Maximum rise 24" (610 mm) | Minimum rise 6" (152 mm)

Quattro Traditional Collection: Performance Series

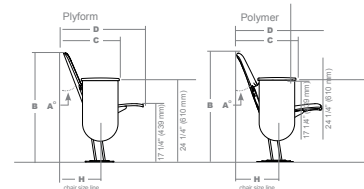

	A*	B	C	D	E	F	G	H
21"	31.12"	650 mm	18.12"	443 mm	23.18"	679 mm	31.78"	802 mm
19"	31.12"	650 mm	18.12"	443 mm	23.18"	679 mm	11.78"	302 mm
15"	31.12"	650 mm	18.12"	443 mm	23.18"	679 mm	11.12"	279 mm
12"	32.12"	628 mm	13.58"	346 mm	20.12"	629 mm	2.14"	238 mm

Plyform

	A*	B	C	D	E	F	G	H
21"	31.12"	650 mm	17.54"	438 mm	24.12"	629 mm	32.78"	827 mm
19"	31.12"	650 mm	17.54"	438 mm	24.12"	629 mm	12.12"	318 mm
15"	32.58"	629 mm	14.58"	397 mm	22.58"	581 mm	11.12"	286 mm
12"	32.58"	629 mm	14.58"	397 mm	22.58"	581 mm	10.38"	264 mm

Maximum rise 24" (610 mm) | Minimum rise 6" (152 mm)



Sustainability

At Hussey Seating, respecting the landscape we live in—and the hard work and well-being of the people we work with—has always been in our DNA and part of our heritage. Our commitment to environmentally friendly business practices has taken many forms over the years as standards and technology have changed.

In the 1970s, when the rest of the nation began to become more environmentally aware, we had already laid walking trails and planted a tree farm on our beautiful Maine campus. Today, going green means developing environmentally friendly paints and finishes, sourcing sustainable woods and metals, going beyond local and national regulations in clean manufacturing and waste disposal, and making deliveries on time while reducing our carbon footprint. We reduced our air emissions by 90% while tripling our seating business, so we know green business is good business.

Hussey seating solutions come in a wide range of colors—but every day our seats get greener. If you'd like to learn more about our sustainability efforts, please visit our website at www.husseyseating.com/sustainability



Resources

For all of Quattro®'s accessories, surface materials, fast facts, environmental data sheets and more go to HusseySeating.com.

News & Updates

Web: HusseySeating.com
 Facebook: facebook.com/HusseySeating
 Twitter: twitter.com/husseyseating
 YouTube: youtube.com/user/hscpublic
 LinkedIn: linkedin.com/company/hussey-seating-company

Warranty

Our factory-backed warranty is the best in the industry.

Interior Warranty
 Limited Lifetime: structure
 5 years: components

Exterior Warranty
 Limited Lifetime: structure
 5 years: components

3 years: foam, powder coat finish
 1 year: upholstery stitching and thread, polymer finish

Expert Support

It's standard equipment on every Hussey product.

- Safety Inspections
- Service Contracts
- Accessories
- Custom Fabrication
- Factory-Certified Parts
- Renovation & Repair

Toll-Free (USA) 1.800.353.3308



Quattro[®]
different. by design.

Hussey Seating Company[™]

The Hussey Seating Company story dates back to 1835 with William Hussey's tremendously successful plow design, and thus, the Hussey Plow Company was born. As times changed over the next sixty years, the family set about reinventing the business, evolving into the company that is now seating the world. Today, under the sixth generation of family leadership, Hussey Seating Company is proud to be known as the leading manufacturer of seating solutions throughout the world – in stadiums, arenas, schools, universities, colleges, places of worship and anywhere people gather.

Your partner for seating solutions.

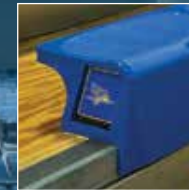

husseyseating[™]

YOUR PARTNER FOR SEATING SOLUTIONS

38 Dyer Street Extension
North Berwick, Maine 03906 USA
Toll Free (USA) 1.800.341.0401
Tel: +1.207.676.2271
Fax: +1.207.676.2222
info@husseyseating.com
www.husseyseating.com

Regional Offices:

Europe & Middle East
Hussey Seatway
www.husseyseatway.com

Asia-Pacific
Hussey Asia-Pacific
www.husseyasiapacific.com

Legend™

fusion™

Quattro™
EXTREME

SPORTS & ENTERTAINMENT SEATING

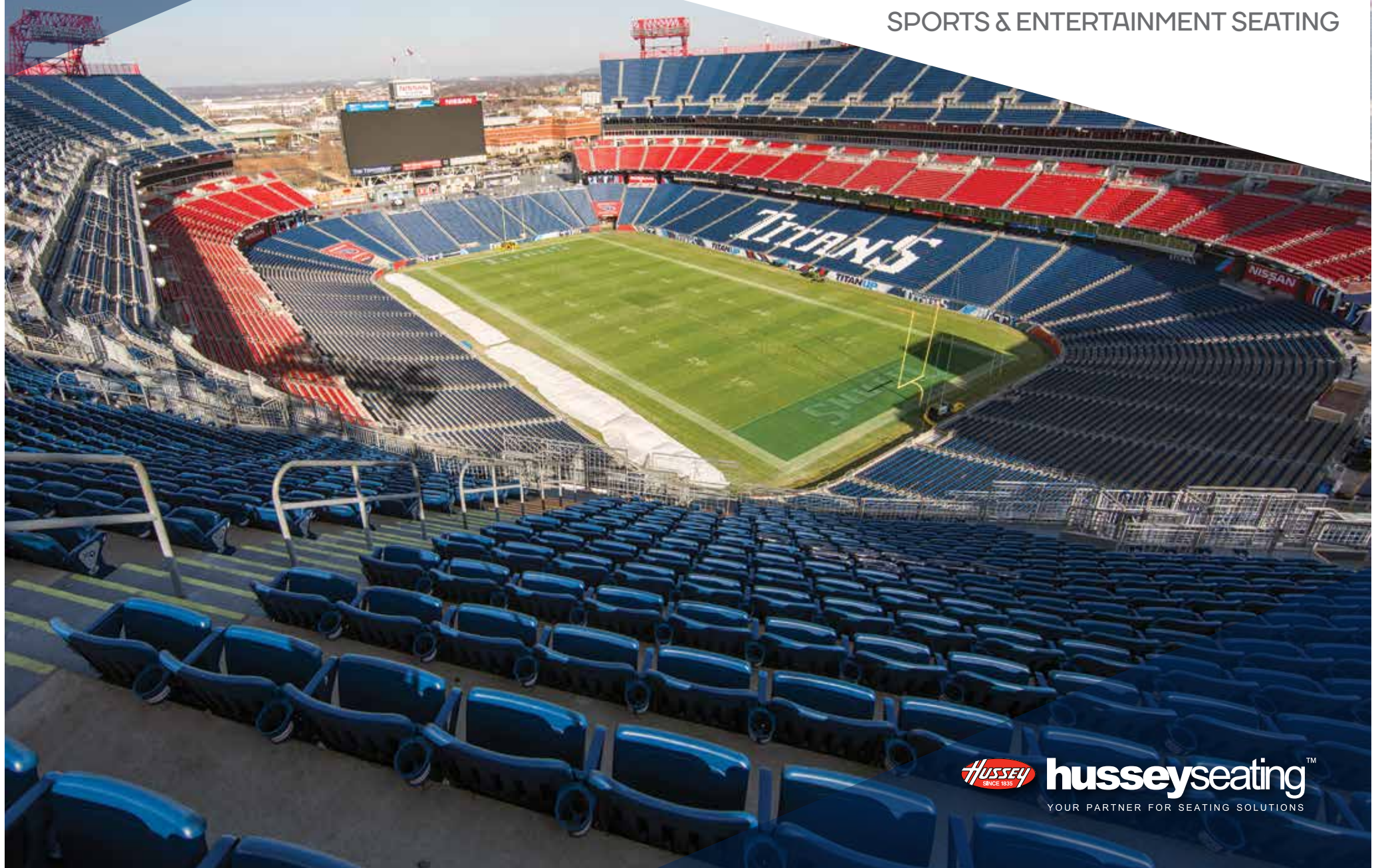

HUSSEY
SINCE 1950

husseyseating™

YOUR PARTNER FOR SEATING SOLUTIONS

MORE THAN JUST A GAME

A fan's seat is often the foundation of their entire experience at a game or event. Shouldn't your seats have as much thought put into them as you've put into the rest of the fan experience? We think so.

Here at Hussey Seating, we know a comfortable fan is a returning fan. That's why we put so much thought into designing our seats specifically for spectator events. Details like recessed hardware, ergonomic contours, and durable components combine with our decades of expertise to create comfortable seats that last season after season.

Our tradition is to listen to you, understand your unique needs, and collaborate with you to create the perfect solution. The result? Seating tailored specifically for your venue, no matter what type you need and where you need it. Durable seats that can stand up to thousands of spirited people, year after year. And comfortable fans who can't wait to come back for more.

THE SPORTS & ENTERTAINMENT SEATING

SOLUTIONS

Seat Styles	4
Fusion	6
Legend	8
Quattro Extreme	10
Options	11
Dimensional Data	13
Resources	14

Cover Photo
Fusion Seats
Nissan Stadium • Nashville, TN
Populus

DESIGNED TO PERFORM

Our decades-long history of seating the biggest and best sports facilities has provided us with a wealth of knowledge that makes our products the most reliable performers in the industry. We are dedicated to bringing our world-class quality to seating projects of every size.

Whether you are seating a few hundred fans or tens of thousands, Hussey Seating offers you the same quality, comfort and engineering innovation that we use in our professional-grade installations around the world. From small schools and local amphitheaters to leading universities and pro sports venues, Hussey delivers the perfect seating solution for your space. No one can offer more expertise in spectator seating of every kind, backed by an unrivaled network of local experts ready to assist you for the entire life of your seats.

Fixed and Nose Mount Quattro® Chairs
Air Canada Centre • Ontario
Brisbin Brook Beynon Architects

LONG-LASTING QUALITY

Hussey offers the most reliable line of fixed chairs in the industry today. Our Fusion™, Legend™, and Quattro Extreme™ chairs have the proven strength and easy-cleaning convenience to withstand even the most raucous crowds, harshest weather conditions and messiest concession foods — year after year. We maintain strict quality controls throughout the production process, using state-of-the-art molding and solid cast aluminum or cast iron standards for all of our chairs. And it's all backed by the industry's best warranty.



Legend Seats
Dow Diamond • Midland, MI
Populous



FUSION™
Combining invincible strength with style and comfort, Fusion features contemporary lines, a smooth polished finish and unrivaled performance.



LEGEND™
It's seating fit for a legend. Designed for comfort, durability and value, Legend is a classic choice for the ballpark and beyond.



QUATTRO EXTREME™
Get the luxury of an upholstered indoor chair with the durability of an outdoor stadium seat when you choose Quattro Extreme.

FUSION™

The Fusion seat is the successful result of years of product development and testing. Combining the best features of two prior models – the invincible strength of the Olympiad and comfort of the Medallion – Fusion was born. Designed to stand up to the elements and rigors of a demanding sports and entertainment venue, Fusion seats will last season after season. Plus, the Fusion seat is contoured for ergonomic support to improve the spectator experience. And with contemporary lines and a smooth, polished surface, the seat looks as good as it feels.



Fusion Seats
Nissan Stadium • Nashville, TN
Populous



Sturdy solid cast aluminum stanchions are rust-proof and remain cool to the touch, even under the hot sun.

Ductile cast iron hinge arms and threaded steel metal-to-metal fasteners add durability.

For extra comfort and style, the seat features no exposed hardware, and the through bolts on the back are recessed.

Choose from a wide range of standard or custom colors to complement your stadium and team colors.

For greater flexibility, we offer a complete line of accessories and custom options.



Bringing Fusion™ Indoors

Bring the comfort and durability of Fusion to your indoor fixed seating. Yukon High School chose Fusion seats for their fixed indoor gymnasium due to the exceptional comfort and easy installation into their existing concrete bleachers.



Preferred Seating

Not only does Fusion withstand the outdoor elements, it also creates impressive and comfortable preferred seating areas. These areas often bring in more revenue for boosters and team funds.

LEGEND™

Ballpark seating gets a new lease on life with the classic Hussey Legend. Designed for comfort, durability and value, the Legend is equally at home in minor-league ballparks and schools as it is in big-league stadiums and arenas. Beyond the ballpark, Legend can be a versatile choice in many different venues, including indoor facilities.



Legend Seats
Kauffman Stadium • Kansas City, MO
Kivett and Myers / Populous



Legend™ features a durable, blow-molded slatted back with a durable polymer seat.

Available with padded or upholstered seats.

Includes detailed cast iron standards that can be customized for your facility with an integral cast logo.

Choose from a wide range of standard or custom colors to complement your stadium and team colors.

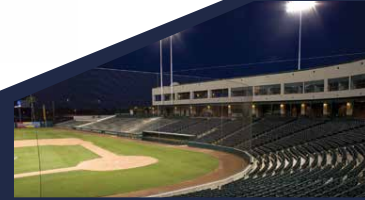

Comfortable in the Spotlight

When the Arizona Sports and Tourism Authority undertook a \$20 million renovation of Tempe Diablo Stadium in Tempe, AZ, they turned to Hussey Seating to provide the experience, the expertise and the right seating solution, the Legend chair.



Bringing the Legend Indoors

Beyond the ballpark, the Legend can be a versatile choice in many different seating applications. At the Conscoco Field House arena in Indianapolis, Legend chairs were used exclusively to maintain a consistent look throughout the facility. Hussey provided a combination of all-plastic Legends, padded Legends and custom-engineered fold-down Legend chairs mounted on Hussey telescopic platforms. This unique indoor installation has proven to be a hit with the owner, the architect and the fans alike!

QUATTRO EXTREME™

Quattro Extreme combines the luxury of an upholstered indoor chair with the durability of an outdoor stadium seat for your open-air seating. Rugged and weather-resistant, Quattro Extreme has rust-proof stanchions, corrosion resistant hardware, and marine-grade fabric to protect your seats while offering spectators the most comfortable outdoor seating experience.



Quattro Extreme Chairs
Davis Wade Stadium - MSU • Mississippi State, MS
LPK Architects / 360 Architecture



Solid cast aluminum stanchions won't rust, even if the finish is nicked. Each component is finished individually before assembly, which ensures full encapsulation for maximum protection against the elements.

Stainless steel hardware is corrosion-resistant.

Exterior-grade plastic and marine-grade Naugahyde resists UV light and mildew.

Inner seat and back panels feature marine-grade plywood made from Okoume wood veneers (naturally resistant to moisture and mildew) and water- and boil-proof (WBP) glue.



Outdoor Luxury

Make an impact on your most important revenue-generating guests with luxurious fixed seating that will hold up to the elements. We'll help you create a custom layout like we did at Arrowhead Stadium in Kansas City, MO, that's sure to impress even your most exclusive of guests.



Custom Logo

Put the final touches on your VIP seating areas with a custom logo on the end of each seating row.

Special-Needs Features, Options and Accessories

Innovative options, accessories and special-needs features put Hussey in a league all our own. Hussey Seating gives you the flexibility to customize a solution for any venue — including innovative features to keep your facility compliant with all ADA, state and local regulations regarding special-needs access.

ADA Solutions



Flip-up and Armless Chairs
We offer solutions for semi-ambulatory spectators who need to easily slip into a regular seat. The flip-up arm allows access into end-row chairs and can be easily flipped down for a full armrest once the patron is seated. Both types can be used for standard seating when maximum capacity is required.



Skid-Mounted and Companion Chairs
Seats are mounted on skids for standard seating, and the entire assembly can be unbolted and removed at a moment's notice to accommodate wheelchair patrons. Adjacent chairs remain available for companion seating. Sections are available in 2-chair (approximately 467/1168 mm) or 3-chair (approximately 667/1676 mm) widths to fit one or two wheelchairs.



In-Fill Decks
To help you meet ADA code, the top two rows of chairs below the cross-aisle or concourse are removable, and can be in-filled with an aluminum platform at the same elevation as the cross-aisle. Wheelchair patrons can wheel across the concourse and directly onto the platform. When not needed, this flexible option allows you to recover the two rows of fixed chairs, maximizing your facility's revenue potential.



Roll-A-Way
This feature is made from floor mount stanchions attached to a steel base with tubular supports. Four swivel casters are mounted on hinged plates to either fold underneath for easy mobility or fold up out of the way when secured to the floor. Available in 2-chair (approx. 467/1168 mm) or 3-chair (approx. 667/1676 mm) widths to accommodate one or two wheelchairs. Adjacent companion chairs can be permanently installed.

Options & Accessories



Integral Logo
Your team or facility's logo can be integrated into each chair's cast iron end stanchion. Vinyl appliques can be added to color the logo.



Fusion™ Logo Plate
With Fusion's optional logo plate, graphic or cast logos can be applied at time of installation or at any point in the future.



Redirected Seating
Seats can be angled 12 degrees towards home plate, reducing neck strain. (Legend standards only).



Expansion Joints
Various plates are available for different attachment methods to accommodate expansion joints in the seating bowl.



Cup Holders
Cup holders can be attached to chairs for spill-proof convenience. Multiple styles and configurations are available, including back-attached (bolt-on or clamp-on), wall-attached and rail-attached.



Padded Backs
For extra comfort, soft padded backs on our Fusion chairs are a popular option.



Padded Seats
Foam and fabric pads add style and comfort to any of our polymer chairs.



Upholstered Seats
Add cushioned comfort with a fully upholstered Quattro Extreme™ seat while maintaining the rugged practicality of a blow-molded polymer back. Or combine with a padded back for even more comfort!

Standard Colors & Options



Fusion & Legend Colors
Fifteen standard colors are available for all chairs; custom colors are available on request.



Quattro Extreme Colors
Five standard colors are available for all chairs; custom colors are available on request.

Note: Production molded parts and paint colors will vary from printed samples shown. Please request a production sample or color chip when selecting an actual color.

Seating Layout & Dimensional Data

Our Legend™, Fusion™ and Quattro Extreme™ chairs come in a variety of configurations to suit any purpose. Using the options on the previous page and the drawings and information listed here, you can choose any combination of these chairs to develop a custom Hussey Seating solution.

Stanchion Mounting Options

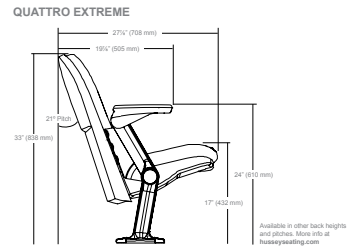
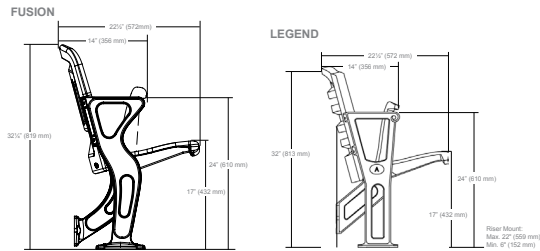

Calculating Row Length

These examples illustrate how to maximize the number of seats and calculate spacing for your custom design solution.

- End spacing is 2" (51 mm) per aisle end for a total of 4" (102 mm) per continuous row.
- Note that many row lengths have varying chair size combinations not shown in these examples.

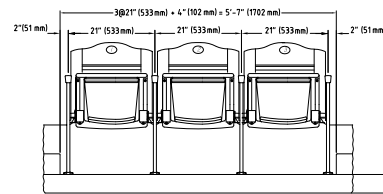

General Notes:

- All Pre-Cast or Poured-in-Place concrete treads must be a min. 4" (102 mm) thick with the top 2" (51 mm) clear of rebar.
- All Pre-Cast or Poured-in-Place concrete risers must be a min. 4 1/2" (114 mm) thick. Proper anchorage will require the first 3" (76 mm) to be free and clear of rebar or any other obstruction.
- All normal concrete must have a min. strength of 3000 psi for proper anchor attachment.
- All light weight concrete must have a min. strength of 5000 psi for proper anchor attachment.
- All steel risers must be a min. 1/4" – 3/8" (6-10 mm) thick Grade A-36 steel.
- All wood floors must be a solid min. 1 1/2" (38 mm) thick.

Seat Width Options

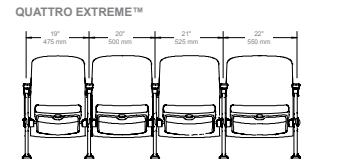
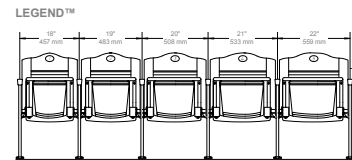
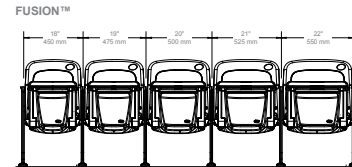

Sustainability

At Hussey Seating, respecting the landscape we live in—and the hard work and well-being of the people we work with—has always been in our DNA and part of our heritage. Our commitment to environmentally friendly business practices has taken many forms over the years as standards and technology have changed.



In the 1970s, when the rest of the nation began to become more environmentally aware, we had already laid walking trails and planted a tree farm on our beautiful Maine campus. Today, going green means developing environmentally friendly paints and finishes, sourcing sustainable woods and metals, going beyond local and national regulations in clean manufacturing and waste disposal, and making deliveries on time while reducing our carbon footprint. We reduced our air emissions by 90% while tripling our seating business, so we know green business is good business.

Hussey seating solutions come in a wide range of colors—but every day our seats get greener. If you'd like to learn more about our sustainability efforts, please visit our website at www.husseyseating.com/sustainability

Resources

For all of MAXAM's accessories, surface materials, fast facts, environmental data sheets and more go to HusseySeating.com.

News & Updates

Web: HusseySeating.com
Facebook: facebook.com/HusseySeating
Twitter: twitter.com/husseyseating
YouTube: youtube.com/user/hscpublic
LinkedIn: linkedin.com/company/hussey-seating-company

Warranty

Our factory-backed warranty is the best in the industry.

Interior Warranty
 Limited Lifetime: structure
 5 years: components

Exterior Warranty
 Limited Lifetime: structure
 5 years: components
 3 years: foam, powder coat finish
 1 year: upholstery stitching and thread, polymer finish

Expert Support

It's standard equipment on every Hussey product.

- Safety Inspections
- Service Contracts
- Accessories
- Custom Fabrication
- Factory-Certified Parts
- Renovation & Repair

Toll-Free (USA) 1.800.353.3308



Legend

fusion™

Quattro
EXTREME

Hussey Seating Company™

The Hussey Seating Company story dates back to 1835 with William Hussey's tremendously successful plow design, and thus, the Hussey Plow Company was born. As times changed over the next sixty years, the family set about reinventing the business, evolving into the company that is now seating the world. Today, under the sixth generation of family leadership, Hussey Seating Company is proud to be known as the leading manufacturer of seating solutions throughout the world – in stadiums, arenas, schools, universities, colleges, places of worship and anywhere people gather.

Your partner for seating solutions.



husseyseating™

YOUR PARTNER FOR SEATING SOLUTIONS

38 Dyer Street Extension
North Berwick, Maine 03906 USA
Toll Free (USA) 1.800.341.0401
Tel: +1.207.676.2271
Fax: +1.207.676.2222
info@husseyseating.com
www.husseyseating.com

Regional Offices:
Europe & Middle East
Hussey Seatway
www.husseyseatway.com
Asia-Pacific
Hussey Asia-Pacific
www.husseyasiapacific.com

©2017 Hussey Seating Company. All rights reserved. Hussey Seating™, Legend™, Fusion™ and Quattro Extreme™ are registered trademarks of Hussey Seating Company.

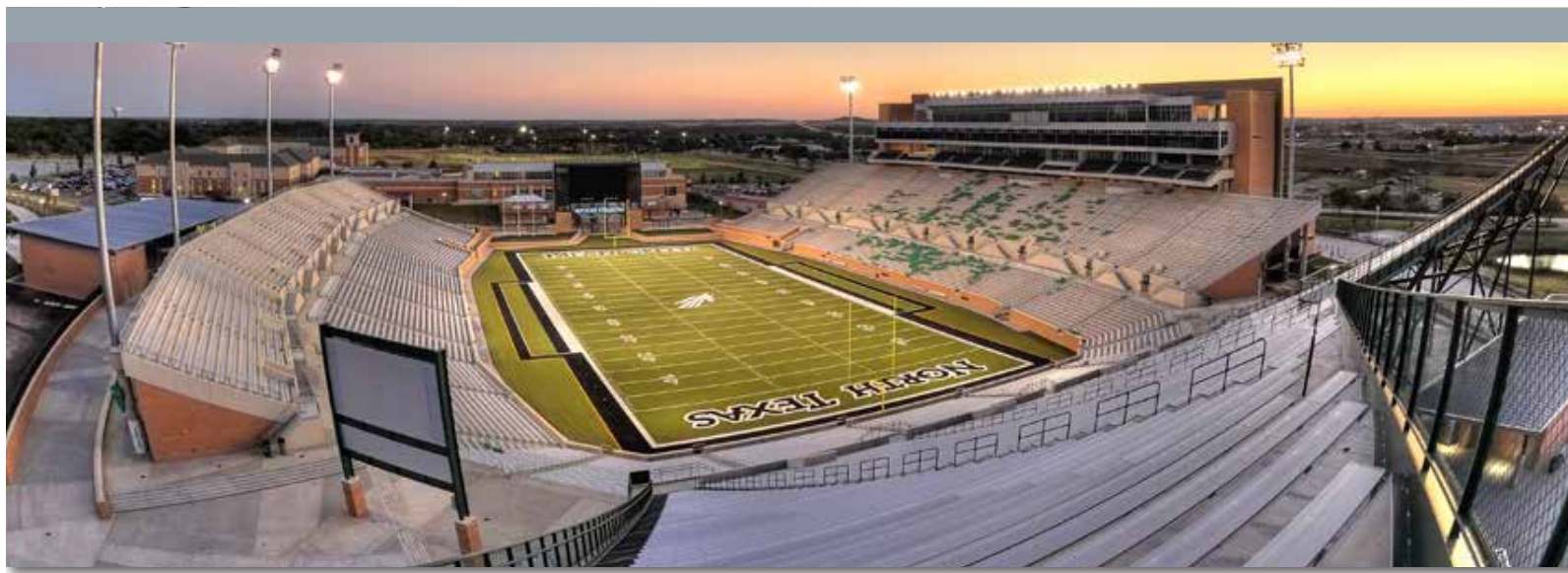

Apogee Stadium - University of North Texas

ALUMINUM SEATING On Concrete



Ellis Davis Fieldhouse - Dallas, TX



Denton ISD - Denton, TX



Folsom Field - University of Colorado

Solutions for Concrete

Our aluminum extruded seating planks install quickly, easily and economically on new concrete structures and offer an effective solution for expansion or renovation of existing facilities.

Sturdisteel extruded aluminum planks are in a class by themselves for quality, durability and low maintenance - providing spectator comfort for all types of sporting events.

Whatever the event, aluminum bench seating is the most used and cost effective way to maximize the number of seated viewers for a particular space.

The Industry Standard

Sturdisteel is a recognized industry leader in spectator seating solutions. With thousands of installations across North America, our clients include some of the finest sports facilities in the world.

Recommended for:

- | | | |
|----------|-------------|----------|
| Football | Baseball | Softball |
| Soccer | Lacrosse | Tennis |
| Track | Motorsports | Aquatic |
| Rodeo | Exposition | Ice Rink |



New or existing. Large or small.

The most effective seating for steel and concrete facilities.

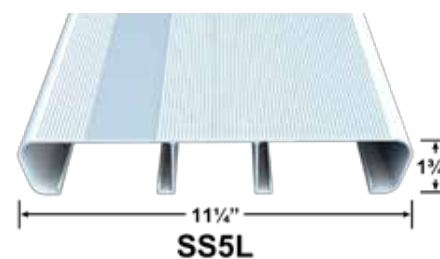
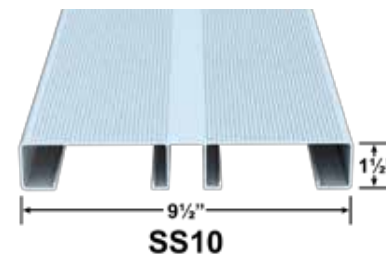
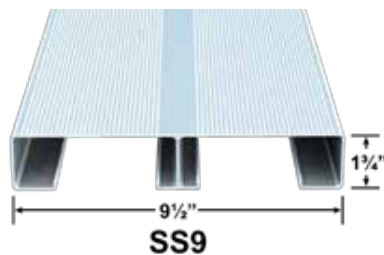

Features

- Rugged aluminum extrusion alloy 6063-T5
- Four different seating models and widths
- Serrated surface with 2" flat strip for numbering
- Lengths of 8'- 30'
- Clear anodized finish

Options

- Matching backrests and armrests
- Contoured backrests
- Clear anodized or powder coat
- Powder coated finish on backrest



P.O. Box 2655, Waco, TX 76702-2655

TEL: 254.666.5155

FAX: 254.666.4472

TOLL FREE: 800.433.3116



Sturdisteel is a Division of Schultz Industries, Inc.



STURDI Series 6000



Stadium Chairs

The Sturdi Series 6000 represents our top of the line stadium chair, offering tremendous versatility for any venue requiring a premium option for VIP seating.

With installations all across the U.S., the Sturdi Series 6000 has proven its durability by standing the tests of time, weather, and intense spectator use.

This rugged chair is offered in a variety of configurations and suitable for new or existing facilities and steel or concrete understructures.

Features:

- Manual rising seat (self-rising optional)
- Extruded aluminum alloy
- Clear anodized aluminum seats and backs
- Offered in 19", 20", 21" and 22" center to center
- Optional Powder coated finished backs
- Five Year Limited Warranty



Sturdisteel is a Division of Schultz Industries, Inc.

P.O. Box 2655, Waco, TX 76702-2655

TEL: 254.666.5155

FAX: 254.666.4472

TOLL FREE: 800.433.3116



www.Sturdisteel.com

STURDIWRAP™

STADIUM BANNER SYSTEMS

"The bleacher wrap is absolutely fantastic! It's the most talked about feature of the stadium." – Kerrville ISD



Durable and long lasting stadium wrap solutions for athletic facilities.

Enhanced Aesthetics

Custom designed and professionally installed on new or existing structures- transforming your facility with impactful graphics.

Generate Revenue

Maximize your sponsor's advertising impact by turning what is most likely, the largest square footage available in your stadium, into a highly-visible billboard.

Create Storage

Turn your open space into necessary hidden storage and eliminate fan traffic under the bleachers.

Applications

- Bleacher front, side or back
- Stadium signage
- Sponsorship banners

Features

- PCV coated polyester mesh
- 30% allowable wind flow
- Galvanized steel hardware
- One year warranty



P.O. Box 2655, Waco, TX 76702-2655

TEL: 254.666.5155

FAX: 254.666.4472

TOLL FREE: 800.433.3116



SturdiSteel is a Division of Schultz Industries, Inc.

www.SturdiSteel.com



TEAM Benches



Length	Net Seats
9'-0"	6
15'	10
21'	14
27'	18

Exceptional Value

Sturdisteel aluminum team benches feature rugged extruded aluminum seats with your choice of galvanized or aluminum frames on select standard lengths. Designed for heavy-duty, commercial use and low-maintenance, our team benches are a compliment to your new facility or as an addition to an existing one.

Features:

- Galvanized steel or optional aluminum frames
- 2 x 10 anodized aluminum bench seats
- Portable, surface or permanent mount
- Standard lengths of 9'-0", 15', 21' and 27'
- Custom lengths available
- Optional aluminum backrest
- Optional powder coated backrest
- Galvanized hardware included
- Five Year Limited Warranty



Sturdisteel is a Division of Schultz Industries, Inc.

P.O. Box 2655, Waco, TX 76702-2655

TEL: 254.666.5155

FAX: 254.666.4472

TOLL FREE: 800.433.3116



www.Sturdisteel.com

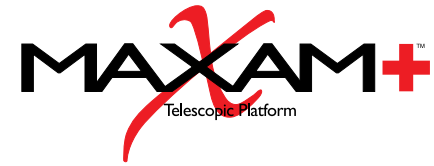

TELESCOPIC PLATFORM SEATING

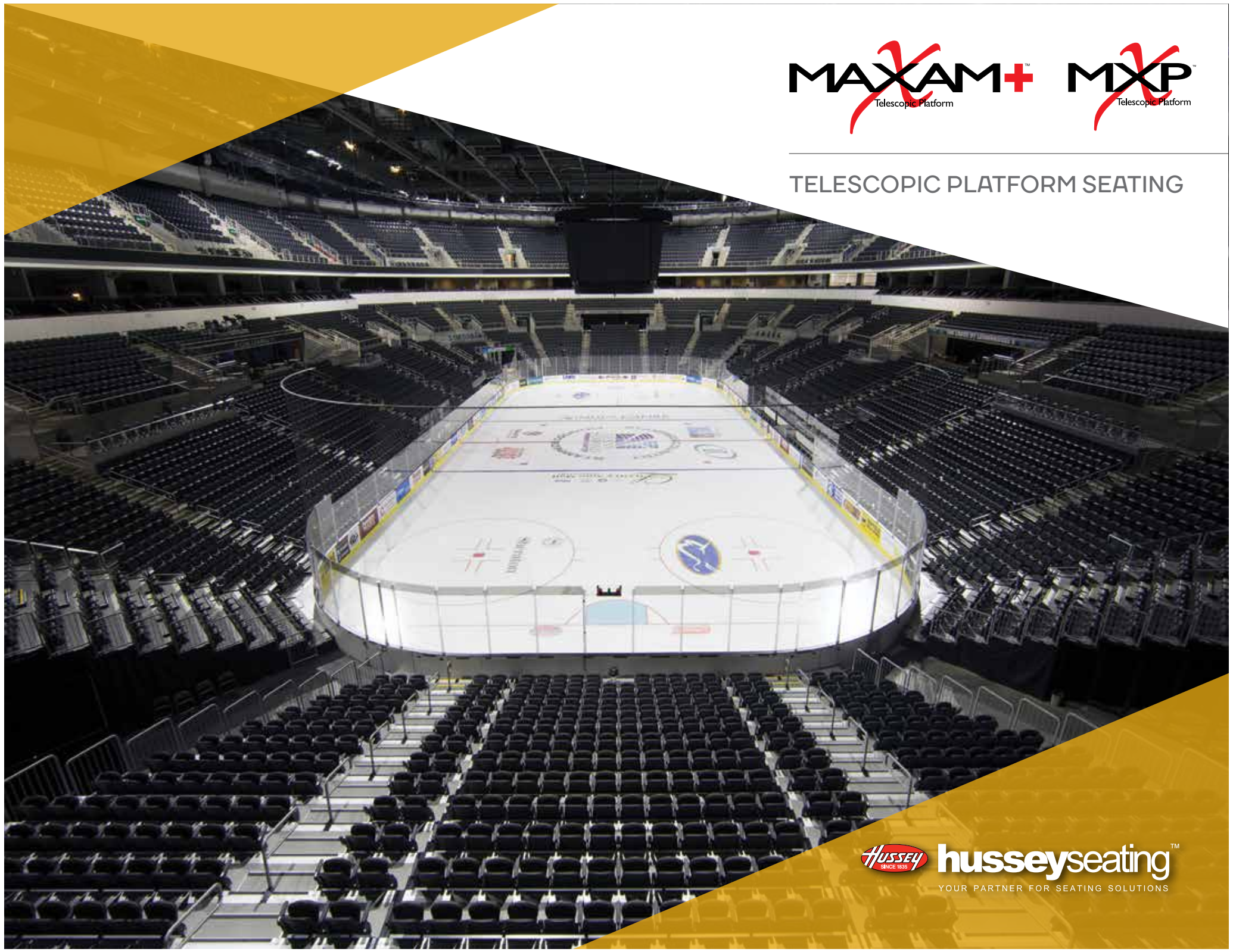

husseyseating™

YOUR PARTNER FOR SEATING SOLUTIONS

CREATING A MORE FLEXIBLE SPACE

Audience spaces come in every size, shape, and form today – ranging from intimate performance halls to the largest arenas in the world. At Hussey Seating, we know you need a seating solution that provides the greatest flexibility to make the most of your space.

Hussey Seating has a long tradition of providing high quality seats and cutting edge telescopic systems. All our expertise comes together in our line of telescopic platforms to deliver the form, fit, function, finesse and flair that multi-use facilities have been waiting for.

We know that the key to developing and providing the perfect seating solution is an understanding of each customer's unique needs. We start by listening, then collaborate with you to create the telescopic seating solution that will fulfill your vision and create the perfect audience seating for your space.

TELESCOPIC PLATFORM SEATING

SOLUTIONS	APPLICATIONS
MAXAM+™	2
New Dimension of Comfort	4
Seating Options	5-6
The Total Package	7-9
Seating Customization	10
Understructure	11-12
Rail Options / Media Platform	13
Other Options	14
Wall Attached	16
Reverse-Fold	16
Recessed	17
Portable & Freestanding	18
SPECIALTY PLATFORMS	
MXP	19-21
MXP Understructure	22
Hussey Seatway	23-24
Dimensional Data	25
Resources	26

Cover Photo
MAXAM+™ Telescopic Platform w/ Quattro Chairs
Xavier University • New Orleans, LA
Landis Construction

GREAT PERFORMANCES

Multi-use environments like gymnasiums, arenas, convention centers, and performing arts facilities that demand multiple, flexible seating configurations greatly benefit from Hussey Seating™ telescopic platform seating. Safe, easy bleacher operation, reliable performance, great looks, smart seating upgrades and the seating industry's best warranty make Hussey Seating telescopic platform seating your star player.

MAXAM+™ Telescopic Platforms are expertly engineered to meet the seating needs of a wide variety of applications and venues, from school auditoriums to small and mid-size sports and entertainment arenas. Endlessly configurable and easily upgradeable, MAXAM+ lets you reclaim the most indoor event center floor space and make the most of your facility's seating budget.

MXP™ Telescopic Platforms are built strong and smart for multipurpose event centers like professional arenas, convention centers, and community event centers. Providing maximum performance and reliability, ease of setup and operation, and the premium upholstered seating your customers demand, MXP combines the best of operational functionality with spectator luxury.

Great for "black box" auditoriums and theaters, Hussey Seatway™ Telescopic Platforms provide a space-saving retractable 'space frame' seating platform that can also deliver the fit, finish and stylish comfort to satisfy the most sophisticated audiences. Hussey Seatway is completely customized for your performance space and tailored to your seating needs.

MAXAM+™ Telescopic Platform w/ Upholstered Metro Chairs
Eden Hall • Gibsonia, PA
Eckles Architecture

MAXAM+™ TELESCOPIC PLATFORM

Available with our full line of seating from our premiere Quattro, Gallery, and Metro lines, to budget friendly Premia or Courtside seating collections, MAXAM+ is great for small to medium size entertainment facilities. With features like custom and variable rise, tapered sections and extruded aluminum decking, MAXAM+ is ready to perform in the most demanding audience environments. Whether it's a full house for game day in your arena, or opening night for a major production in your performing arts center, we can provide the solution to execute your vision and meet the unique needs of your facility.



MAXAM+ Telescopic Gym Bleacher w/ Metro Chairs
Montana State University • Bozeman, MT
Tutt Construction

A New Dimension of Comfort

With the wide variety of seating solutions that MAXAM+™ can support, a comfortable seating solution is just around the corner. All seats are available in both telescopic and fixed versions, allowing an aesthetic continuity throughout a facility.

Easily fitting into both new and existing facility dimensions—our telescopic seating systems allow easy adjustment and make future maintenance, chair replacement and upgrading a breeze. State-of-the-art composite finishes and fully integrated systems allow maximum seating—while providing patrons with a singularly comfortable seating experience.



A-B Quattro Classic Series
Shown as a Forward Fold. Available in nose mount, fixed, and portable stacking options. The Quattro Classic Series blends the comfort of a premium auditorium chair with the flexibility of telescopic seating platform, making these high value locations truly the best seats in the house. Designed to decrease labor costs and changeover time, platforms with Quattro Classic can efficiently change from stored to event-ready with each staff member operating rows of up to 14 chairs at a time for a single operator.

C. Gallery 3
Shown as Fold Down Upholstered. Gallery 3's contemporary European styling gives your facility a fresh look and enhances the experience of your patrons.

With multiple chair widths available, your attendees will enjoy even lengthy performances. Available in manual, lift-assist, and semi-automatic, these rail mounted seats with a surprisingly slim envelope can be event ready with minimal effort.

MAXIMUM SEATING OPTIONS

Ranging from fold-down chairs and benches to polymer gym-seat modules, MAXAM+™ telescopic platforms can support a wide variety of audience seating options.

CourtSide™ Modular Gym Seats

Designed to fit anywhere on your MAXAM+ units, CourtSide is completely modular. CourtSide seat modules, backrests and seat spacers are just the ticket for seating spectators in truly comfortable bleacher seats – a welcome surprise for your fans. You can use all three types of modules throughout your gym, or mix and match to create different levels of seating within the same bleacher bank. Easily create a first row of integrated team seating, or build a section of reserved VIP seating for season ticket sales to your boosters.



MAXAM+™ Telescopic Platform w/ Quattro Chairs
Xavier University - New Orleans, LA
Landis Construction

Seating Options



Metro Upholstered and Polymer

Metro's innovative and distinctive design incorporates both comfort and style. The entire seat is molded using advanced engineering polymers, and is available in 18", 19", 20", 21", and 22" (450 mm, 475 mm, 500 mm, 525 mm, and 550 mm) standard widths (or any variation in-between). Metro has a full line of arm options including polymer, upholstered and wood, as well as cup holders, and many other accessories.

Premia Upholstered

With a sprung foam seat and back, the fully upholstered Premia chair offers big comfort in a small package. This low-maintenance chair with folding backrest offers an innovative way to provide ergonomic comfort in a compact individual chair with semi-automatic operation.

Seating Customization



Premia Polymer

The same design as the Premia Upholstered, the Premia Polymer is an affordable alternative with the increased durability that Polymer offers. No sacrifice to design is necessary as Polymer options come in 19 different colors to match your desired color palette.

Upholstered Bench Seats | Club Bench

The Club Bench closes into a small space, allowing for a minimum rise per row of just under 10½" (260 mm). The manual folding, preformed plywood seat and back come with your choice of upholstery. Also available without the backrest.

CourtSide 12 and 10 with Backrests

Ergonomically designed for maximum comfort to provide ideal low- and mid-back support. Also engineered for maximum fan safety and easy bleacher cleaning. One person can raise or lower up to seven interconnected backrests at a time to minimize labor and operational costs.

THE TOTAL PACKAGE

From our brand new XtremeLogo™ bleacher graphics that make your gym come alive to our Clarin® portable logo chairs, the Total Package Graphics Program helps create the ultimate gymnasium. Inspire your team, students and community with vibrant colored rails, spirited CourtSide™ Contour Backrests, integral CourtSide seat graphic logos, vivid Safety End Closure Curtain graphics, exciting Media Platform Rail Sleeve graphics, and our sleek new StepSigns™ and CourtSigns™. The customization options are nearly endless!

"The bleachers have generated a great deal of school pride with our student body. The kids are so proud when players from opposing schools come into the gym and comment on how beautiful the bleachers are. They've turned a nice gym into a state of the art gym...it's stunning!"

Dennis Walton, CAA, Athletic Administrator
Biddeford High School, Biddeford, Maine



MAXAM® Telescopic Gym Bleacher w/ The Total Package
Biddeford High School • Biddeford, ME
Harriman Associates



XtremeLogo
The cornerstone of the Total Package Graphics Program, the XtremeLogo places your school's mascot or logo on a grand scale in the center of your bleacher sections. Using a proprietary graphic transfer process, your XtremeLogo is permanently bonded to the CourtSide bleacher seats – no peeling, scuffing or scratching. Whether the bleachers are opened or closed, your logo will impress.

Clarin Portable Sideline Chairs
The choice of colleges and pro teams nationwide, Clarin portable chairs offer state-of-the-art logo customization for backs, seats and even seat gussets. Durable, full-color imprints of your mascot, logo, and spirit message give big-league sideline impact. Clarin's proven worry-free dependable performance is legendary, delivering decades of service with the flexibility of interchangeable seats and backs.

CourtSide™ Graphic Logos
CourtSide gym seat modules offer a spot for every fan to see your school's logo or mascot at the end of each seating area. These durable, full-color custom graphic logos can even be individually customized for section designation.



StepSigns™
These ultra-durable full-color signs are pre-applied to the front of bleacher aisle steps during manufacturing. Offering full-color to single color imprinting, they are a great place to remind students, fans and competitors of your school motto or spirit message.

CourtSigns™
Featuring the same material and imprinting options as StepSigns, CourtSigns are pre-applied to the bleacher skirt boards during manufacturing. Their longer runs and placement make them ideal for ringing the court with your school name.

Media Platform
The rail sleeves of both detachable or permanently installed Media Platforms are the perfect spot to bring together your full-color logo, mascot, school name and spirit message to top off your bleachers with a message visible from anywhere in your gym.

THE TOTAL PACKAGE (cont.)



Portable Chair Storage Carts

Put an end to haphazard sideline chair storage with our specially engineered Clarin® chair storage carts. Make set-up and break down a breeze by using stacking, hanging, flat or studio carts to keep your chairs organized and all in one place.



Backrests and Seat Spacers

Contrasting color CourtSide™ CB contoured bleacher backrests deliver truly comfortable bleacher seating and turn up the spirit. They can be incorporated anywhere on your bleachers, with or without seat spacers.



Colored Rails

Your bleacher aisle, end, front and rear rails carry on your school's color scheme in one or more colors. Choose from a variety of standard color options or custom color matching to bring out school pride with a punch of color.

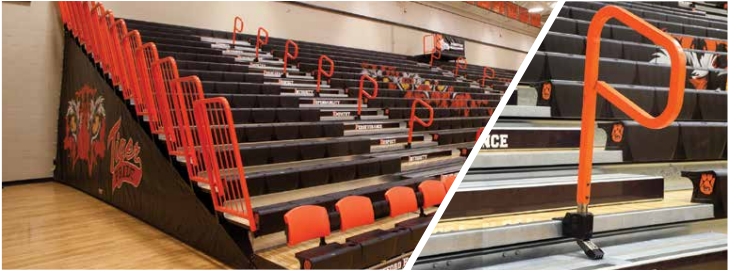

Safety End Closure Curtain

MAXAM® bleacher end curtains boost gym security while displaying your school pride. Vibrant full-color customization can run all the way off the edges in large full-bleed designs to wow people with your spirit as soon as they walk in the door.

Auto-Rotating Center Aisle Rails

This Patent pending rail is permanently mounted to the bleacher, and automatically rotates to the proper open or closed position as you operate the bleacher with the push of a button. No tools, no labor, no more missing or improperly positioned rails.

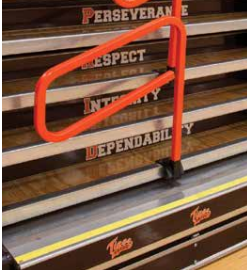

Signature Logo Program

Your local Hussey dealer will work with your community or school to develop a logo design that makes everyone proud. With the MAXAM+ Signature Logo Program, it is easy to create the most colorful and spirited bleacher logo design.

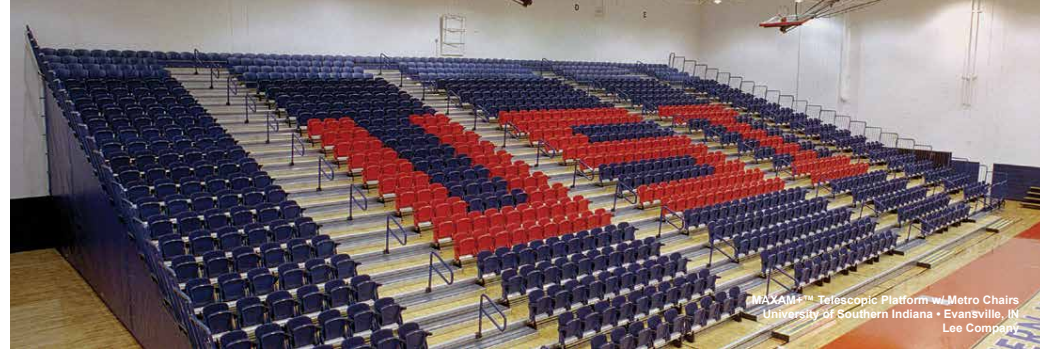

MAXAM™ Telescopic Platform w/ Metro Chairs
University of Southern Indiana • Evansville, IN
Lee Company

SEATING CUSTOMIZATION



Signature Logo Program

Your local Hussey dealer will work with your community or school to develop a logo design that makes everyone proud. With the MAXAM+ Signature Logo Program, it is easy to create the most colorful and spirited bleacher logo design.

Standard Colors

The CourtSide™ XC10 and XCS12 are available in 15 standard colors (top 3 rows) and Metro is available in all 19. For accent lines, attention-grabbing signature logos or sticking with a solid color theme, select CourtSide or Metro as your ideal seat. Production polymer and powder coat colors can vary from printed samples shown, so Hussey makes sample chips available upon request. Custom color matches are also available.

Flex-Row™

Create an endless variety of lock-in configurations to accommodate constantly changing needs like team seating, wheelchair access and scorer's tables. Available with CourtSide™, Metro™, Club Bench and Gallery 2 seating.

UNDERSTRUCTURE

Performance, Flexibility and Safety



A. Posi-Lock™ LX

These automatic row locks prevent accidental closure when the system is in use. This patented, innovative, low-profile design minimizes the chance of accidental damage, ensuring consistent operation.

B. Nose & Riser Beam

These rolled form structural members provide continuous deck support, and are through-bolted to the frame and stabilizers. These designs deliver unparalleled strength, durability and rigidity.

C. Continuous Positive Interglide

This interlocking glide system is a rigid, one-piece formed design which tracks better and operates easier than systems with 1/2" (13 mm) row to row engagement. The 10" (254 mm) minimum interlock provides the industry's most rigid, stable design. Our wheels are 5" (127 mm), resulting in less rolling friction.

D. Captive Interlock & Adjustable Row Stops

The Captive Interlock System engages and aligns deck to deck. In addition, MAXAM® can be configured for three different row-spacing setups—adjustable on-site if required. MAXAM incorporates three stabilizer assemblies per section to provide improved tracking and stability.

E. Independently Locking Flex-Row™

Each Flex-Row is equipped with an independent self-locking mechanism to deliver maximum flexibility, performance and safety.

F. Full-Length Captured Decking

Decking is captive in the riser beam and rests on the nose, firmly secured by the seat bracket. This system provides a stiff, secure walking surface with no exposed hardware. MAXAM is the only telescopic gym seat that utilizes transverse decking, using decking materials in accordance with their industry span rating. Thoroughly load tested and independently verified, MAXAM's continuous full-length deck support system provides an enhanced level of performance, safety and stability.

G. Slant Frame Design

Load-tested and certified for 30 tier single stack sections up to 25' 6" (7772 mm), our slant frame design delivers improved cantilever strength and capacity. It also simplifies the installation process, reducing downtime for the facility. Critical support areas are all fastened with bolts, lock washers and hex nuts. Only MAXAM incorporates a steel to steel connection where the frame meets the wall, creating a stronger union and a safer gym seat.

H. Tension Bracing

Through bolted to the frame to provide additional stability. All bracing is coined to remove sharp edges, and all ends are rounded for safety.

Rail Options



New Auto-Rotating Center Aisle Rails

Hussey's breakthrough center handrail design ensures your patrons will always find a secure handhold while moving up or down the aisles – while dramatically reducing the labor of properly opening or closing your gym bleacher. This Patent pending rail is permanently mounted to the bleacher, and automatically rotates to the proper open or closed position as you operate the bleacher with the push of a button.

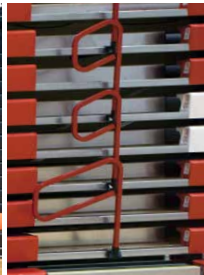

Colored Rails (Left)

Carry your color scheme throughout the facility with one or more of our palette of standard colors to show your school spirit. Aisle rails, end rails and front or rear rails can all be customized to match your school colors. Ask your Hussey dealer for more information.



Center Aisle Hand Rails

Safety rails include fixed, folding and removable options and feature a safe, fully closed design.



Fixed Front and Rear Rails

An ideal solution for truncations, elevated front aisles, freestanding, portables and reverse fold systems. All rails maintain a consistent design appearance.

Media Platform

Perfect for videotaping, photography, radio broadcasting or team talent scouting, the Hussey Media Platform creates a workable space for covering all the action. Optional rail sleeves can be customized to promote school spirit or generate revenue.



Fold & Stow Center Aisle Hand Rail

Requires no tool and stores on the deck in the bleacher's closed position. Rail rotates and snaps into place.



Self-Storing End Rails

This stylish self-storing rail is designed to meet the most stringent codes for rail loading and sphere passage. Add 12" (305 mm) to bank length for each railed end.

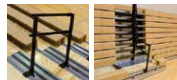

Powerglide™ Automatic Aisle Rails

Maximum safety with minimal effort. Open, the rail provides almost continuous support down the aisle. The rails automatically fold to the closed position as the bank closes.

Other Options



Safety End-Closure Curtains

Prevent unauthorized access to the underside of the bleacher, misuse that can result in injury, vandalism and potential liability risk. With Hussey Safety End-Closure Curtains, you can boost gym security while displaying your school pride. Built school-tough, they work beautifully and securely on new or existing bleachers. And Hussey offers the capability for full-bleed designs—including photographs. When paired with the CourtSide™ graphic logo, you can carry your school's identity throughout the gym.



CourtSide
Graphic Logo



Power Assist

Portable power permits one person to open and close manual sections by moving the tractor from section to section. Operates on standard 115 volt 20 amp service.



Integral Power

MAXAM®'s Powered Frame design applies force where needed—at the frames—and allows for better tracking over uneven floors. With five power options available, you buy only the power you need.



Elevated Front Aisle

Elevated front aisles start at various heights and run the length of the first row of the bleacher. EFA's improve sight lines and are ideal installations for hockey rinks and more. All can be outfitted with front rails, end rails, front panels or access stairs. An ideal solution to facilitate egress and accommodate your individual building requirements. Access stairs can be added as an option.



Aisle Steps

Intermediate steps at each vertical aisle are mounted to the deck providing code-compliant rises and tread depth. Steps are fitted with non-skid strips and offer rounded edges to enhance safety.



Motion Monitor

Audio-visual warning for an integrally powered unit that provides a flashing light with self-contained warning horn. Rated at 85 dB, it activates when bleachers are in motion.



Limit Switch

Limit switches ensure the motor stops once the bank is completely open or closed.

WALL ATTACHED

Our most popular telescopic gym seating solution. Wall attached systems are supplied in 3 to 30 tier banks, are extremely adaptable, and efficiently recover floor space, allowing you to easily get the most out of your facility at all times.

MAXAM™ Telescopic Platform with Metro™ CourtSide™ Seats
Indiana University-Purdue University Fort Wayne • Fort Wayne, IN
Lee Company

REVERSE-FOLD

Often utilized for balcony seating areas, reverse-fold systems retract from back to front to create additional space behind the unit. This space can be used for practice areas, batting cages, volleyball, gymnastics or any wide array of uses. Add back panels for a cleaner look, more versatility and improved safety.

MAXAM™ Telescopic Platform with Upholstered Metro™ Chairs
Grand Prairie Center • Stuttgart, AR
SCM Architects



Wall Attached Closed



Pendant Control
Pendant controls allow the operator to see the entire bank as it opens and closes—an important safety precaution. The pendant control can be easily removed to prevent unauthorized use.



Wireless Remote Control
All of the built-in safety features of our standard pendant control, with the additional convenience and freedom of movement offered by wireless operation.



Reverse-Fold Closed



Reverse-Fold Delayed Action
Further increase your usable space by up to 3' (914 mm) with MAXAM's delayed action feature. The entire closed bleacher stack moves forward on a linkage to recover additional floor space.

RECESSED

This system utilizes a pocket in the wall to house the bleacher when closed. The ends may or may not be exposed, and the bleacher is hidden from view typically under a balcony or mezzanine.

Recessed bleachers are outfitted with upper and lower tracking guides, removable end rails, and can accommodate custom transition steps to the balcony when required.

MAXAM™ Telescopic Platform w/ Metro Chairs
Lake Hamilton High School • Pearcy, AR
SOPA Inc.

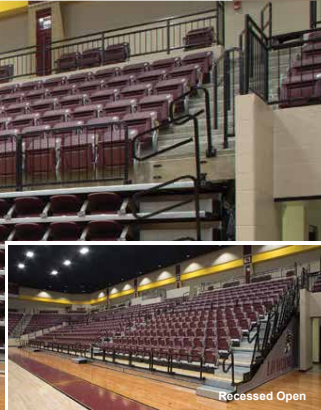

PORTABLE & FREESTANDING

Portable
These bleacher sections allow you to easily move and store bleachers where you want them. Create any number of custom seating layouts for different events. Units may be equipped with locking floor pins for extra safety and security.

Freestanding
With a heavier rear column that's permanently secured to the floor, these bleachers provide design flexibility for buildings that can't support wall loading or where wall loading is marginal.

MAXAM™ Telescopic Bleacher w/ Metro Chairs
Fantasy Springs Resort Casino • Indio, CA
Herk-Edwards, Inc.



Traveling Units



A hybrid of recessed and portable banks, traveling units use integral power to drive the entire bank from one setup position to another. Set-up time is greatly reduced compared to individual portable sections.



Portable Closed

Portable Dolly
Most economical for large number of small portable sections. Two dollies are required to move one section. Maximum section weight of 4000 lbs (1800 kgs).

Integral Dolly
Ideal for high tier units, the integral lifting mechanism allows your staff to move multiple portable sections without additional equipment. Four mechanical screw jacks lift the unit and 12 large wheels allow for effortless transportation of your bleacher. Maximum section weight of 7000 lbs (3150 kgs).

MXP TELESCOPIC PLATFORM

Featuring an amazingly stable and durable telescopic platform that accommodates Hussey's premium seating styles, MXP is expertly engineered for arenas to save time and labor costs while providing the most comfortable and luxurious telescopic platform seating experience available.

MXP Telescopic Platform w/ Metro™ Chairs
Bryce Jordan Center • State College, PA
C.M. Eichenlaub Co.



MXP™ Telescopic Platform w/ Quattro® Chairs
Cross Insurance Center • Bangor, ME
Sink Combs Detblefs



Integrated Program Supports
MXP platforms offer nearly endless customization options for professional arena needs. Adding Integrated Program Supports to an MXP platform allows the section to be truncated at any row. You get the flexibility of choosing how many rows each section needs, on-demand. Engaging this feature is quick and easy with no extra personnel, parts or labor required, and the section is completely stable no matter where it is truncated.

Heavy-Duty Arena Features
MXP platforms focus on delivering on-the-spot configuration flexibility. Completely independent powered sections accommodate nearly any concert configuration easily and change over quickly. Railings can be customized to attach to any row within sections for maximum flexibility and to deliver the crowd control often required by popular tours. Best of all, railings store right on each section to eliminate loose parts and storage hassles.

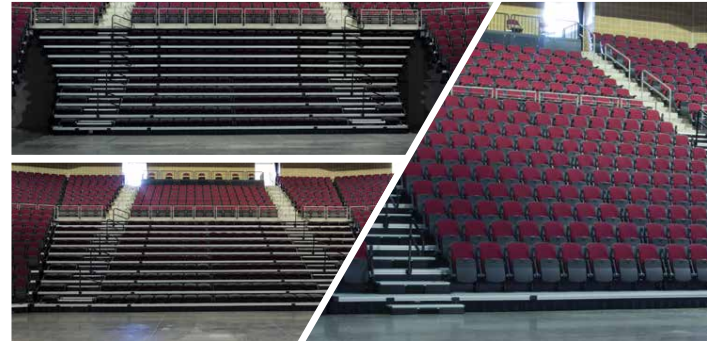

Professional Grade Style, Comfort & Functionality

MXP platforms are designed to support fully upholstered chairs – even premium VIP chairs from our Quattro® Collections.

Accommodating up to a 39 3/4" (1M) premium seat back, your patrons will love the look and feel of MXP. With deeper row spacing, more legroom and our premium upholstered chair options, telescopic seating has never been more comfortable.

Plus, our new chair mounting system delivers the most stable, solid telescopic seating experience available today - one with the feel of a fixed auditorium chair and the flexibility of a telescopic platform.

No matter what chair you choose, it folds flat into the telescopic platform. MXP platforms and the chairs it supports are professional arena grade – designed to withstand the rigors of multiple changeovers a day.

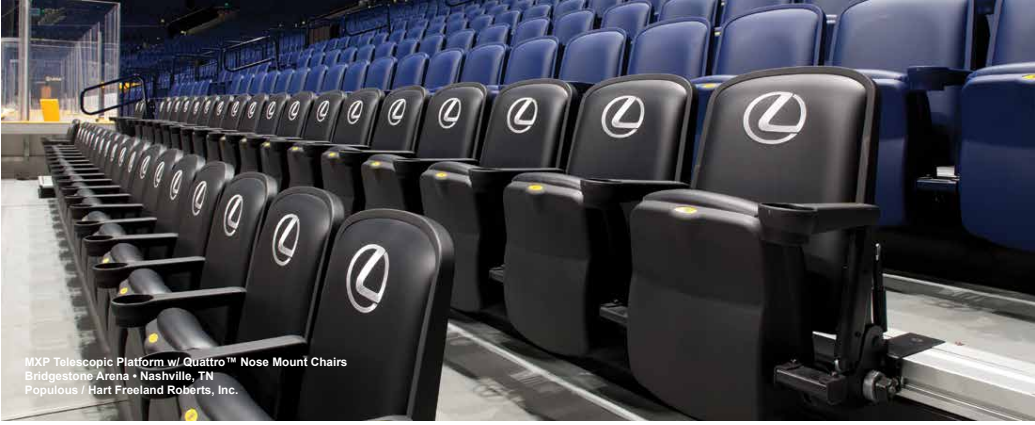

MXP Telescopic Platform w/ Quattro™ Nose Mount Chairs
Bridgestone Arena • Nashville, TN
Populous / Hart Freeland Roberts, Inc.

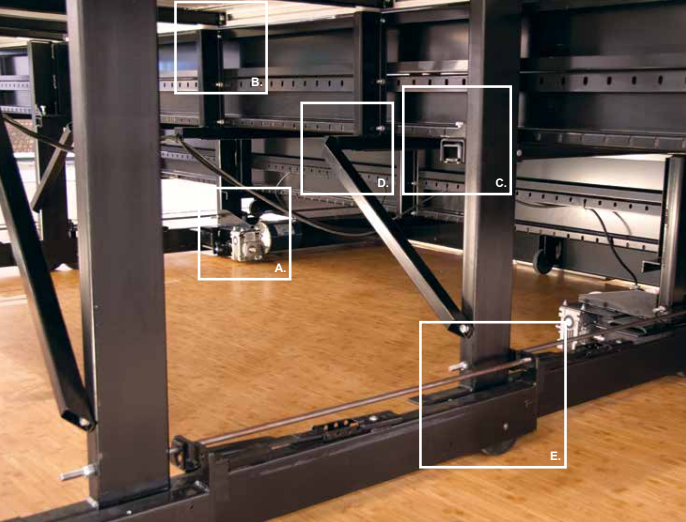

MXP™ Understructure

Flexibility, Safety, Performance & Reliability

The understructure of any telescopic platform is the backbone of the system, and MXP's understructure is engineered to provide maximum flexibility, safety, performance and reliability. Utilizing Hussey's proven vertical frame design, MXP accommodates rises from 4"-24" (102-610 mm), row spacing from 32" - 39 3/8" (813mm - 1M) in 1" (25 mm) increments, and tapered sections up to 22 1/2 degrees, providing maximum seating configuration flexibility.

- A. Soft-Start Steerable Power**
The most efficient system in the industry, our Soft-Start Steerable Power system utilizes existing power sources, has a controlled start to prevent wear and tear on the system and your facility, and allows a single operator to steer the section and fine-tune its final position.
- B. Fully Captive Interlocks**
Providing the ultimate in safety and performance, fully captive upper and lower interlocks ensure the frames can never separate. Plus, the upper interlocks provide a stable, locked deck when loaded so your audience will feel as safe and stable on the 30th row as on the first.
- C. Adjustable Cantilevers**
Creating an exceptionally quiet deck and better overall operational performance, the adjustable cantilevers eliminate friction points during open/close.
- D. Tubular Knee Bracing**
Designed to withstand heavy use and heavy loads, the tubular knee braces provide a safe, rigid walking surface.
- E. Lower Captive Interlocks**
The lower interlock design nests completely, permitting a zero-offset between tiers that minimizes the closed footprint of the system. Pre-tension guide rods cannot be bent or disengaged resulting in smooth, reliable operation every time.

MXP™ Seat Options



Quattro® Nose-Mount Seating
Our Quattro nose-mount chairs can be raised and lowered in pairs, with the armrest locking into place providing an exceptionally solid, stable seat.



Quattro Forward-Fold Seating
Setup and changeover is fast and easy with a single operator by simply unlocking our Quattro forward-fold upholstered chair rows and raising or lowering up to 14 seats at a time.



Metro Semi-Automatic Seating
Our Metro seats can be configured for true semi-automatic operation of up to 14 chairs at once. The chairs automatically lower as the system is closed and when opened, the operator provides a manual assist to lock the chairs into place.



HUSSEY SEATWAY

Hussey Seatway has long established itself as a leader in the design, manufacture and installation of retractable and fixed seating systems. Working with clients in the UK and worldwide, Hussey Seatway is an experts in the development of practical, effective and high-quality seating solutions.

We are a solution and customer orientated company which, backed up with our design expertise enables us to engineer space to our customer's advantage allowing their visions to be achieved.



www.husseyseatway.com

Seatway TP Platforms w/ Gallery 2 Chairs
Kings School • Chester, UK
Child Graddon Lewis Architects



Seatway Seating Options



Club Bench

The Club Bench closes into a small space, allowing for a minimum rise per row of just under 10½" (260 mm). The manual folding, preformed plywood seat and back come with your choice of upholstery. Also available without the backrest.



Arts PC

A premium, nose mounted chair with unique folding action and auto armrests, the Arts PC chair closes down into a small space, allowing a standard row rise of only 10½" (260 mm). Available in a range of chair widths, with high quality finishes and accessories.



Gallery 3

Available in a variety of widths, with or without armrests and in a variety of upholsterys, the Gallery 2 chair features a slim and elegant profile, great for a wide range of auditorium seating.



Metro™ Polymer and Upholstered

Sleek, slim and easy to install, the Metro chair comes in a variety of widths and color options.

Dimensional Data

* See Dimensional Notes below

Number of Rows	MAXAM™ Open Dimensions			MAXAM+ Closed	
	36" Spacing	762 mm Spacing	133" Spacing	133" Spacing	133" Spacing
2	2'-10"	1'-9"	3'-7"	1'-8"	1'-8"
3	4'-4"	3'-0"	5'-1"	3'-11"	3'-11"
4	6'-0"	4'-5"	6'-8"	5'-11"	5'-11"
5	7'-6"	6-0"	8-3"	7'-10"	7'-10"
6	9'-2"	7-6"	9-10"	8'-11"	8'-11"
7	10'-8"	9-2"	10-10"	9'-11"	9'-11"
8	12-4"	10-8"	11-7"	10'-11"	10'-11"
9	14-0"	12-4"	12-7"	11'-11"	11'-11"
10	15-6"	14-0"	14-4"	13'-0"	13'-0"
11	17-2"	15-6"	16-1"	14'-2"	14'-2"
12	18-8"	17-2"	17-8"	15'-3"	15'-3"
13	20-4"	18-8"	19-4"	16'-4"	16'-4"
14	22-0"	20-4"	21-1"	17'-5"	17'-5"
15	23-6"	22-0"	22-8"	18'-6"	18'-6"
16	25-2"	23-6"	24-4"	19'-7"	19'-7"
17	26-8"	25-2"	26-1"	20'-8"	20'-8"
18	28-4"	26-8"	27-8"	21'-9"	21'-9"
19	30-0"	28-4"	29-4"	22'-10"	22'-10"
20	31-6"	30-0"	31-1"	23'-11"	23'-11"
21	33-2"	31-6"	32-8"	24'-11"	24'-11"
22	34-8"	33-2"	34-4"	25'-11"	25'-11"
23	36-4"	34-8"	36-1"	26'-11"	26'-11"
24	38-0"	36-4"	37-8"	27'-11"	27'-11"
25	39-6"	38-0"	39-4"	28'-11"	28'-11"
26	41-2"	39-6"	41-1"	29'-11"	29'-11"
27	42-8"	41-2"	42-8"	30'-11"	30'-11"
28	44-4"	42-8"	44-4"	31'-11"	31'-11"
29	46-0"	44-4"	46-1"	32'-11"	32'-11"
30	47-6"	46-0"	47-8"	33'-11"	33'-11"

* See Dimensional Notes below

Number of Rows	MAXAM+ Overall Seat Height				
	9 1/8" Rise	244 mm Rise	11 5/8" Rise	295 mm Rise	16" Rise
2	2'-2 1/8"	676	2'-4 5/8"	727	2'-0"
3	3'-4 1/8"	821	3'-4 1/8"	1022	4'-1"
4	4'-6 1/8"	1022	4'-6 1/8"	1318	6'-2"
5	5'-8 1/8"	1223	5'-8 1/8"	1613	8'-3"
6	7'-0 1/8"	1424	7'-0 1/8"	1909	10'-4"
7	8'-2 1/8"	1625	8'-2 1/8"	2205	12'-5"
8	9'-4 1/8"	1826	9'-4 1/8"	2499	14'-6"
9	10'-6 1/8"	2027	10'-6 1/8"	2795	16'-7"
10	11'-8 1/8"	2228	11'-8 1/8"	3090	18'-8"
11	13'-0 1/8"	2429	13'-0 1/8"	3385	20'-9"
12	14'-2 1/8"	2630	14'-2 1/8"	3680	22'-10"
13	15'-4 1/8"	2831	15'-4 1/8"	3975	24'-11"
14	16'-6 1/8"	3032	16'-6 1/8"	4270	27'-0"
15	17'-8 1/8"	3233	17'-8 1/8"	4565	29'-1"
16	19'-0 1/8"	3434	19'-0 1/8"	4860	31'-2"
17	20'-2 1/8"	3635	20'-2 1/8"	5155	33'-3"
18	21'-4 1/8"	3836	21'-4 1/8"	5450	35'-4"
19	22'-6 1/8"	4037	22'-6 1/8"	5745	37'-5"
20	23'-8 1/8"	4238	23'-8 1/8"	6040	39'-6"
21	25'-0 1/8"	4439	25'-0 1/8"	6335	41'-7"
22	26'-2 1/8"	4640	26'-2 1/8"	6630	43'-8"
23	27'-4 1/8"	4841	27'-4 1/8"	6925	45'-9"
24	28'-6 1/8"	5042	28'-6 1/8"	7220	48'-0"
25	29'-8 1/8"	5243	29'-8 1/8"	7515	50'-1"
26	31'-0 1/8"	5444	31'-0 1/8"	7810	52'-2"
27	32'-2 1/8"	5645	32'-2 1/8"	8105	54'-3"
28	33'-4 1/8"	5846	33'-4 1/8"	8400	56'-4"
29	34'-6 1/8"	6047	34'-6 1/8"	8695	58'-5"
30	35'-8 1/8"	6248	35'-8 1/8"	8990	60'-6"

* DIMENSIONAL NOTES:

- The Open Dimension of bleacher is increased by the depth of front steps when required to access the aisles on front-loaded seating systems.
 - MAXAM Add: 11 3/4" (298mm) to Open Dimension w/ CourtSide Seats
 - MAXAM+ Add: 1-3 3/4" (400mm) to Open Dimension w/ CourtSide Seats
 - MAXAM+ Add: 1-4 1/2" (419mm) to Open Dimension w/ Chairs
- Open and Closed Dimensions are for wall attached application.
 - For Portable Application Add: 2 1/4" (57mm) to Open and Closed Dimensions
 - For Free Standing Application Add: 2 1/4" (57mm) to Open and Closed Dimensions
 - For Reverse Fold Application Add: 2 1/4" (57mm) to Open Dimension
 - For Reverse Fold Application Add: 2 1/4" (57mm) + Row Spacing to Closed Dimension
 - For Recessed Application Add: 6" (157mm) to Closed Dimension for Minimum Recess Depth
- The Open Dimension of bleacher is increased by the depth of front steps when required to access the aisles on front-loaded seating systems.
 - MAXAM Add: 13" (330mm) to Open Dimension
 - MAXAM+ Add: 1- 4 1/2" (419mm) to Open Dimension
- For Recessed Applications Add: 2 1/4" (64mm) to seat height for minimum recess height.
- The chart above identifies Maximum number of rows for wall attached section lengths 16'-6" (5029mm) or greater.
- SPECIAL NOTE: For complete dimensional charts referring to smaller sections and other applications including product limitations please reference FASTFACTS or ask your local dealer for details.

MXP™ & Hussey Seatway
MXP and Hussey Seatway are customized to your specifications with the following standard dimensions:

MXP
Row Rise: 4 - 24" (102 - 610 mm)
Row Spacing: 32 - 36" (813 - 914 mm)
Tapered Sections: Up to 22½ degrees

Seatway™
Row Rise: 10 1/2" (260 mm), 11" (280 mm), 11 1/4" (300 mm), 12 1/2" (320 mm)
Row Spacing: 33 1/2" (850 mm), 35 1/2" (900 mm), 36" (915 mm)



Restored Hussey Plow Co. Model No. 25, ca 1895
Main Campus • North Berwick, ME
Photo by Ron Bilodeau

Sustainability

At Hussey Seating, respecting the landscape we live in—and the hard work and well-being of the people we work with—has always been in our DNA and part of our heritage. Our commitment to environmentally friendly business practices has taken many forms over the years as standards and technology have changed.



In the 1970s, when the rest of the nation began to become more environmentally aware, we had already laid walking trails and planted a tree farm on our beautiful Maine campus. Today, going green means developing environmentally friendly paints and finishes, sourcing sustainable woods and metals, going beyond local and national regulations in clean manufacturing and waste disposal, and making deliveries on time while reducing our carbon footprint. We reduced our air emissions by 90% while tripling our seating business, so we know green business is good business.

Hussey seating solutions come in a wide range of colors—but every day our seats get greener. If you'd like to learn more about our sustainability efforts, please visit our website at www.husseyseating.com/sustainability

Resources

For all of our Telescopic accessories, surface materials, fast facts, environmental data sheets and more go to HusseySeating.com.

News & Updates

Web: HusseySeating.com
Facebook: facebook.com/HusseySeating
Twitter: twitter.com/husseyseating
YouTube: youtube.com/user/hscpublic
LinkedIn: linkedin.com/company/hussey-seating-company

Warranty

Our factory-backed warranty is the best in the industry.

Interior Warranty
Limited Lifetime: structure
5 years: components

Exterior Warranty
Limited Lifetime: structure
5 years: components
3 years: foam, powder coat finish
1 year: upholstery stitching and thread, polymer finish.

Expert Support

It's standard equipment on every Hussey product.

- Safety Inspections
- Service Contracts
- Accessories
- Custom Fabrication
- Factory-Certified Parts
- Renovation & Repair

Toll-Free (USA) 1.800.353.3308



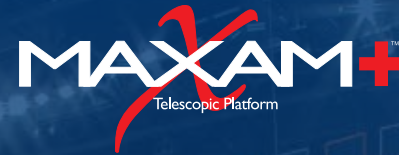

Hussey Seating Company™

The Hussey Seating Company story dates back to 1835 with William Hussey's tremendously successful plow design, and thus, the Hussey Plow Company was born. As times changed over the next sixty years, the family set about reinventing the business, evolving into the company that is now seating the world. Today, under the sixth generation of family leadership, Hussey Seating Company is proud to be known as the leading manufacturer of seating solutions throughout the world – in stadiums, arenas, schools, universities, colleges, places of worship and anywhere people gather.

Your partner for seating solutions.

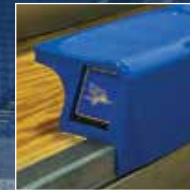

husseyseating™

YOUR PARTNER FOR SEATING SOLUTIONS

38 Dyer Street Extension
North Berwick, Maine 03906 USA
Toll Free (USA) 1.800.341.0401
Tel: +1.207.676.2271
Fax: +1.207.676.2222
info@husseyseating.com
www.husseyseating.com

Regional Offices:
Europe & Middle East
Hussey Seatway
www.husseyseatway.com
Asia-Pacific
Hussey Asia-Pacific
www.husseyasiapacific.com



©2017 Hussey Seating Company. All rights reserved. Hussey Seating™, MAXAM®, MAXAM+™, Clarin®, Metro™, Xtremelogo™, Step-Signs™, CourtSigns™, CourtSides™, Flex-Row™, Posi-Lock™ and Powerglide™ are registered trademarks of Hussey Seating Company.



TILT & ROLL Portable Bleachers

Auxiliary Seating

Sturdisteel Tilt & Roll Portable Bleachers are a unique solution for limited space or unexpected overflow of crowds, providing extra seating for spectators. Engineered to stack neatly against the wall, these rugged units are designed with non-marking rubber pads for tilting, and large swivel casters for the ultimate in portability without damage to floors.



Features:

- 3 or 4 row units
- Aluminum angle frame
- 2 x 12 aluminum seat boards
- 2 x 10 single footboards
- 6" rise with 24" tread
- 30" or less in height
- Non-scarring rubber pads
- All bearing swivel casters
- Tipping arm
- Five Year Limited Warranty

Rows	Length	Net Seats
3	7'-6"	15
3	15'-0"	30
3	21'-0"	42
3	27'-0"	54
4	7'-6"	20
4	15'-0"	40
4	21'-0"	56
4	27'-0"	72



Sturdisteel is a Division of Schultz Industries, Inc.

P.O. Box 2655, Waco, TX 76702-2655

TEL: 254.666.5155

FAX: 254.666.4472

TOLL FREE: 800.433.3116



www.Sturdisteel.com