

# TIPS VENDOR AGREEMENT

## PART 1 ONLY

Between Neutex Advanced Energy Group and  
(Company Name)

### THE INTERLOCAL PURCHASING SYSTEM (TIPS), a Department of Texas Education Service Center Region 8 for **TIPS RFP 210601 Lighting Systems, Parts and Installations PART 1 ONLY**

#### General Information

The Vendor Agreement (“Agreement”) made and entered into by and between The Interlocal Purchasing System (hereinafter “TIPS”) a government cooperative purchasing program authorized by the Region 8 Education Service Center, having its principal place of business at 4845 US Hwy 271 North, Pittsburg, Texas 75686 and the TIPS Vendor. This Agreement consists of the provisions set forth below, including provisions of all attachments referenced herein. In the event of a conflict between the provisions set forth below and those contained in any attachment, the provisions set forth shall control unless otherwise agreed by the parties in writing and by signature and date on the attachment.

A Purchase Order (“PO”), Agreement or Contract is the TIPS Member’s approval providing the authority to proceed with the negotiated delivery order under the Agreement. Special terms and conditions as agreed between the Vendor and TIPS Member should be added as addendums to the Purchase Order, Agreement or Contract. Items such as certificate of insurance, bonding requirements, small or disadvantaged business goals are some, but not all, of the possible addendums.

## Terms and Conditions

#### Freight

All quotes to Members shall provide a line item for cost for freight or shipping regardless if there is a charge or not. If no charge for freight or shipping, indicate by stating “No Charge”, “\$0”, “included in price” or other similar indication. Otherwise, all shipping, freight or delivery charges shall be passed through to the TIPS Member at cost with no markup and said charges shall be agreed by the TIPS Member unless alternative shipping terms are agreed by TIPS as a result of the proposal award.

#### Warranty Conditions

All new supplies equipment and services shall include **manufacturer's minimum standard warranty** unless otherwise agreed to in writing. Vendor shall be legally permitted to sell all products offered for sale to TIPS Members if the offering is included in the Request for Proposal (“RFP”) category. All goods proposed and sold shall be new unless clearly stated in writing.

#### Customer Support

The Vendor shall provide timely and accurate customer support for orders to TIPS Members as agreed by the Parties. Vendors shall respond to such requests within a commercially reasonable time after receipt of

the request. If support and/or training is a line item sold or packaged with a sale, support shall be as agreed with the TIPS Member.

### **Agreements**

Agreements for purchase will normally be put into effect by means of a purchase order(s) executed by authorized agents of the TIPS Member participating government entities, but other means of placing an order may be used at the Member's discretion.

### **Tax exempt status**

Most TIPS Members are tax exempt and the related laws and/or regulations of the controlling jurisdiction(s) of the TIPS Member shall apply.

### **Assignments of Agreements**

No assignment of this Agreement may be made without the prior notification of TIPS. Written approval of TIPS shall not be unreasonably withheld. Payment for delivered goods and services can only be made to the awarded Vendor, Vendor designated reseller or vendor assigned company.

### **Disclosures**

- Vendor and TIPS affirm that he/she, or any authorized employees or agents, has not given, offered to give, nor intends to give at any time hereafter any economic opportunity, future employment, gift, loan, gratuity, special discount, trip, favor or service to a public servant in connection with this Agreement.
- Vendor shall attach, in writing, a complete description of any and all relationships that might be considered a conflict of interest in doing business with the TIPS program.
- The Vendor affirms that, to the best of his/her knowledge, the offer has been arrived at independently, and is submitted without collusion with anyone to obtain information or gain any favoritism that would in any way limit competition or give an unfair advantage over other vendors in the award of this Agreement.

### **Term of Agreement and Renewals**

The Agreement with TIPS is for approximately three (3) years with an option for renewal for an additional one (1) consecutive year. If TIPS offers the renewal extension year, the Vendor will be notified by email to the primary contact of the awarded Vendor and shall be deemed accepted by the Vendor unless the awarded Vendor notifies TIPS of its objection to the additional term. TIPS may or may not exercise the available extension(s) provided in the original solicitation beyond the base three-year term. Whether or not to offer the extension is at the sole discretion of TIPS.

**“Start Date” for Term Calculation Purposes Only:** Regardless of actual award/effective date of Contract, for Agreement “term” calculation purposes only, the Agreement “start date” is the last day of the month that Award Notifications are anticipated as published in the Solicitation

**Example:** *If the anticipated award date published in the Solicitation is May 22, 2020 but extended negotiations delay award until June 27, 2020 The end date of the resulting initial “three-year” term Agreement, (which is subject to an extension(s)) will still be May 31, 2023.*

**“Termination Date”:** The scheduled Agreement “termination date” shall be the last day of the month of the month of the Original Solicitation’s Anticipated Award Date plus three years.

**Example:** *If the original term is approximately three years, and the solicitation provides an anticipated award date of May 22, 2020, the expiration date of the original three-year term shall be May 31, 2023.*

**Extensions:** Any extensions of the original term shall begin on the next day after the day the original term expires.

**Example Following the Previous Example:** *If TIPS offers a one-year extension, the expiration of the extended term shall be May 31, 2024.*

TIPS may offer to extend Vendor Agreements to the fullest extent the original Solicitation permits.

**Automatic Renewal Clauses Incorporated in Awarded Vendor Agreements with TIPS Members Resulting from the Solicitation and with the Vendor Named in this Agreement.**

No Agreement for goods or services with a TIPS Member by the awarded vendor named in this Agreement that results from the solicitation award named in this Agreement, may incorporate an automatic renewal clause that exceeds month to month terms with which the TIPS Member must comply. All renewal terms incorporated in an Agreement by the vendor with the TIPS Member shall only be valid and enforceable when the vendor receives written confirmation by purchase order, executed Agreement or other written instruction issued by the TIPS Member for any renewal period. The purpose of this clause is to avoid a TIPS Member inadvertently renewing an Agreement during a period in which the governing body of the TIPS Member has not properly appropriated and budgeted the funds to satisfy the Agreement renewal. This term is not negotiable and any Agreement between a TIPS Member and a TIPS awarded vendor with an automatic renewal clause that conflicts with these terms is rendered void and unenforceable.

**Shipments**

The Vendor shall ship, deliver or provide ordered products or services within a commercially reasonable time after the receipt of the order from the TIPS Member. If a delay in said delivery is anticipated, the Vendor shall notify TIPS Member as to why delivery is delayed and shall provide an estimated time for completion of the order. TIPS or the requesting entity may cancel the order if estimated delivery time is not acceptable or not as agreed by the parties.

**Invoices**

Each invoice or pay request shall include the TIPS Member’s purchase order number or other identifying designation as provided in the order by the TIPS Member. If applicable, the shipment tracking number or pertinent information for verification of TIPS Member receipt shall be made available upon request.

**Payments**

The TIPS Member will make payments directly to the Vendor, the Vendor Assigned Dealer or as agreed by the Vendor and the TIPS Member after receiving invoice and in compliance with applicable payment statute(s), whichever is the greater time or as otherwise provided by an agreement of the parties.

**Pricing**

Price increases will be honored according to the terms of the solicitation. All pricing submitted to TIPS shall include the participation fee, as provided in the solicitation, to be remitted to TIPS by the Vendor. Vendor will not show adding the fee to the invoice presented to TIPS Member customer.

**Participation Fees and Reporting of Sales to TIPS by Vendor**

The Participation Fee that was published as part of the Solicitation and the fee published is the legally effective fee, along with any fee conditions stated in the Solicitation. Collection of the fees by TIPS is required under Texas Government Code §791.011 Et seq. Fees are due on all TIPS purchases reported by either Vendor or Member. Fees are due to TIPS upon payment by the Member to the Vendor, Reseller or Vendor Assigned Dealer. Vendor, Reseller or Vendor Assigned Dealer agrees that the participation fee is due to TIPS for all Agreement sales immediately upon receipt of payment including partial payment, from the Member Entity and must be paid to TIPS at least on a monthly basis, specifically within 31 calendar days of receipt of payment, if not more frequently, or as otherwise agreed by TIPS in writing and signed by an authorized signatory of TIPS. Thus, when an awarded Vendor, Reseller or Vendor Assigned Dealer receives any amount of payment, even partial payment, for a TIPS sale, the legally effective fee for that amount is immediately due to TIPS from the Vendor and fees due to TIPS should be paid at least on a monthly basis, specifically within 31 calendar days of receipt of payment, if not more frequently.

### **Reporting of Sales to TIPS by Vendor**

Vendor is required to report all sales under the TIPS contract to TIPS. When a public entity initiates a purchase with a TIPS Awarded Vendor, if the Member inquires verbally or in writing whether the Vendor holds a TIPS Contract, it is the duty of the Vendor to verify whether or not the Member is seeking a TIPS purchase. Once verified, the Vendor must include the TIPS Contract number on any communications and related sales documents exchanged with the TIPS Member entity. To report sales, the Vendor must login to the TIPS Vendor Portal online at [https://www.tips-usa.com/vendors\\_form.cfm](https://www.tips-usa.com/vendors_form.cfm) and click on the PO's and Payments tab. Pages 3-7 of the [Vendor Portal User Guide](#) will walk you through the process of reporting sales to TIPS. Please refer to the TIPS [Accounting FAQ's](#) for more information about reporting sales and if you have further questions, contact the Accounting Team at [accounting@tips-usa.com](mailto:accounting@tips-usa.com). The Vendor or vendor assigned dealers are responsible for keeping record of all sales that go through the TIPS Agreement and submitting same to TIPS. Failure to render the participation fee to TIPS shall constitute a breach of this agreement with our parent governmental entity, Texas Education Service Center Region 8, as established by the Texas legislature and shall be grounds for termination of this agreement and any other agreement held with TIPS and possible legal action. Any overpayment of participation fees to TIPS by a Vendor will be refunded to the Vendor within ninety (90) days of receipt of notification if TIPS receives written notification of the overpayment not later than the expiration of six (6) months from the date of overpayment and TIPS determines that the amount was not legally due to TIPS pursuant to this agreement and applicable law. It is the Vendor's responsibility to identify which sales are TIPS Agreement sales and pay the correct participation fee due for TIPS Agreement sales. Any notification of overpayment received by TIPS after the expiration of six (6) months from the date of overpayment will be non-refundable. Region 8 ESC and TIPS reserve the right to extend the six (6) month deadline to notify if approved by the Region 8 ESC Board of Directors. TIPS reserves all rights under the law to collect the fees due. Please contact TIPS at [tips@tips-usa.com](mailto:tips@tips-usa.com) or call (866) 839-8477 if you have questions about paying fees.

### **Indemnity**

The Vendor agrees to indemnify and hold harmless and defend TIPS, TIPS Member(s), officers and employees from and against all claims and suits by third parties for damages, injuries to persons (including death), property damages, losses, and expenses including court costs and reasonable attorney's fees, arising out of, or resulting from, Vendor's performance under this Agreement, including all such causes of action based upon common, constitutional, or statutory law, or based in whole or in part, upon allegations of negligent or intentional acts on the part of the Vendor, its officers, employees, agents, subcontractors, licensees, or invitees. Parties found liable shall pay their proportionate share of damages as agreed by the parties or as ordered by a court of competent jurisdiction over the case. **NO LIMITATION OF LIABILITY FOR DAMAGES FOR PERSONAL INJURY OR PROPERTY DAMAGE ARE PERMITTED OR AGREED BY TIPS/ESC REGION 8.** Per

Texas Education Code §44.032(f), and pursuant to its requirements only, reasonable Attorney's fees are recoverable by the prevailing party in any dispute resulting in litigation.

### **State of Texas Franchise Tax**

By signature hereon, the Vendor hereby certifies that he/she is not currently delinquent in the payment of any franchise taxes owed the State of Texas under Chapter 171, Tax Code.

### **Miscellaneous**

The Vendor acknowledges and agrees that continued participation in TIPS is subject to TIPS sole discretion and that any Vendor may be removed from the participation in the Program at any time with or without cause. Nothing in the Agreement or in any other communication between TIPS and the Vendor may be construed as a guarantee that TIPS or TIPS Members will submit any orders at any time. TIPS reserves the right to request additional proposals for items or services already on Agreement at any time.

### **Purchase Order Pricing/Product Deviation**

If a deviation of pricing/product on a Purchase Order or contract modification occurs between the Vendor and the TIPS Member, TIPS must be notified within five (5) business days of receipt of change order.

### **Termination for Convenience of TIPS Agreement Only**

TIPS reserves the right to terminate this agreement for cause or no cause for convenience with a thirty (30) days prior written notice. Termination for convenience is conditionally required under Federal Regulations 2 CFR part 200 if the customer is using federal funds for the procurement. All purchase orders presented to the Vendor, but not fulfilled by the Vendor, by a TIPS Member prior to the actual termination of this agreement shall be honored at the option of the TIPS Member. The awarded Vendor may terminate the agreement with ninety (90) days prior written notice to TIPS 4845 US Hwy North, Pittsburg, Texas 75686. The vendor will be paid for goods and services delivered prior to the termination provided that the goods and services were delivered in accordance with the terms and conditions of the terminated agreement. This termination clause does not affect the sales agreements executed by the Vendor and the TIPS Member customer pursuant to this agreement. TIPS Members may negotiate a termination for convenience clause that meets the needs of the transaction based on applicable factors, such as funding sources or other needs.

### **TIPS Member Purchasing Procedures**

Usually, purchase orders or their equal are issued by participating TIPS Member to the awarded vendor and should indicate on the order that the purchase is per the applicable TIPS Agreement Number. Orders are typically emailed to TIPS at tipspo@tips-usa.com.

- Awarded Vendor delivers goods/services directly to the participating member.
- Awarded Vendor invoices the participating TIPS Member directly.
- Awarded Vendor receives payment directly from the participating member.
- Fees are due to TIPS upon payment by the Member to the Vendor. Vendor agrees to pay the participation fee to TIPS for all Agreement sales upon receipt of payment including partial payment, from the Member Entity or as otherwise agreed by TIPS in writing and signed by an authorized signatory of TIPS.

### **Licenses**

Awarded Vendor shall maintain, in current status, all federal, state and local licenses, bonds and permits required for the operation of the business conducted by awarded Vendor. Awarded Vendor shall remain reasonably fully informed of and in compliance with all ordinances and regulations pertaining to the lawful

provision of goods or services under the Agreement. TIPS and TIPS Members reserves the right to stop work and/or cancel an order or terminate this or any other sales Agreement of any awarded Vendor whose license(s) required for performance under this Agreement have expired, lapsed, are suspended or terminated subject to a 30-day cure period unless prohibited by applicable statute or regulation.

### **Novation**

If awarded Vendor sells or transfers all assets, rights or the entire portion of the assets or rights required to perform this Agreement, a successor in interest must guarantee to perform all obligations under this Agreement. A simple change of name agreement will not change the Agreement obligations of awarded vendor. TIPS will consider Contract Assignments on a case by case basis. TIPS must be notified within five (5) business days of the transfer of assets or rights.

### **Site Requirements (*only when applicable to service or job*)**

**Cleanup:** When performing work on site at a TIPS Member's property, awarded Vendor shall clean up and remove all debris and rubbish resulting from their work as required or directed by TIPS Member or as agreed by the parties. Upon completion of work, the premises shall be left in good repair and an orderly, neat, clean and unobstructed condition.

**Preparation:** Awarded Vendor shall not begin a project for which TIPS Member has not prepared the site, unless awarded Vendor does the preparation work at no cost, or until TIPS Member includes the cost of site preparation in a purchase order. Site preparation includes, but is not limited to: moving furniture, installing wiring for networks or power, and similar pre-installation requirements.

**Registered sex offender restrictions:** For work to be performed at schools, awarded Vendor agrees that no employee of a subcontractor who has been adjudicated to be a registered sex offender will perform work at any time when students are, or reasonably expected to be, present unless otherwise agreed by the TIPS Member. Awarded Vendor agrees that a violation of this condition shall be considered a material breach and may result in the cancellation of the purchase order at the TIPS Member's discretion. Awarded Vendor must identify any additional costs associated with compliance of this term. If no costs are specified, compliance with this term will be provided at no additional charge. **Safety measures:** Awarded Vendor shall take all reasonable precautions for the safety of employees on the worksite, and shall erect and properly maintain all necessary safeguards for protection of workers and the public. Awarded Vendor shall post warning signs against all hazards created by the operation and work in progress. Proper precautions shall be taken pursuant to state law and standard practices to protect workers, general public and existing structures from injury or damage.

### **Safety Measures**

Awarded Vendor shall take all reasonable precautions for the safety of employees on the worksite, and shall erect and properly maintain all necessary safeguards for protection of workers and the public. Awarded vendor shall post warning signs against all hazards created by the operation and work in progress. Proper precautions shall be taken pursuant to state law and standard practices to protect workers, general public and existing structures from injury or damage.

### **Smoking**

Persons working under Agreement shall adhere to the TIPS Member's or local smoking statutes, codes or policies.

### **Marketing**

Awarded Vendor agrees to allow TIPS to use their name and logo within TIPS website, marketing materials and advertisement subject to any reasonable restrictions provided to TIPS in the Proposal to the

Solicitation. The Vendor may submit an acceptable use directive for Vendor's names and logos with which TIPS agrees to comply. Any use of TIPS name and logo or any form of publicity, inclusive of press release, regarding this Agreement by awarded vendor must have prior approval from TIPS which will not be unreasonably withheld. Request may be made by email to TIPS@TIPS-USA.COM.

### **Supplemental Agreements**

The TIPS Member entity participating in the TIPS Agreement and awarded Vendor may enter into a separate Supplemental Agreement or contract to further define the level of service requirements over and above the minimum defined in this Agreement such as but not limited to, invoice requirements, ordering requirements, specialized delivery, etc. Any Supplemental Agreement or contract developed as a result of this Agreement is exclusively between the TIPS Member entity customer and the Vendor. TIPS, its agents, TIPS Members and employees not a party to the Supplemental Agreement with the TIPS Member customer, shall not be made party to any claim for breach of such agreement unless named and agreed by the Party in question in writing in the agreement. If a Vendor submitting a Proposal requires TIPS and/or TIPS Member to sign an additional agreement, those agreements shall comply with the award made by TIPS to the Vendor. Supplemental Vendor's Agreement documents may not become part of TIPS' Agreement with Vendor unless and until an authorized representative of TIPS reviews and approves it. TIPS review and approval may be at any time during the life of this Vendor Agreement. TIPS permits TIPS Members to negotiate additional terms and conditions with the Vendor for the provision of goods or services under the Vendor's TIPS Agreement so long as they do not materially conflict with this Agreement.

### **Survival Clause**

All applicable sales, leases, Supplemental Agreements, contracts, software license agreements, warranties or service agreements that were entered into between Vendor and TIPS or the TIPS Member Customer under the terms and conditions of this Agreement shall survive the expiration or termination of this Agreement. All Orders, Purchase Orders issued or contracts executed by TIPS or a TIPS Member and accepted by the Vendor prior to the expiration or termination of this agreement, shall survive expiration or termination of the Agreement, subject to previously agreed terms and conditions agreed by the parties or as otherwise specified herein relating to termination of this agreement.

### **Legal obligations**

It is the responding Vendor's responsibility to be aware of and comply with all local, state and federal laws governing the sale of products/services identified in the applicable Solicitation that resulted in this Vendor Agreement and any awarded Agreement thereof. Applicable laws and regulations must be followed even if not specifically identified herein.

### **Audit rights**

Due to transparency statutes and public accountability requirements of TIPS and TIPS Members', the awarded Vendor shall, at their sole expense, maintain appropriate due diligence of all purchases made by TIPS Member that utilizes this Agreement. TIPS and Region 8 ESC each reserve the right to audit the accounting of TIPS related purchases for a period of three (3) years from the time such purchases are made. This audit right shall survive termination of this Agreement for a period of one (1) year from the effective date of termination. In order to ensure and confirm compliance with this agreement, TIPS shall have authority to conduct audits of Awarded Vendor's pricing or TIPS transaction documentation with TIPS Members with 30 days' notice unless the audit is ordered by a Court Order or by a Government Agency with authority to do so without notice. Notwithstanding the foregoing, in the event that TIPS is made aware of any pricing being offered to eligible entities that is materially inconsistent with the pricing under this agreement, TIPS shall have the ability to conduct the audit internally or may engage a third- party auditing

firm to investigate any possible non-compliant conduct or may terminate the Agreement according to the terms of this Agreement. In the event of an audit, the requested materials shall be reasonably provided in the time, format and at the location acceptable to Region 8 ESC or TIPS. TIPS agrees not to perform a random audit the TIPS transaction documentation more than once per calendar year, but reserves the right to audit for just cause or as required by any governmental agency or court with regulatory authority over TIPS or the TIPS Member.

**Force Majeure**

If by reason of Force Majeure, either party hereto shall be rendered unable wholly or in part to carry out its obligations under this Agreement then such party shall give notice and full particulars of Force Majeure in writing to the other party within a reasonable time after occurrence of the event or cause relied upon, and the obligation of the party giving such notice, so far as it is affected by such Force Majeure, shall be suspended during the continuance of the inability then claimed, except as hereinafter provided, but for no longer period, and such party shall endeavor to remove or overcome such inability with all reasonable dispatch.

**Choice of Law**

The Agreement between the Vendor and TIPS/ESC Region 8 and any addenda or other additions resulting from this procurement process, however described, shall be governed by, construed and enforced in accordance with the laws of the State of Texas, regardless of any conflict of laws principles.

**Venue, Jurisdiction and Service of Process**

Any Proceeding arising out of or relating to this procurement process or any contract issued by TIPS resulting from or any contemplated transaction shall be brought in a court of competent jurisdiction in Camp County, Texas and each of the parties irrevocably submits to the exclusive jurisdiction of said court in any such proceeding, waives any objection it may now or hereafter have to venue or to convenience of forum, agrees that all claims in respect of the Proceeding shall be heard and determined only in any such court, and agrees not to bring any proceeding arising out of or relating to this procurement process or any contract resulting from or any contemplated transaction in any other court. The parties agree that either or both of them may file a copy of this paragraph with any court as written evidence of the knowing, voluntary and freely bargained for agreement between the parties irrevocably to waive any objections to venue or to convenience of forum. Process in any Proceeding referred to in the first sentence of this Section may be served on any party anywhere in the world. Venue for any dispute resolution process, other than litigation, between TIPS and the Vendor shall be located in Camp or Titus County, Texas.

**Project Delivery Order Procedures**

The TIPS Member having approved and signed an interlocal agreement, or other TIPS Membership document, may make a request of the awarded Vendor under this Agreement when the TIPS Member desires goods or services awarded to the Vendor. Notification may occur via phone, the web, courier, email, fax, or in person. Upon notification of a pending request, the awarded Vendor shall acknowledge the TIPS Member's request as soon as possible, but must make contact with the TIPS Member within two working days.

**Status of TIPS Members as Related to This Agreement**

TIPS Members stand in the place of TIPS as related to this agreement and have the same access to the proposal information and all related documents. TIPS Members have all the same rights under the awarded Agreement as TIPS.



### **Vendor's Resellers as Related to This Agreement**

Vendor's Named Resellers ("Resellers") under this Agreement shall comply with all terms and conditions of this agreement and all addenda or incorporated documents. All actions related to sales by Authorized Vendor's Resellers under this Agreement are the responsibility of the awarded Vendor. If Resellers fail to report sales to TIPS under your Agreement, the awarded Vendor is responsible for their contractual failures and shall be billed for the fees. The awarded Vendor may then recover the fees from their named reseller.

### **Support Requirements**

If there is a dispute between the awarded Vendor and TIPS Member, TIPS or its representatives may, at TIPS sole discretion, assist in conflict resolution if requested by either party. TIPS, or its representatives, reserves the right to inspect any project and audit the awarded Vendor's TIPS project files, documentation and correspondence related to the requesting TIPS Member's order. If there are confidentiality requirements by either party, TIPS shall comply to the extent permitted by law.

### **Incorporation of Solicitation**

The TIPS Solicitation which resulted in this Vendor Agreement, whether a Request for Proposals, the Request for Competitive Sealed Proposals or Request for Qualifications solicitation, or other, the Vendor's response to same and all associated documents and forms made part of the solicitation process, including any addenda, are hereby incorporated by reference into this Agreement as if copied verbatim.

### **SECTION HEADERS OR TITLES**

THE SECTION HEADERS OR TITLES WITHIN THIS DOCUMENT ARE MERELY GUIDES FOR CONVENIENCE AND ARE NOT FOR CLASSIFICATION OR LIMITING OF THE RESPONSIBILITIES OF THE PARTIES TO THIS DOCUMENT.

### **STATUTORY REQUIREMENTS**

Texas governmental entities are prohibited from doing business with companies that fail to certify to this condition as required by Texas Government Code Sec. 2270.

By executing this agreement, you certify that you are authorized to bind the undersigned Vendor and that your company (1) does not boycott Israel; and (2) will not boycott Israel during the term of the Agreement.

You certify that your company is not listed on and does not and will not do business with companies that are on the Texas Comptroller of Public Accounts list of Designated Foreign Terrorists Organizations per Texas Gov't Code 2270.0153 found at <https://comptroller.texas.gov/purchasing/docs/foreign-terrorist.pdf>

You certify that if the certified statements above become untrue at any time during the life of this Agreement that the Vendor will notify TIPS within three (3) business day of the change by a letter on Vendor's letterhead from and signed by an authorized representative of the Vendor stating the non-compliance decision and the TIPS Agreement number and description at:

Attention: General Counsel  
ESC Region 8/The Interlocal Purchasing System (TIPS)  
4845 Highway 271 North  
Pittsburg, TX,75686  
And by an email sent to [bids@tips-usa.com](mailto:bids@tips-usa.com)

## Insurance Requirements

The undersigned Vendor agrees to maintain the below minimum insurance requirements for TIPS Contract Holders:

<b>General Liability</b>	\$1,000,000 each Occurrence/ Aggregate
<b>Automobile Liability</b>	\$300,000 Includes owned, hired & non-owned
<b>Workers' Compensation</b>	Statutory limits for the jurisdiction in which the Vendor performs under this Agreement.
<b>Umbrella Liability</b>	\$1,000,000

When the Vendor or its subcontractors are liable for any damages or claims, the Vendor's policy, when the Vendor is responsible for the claim, must be primary over any other valid and collectible insurance carried by the Member. Any immunity available to TIPS or TIPS Members shall not be used as a defense by the contractor's insurance policy. The coverages and limits are to be considered minimum requirements and in no way limit the liability of the Vendor(s). Insurance shall be written by a carrier with an A-; VII or better rating in accordance with current A.M. Best Key Rating Guide. Only deductibles applicable to property damage are acceptable, unless proof of retention funds to cover said deductibles is provided. "Claims made" policies will not be accepted. Vendor's required minimum coverage shall not be suspended, voided, cancelled, non-renewed or reduced in coverage or in limits unless replaced by a policy that provides the minimum required coverage except after thirty (30) days prior written notice by certified mail, return receipt requested has been given to TIPS or the TIPS Member if a project or pending delivery of an order is ongoing. Upon request, certified copies of all insurance policies shall be furnished to the TIPS or the TIPS Member.

## Special Terms and Conditions

- **Orders:** All Vendor orders received from TIPS Members must be emailed to TIPS at tipspo@tips-usa.com. Should a TIPS Member send an order directly to the Vendor, it is the Vendor's responsibility to forward a copy of the order to TIPS at the email above within 3 business days and confirm its receipt with TIPS.
- **Vendor Encouraging Members to bypass TIPS agreement:** Encouraging TIPS Members to purchase directly from the Vendor or through another agreement, when the Member has requested using the TIPS cooperative Agreement or price, and thereby bypassing the TIPS Agreement is a violation of the terms and conditions of this Agreement and will result in removal of the Vendor from the TIPS Program.
- **Order Confirmation:** All TIPS Member Agreement orders are approved daily by TIPS and sent to the Vendor. The Vendor should confirm receipt of orders to the TIPS Member (customer) within 3 business days.
- **Vendor custom website for TIPS:** If Vendor is hosting a custom TIPS website, updated pricing when effective. TIPS shall be notified when prices change in accordance with the award.
- **Back Ordered Products:** If product is not expected to ship within the time provided to the TIPS Member by the Vendor, the Member is to be notified within 3 business days and appropriate action taken based on customer request.

The TIPS Vendor Agreement Signature Page is inserted here.

# TIPS Vendor Agreement Signature Form

RFP 210601 Lighting Systems, Parts and Installations PART 1 ONLY

Company Name Neutex Advanced Energy Group

Address 15700 Vickery Dr.

City Houston State TX Zip 77032

Phone 281-253-4509 Fax (281) 227-2209

Email of Authorized Representative Andrea@calyxpure.com

Name of Authorized Representative Andrea Duhon

Title Factory Direct Sales Coordinator

Signature of Authorized Representative *Andrea Duhon*

Date 7/15/21

TIPS Authorized Representative Name David Fitts

Title Executive Director

TIPS Authorized Representative Signature *David Wayne Fitts*

Approved by ESC Region 8 *David Wayne Fitts*

Date 8/25/2021

## **NOTICE TO MEMBERS REGARDING ATTRIBUTE RESPONSES**

TIPS VENDORS RESPOND TO ATTRIBUTE QUESTIONS AS PART OF TIPS COMPETITIVE SOLICITATION PROCESS. THE VENDOR'S RESPONSES TO ATTRIBUTE QUESTIONS ARE INCLUDED HEREIN AS "SUPPLIER RESPONSE." PLEASE BE ADVISED THAT DEVIATIONS, IF ANY, IN VENDOR'S RESPONSE TO ATTRIBUTE QUESTIONS MAY NOT REFLECT VENDOR'S FINAL ATTRIBUTE RESPONSE, WHICH IS SUBJECT TO NEGOTIATIONS PRIOR TO AWARD. PLEASE CONTACT THE TIPS OFFICE AT 866-839-8477 WITH QUESTIONS OR CONCERNS REGARDING VENDOR ATTRIBUTE RESPONSE DEVIATIONS. PLEASE KEEP IN MIND THAT TIPS DOES NOT PROVIDE LEGAL COUNSEL TO MEMBERS. TIPS RECOMMENDS THAT YOU CONSULT YOUR LEGAL COUNSEL WHEN EXECUTING CONTRACTS WITH OR MAKING PURCHASES FROM TIPS VENDORS.



**210601**  
**Neutex Lighting**  
**Neutex Advanced Energy Group Inc.**  
**Supplier Response**

**Event Information**

Number: 210601  
Title: Lighting Systems, Parts, and Installations (2 PART with JOC)  
Type: Request for Proposal  
Issue Date: 6/3/2021  
Deadline: 7/16/2021 03:00 PM (CT)  
Notes: This is a 2 PART solicitation. PART 1 is for projects that are not considered construction or a public work. It includes, but is not limited to, parts, supplies, maintenance services and repairs. PART 2 Job Order Contract (JOC) is for projects considered construction or public work projects. The determination of whether or not a project requires a PART 2 JOC is the responsibility of the TIPS member entity. Vendors are encouraged to respond to BOTH PARTS 1 and 2 to meet the needs of our members, but responses to both parts is not required.

**IF YOU CURRENTLY HOLD TIPS CONTRACT(S) 18060201 Lighting Systems, Parts and Installations (PART 1) AND/OR 18060202 Lighting Systems, Parts and Installations (PART 2), YOU MUST RESPOND TO THIS SOLICITATION TO PREVENT LAPSE OF CONTRACT UNLESS YOU HOLD ANOTHER CURRENT TIPS CONTRACT THAT COVERS ALL OF YOUR LIGHTING OFFERINGS. THIS AWARDED CONTRACT WILL**

**REPLACE YOUR EXPIRING TIPS CONTRACT(S)18060201  
Lighting Systems, Parts and Installations (PART 1)  
AND/OR 18060202 Lighting Systems, Parts and  
Installations (PART 2).**

**Contact Information**

Address: Region 8 Education Service Center  
4845 US Highway 271 North  
Pittsburg, TX 75686  
Phone: +1 (866) 839-8477  
Email: [bids@tips-usa.com](mailto:bids@tips-usa.com)

## Neutex Lighting Information

Address: 15700 Vickery drive  
Houston, TX 77032  
Phone: (281) 227-2208  
Fax: (281) 227-2209  
Web Address: [www.neutexlighting.com](http://www.neutexlighting.com)

By submitting your response, you certify that you are authorized to represent and bind your company.

Andrea Duhon

*Signature*

Submitted at 7/15/2021 3:12:52 PM

[Andrea@calyxpure.com](mailto:Andrea@calyxpure.com)

*Email*

## Requested Attachments

### Agreement Signature Form PART 1 ONLY

NAE-210601 Agreement Signature Form PART 1 ONLY.pdf

If you have not taken exception or deviation to the agreement language in the solicitation attributes, download the AGREEMENT SIGNATURE FORM from the "ATTACHMENTS" tab. This PDF document is a fillable form. Download the document to your computer, fill in the requested company information, print the file, SIGN the form, SCAN the completed and signed AGREEMENT SIGNATURE FORM, and upload here.

If you have taken exception to any of the agreement language and noted the exception in the deviations section of the attributes for the agreement, complete the AGREEMENT SIGNATURE FORM, but DO NOT SIGN until those deviations have been negotiated and resolved with TIPS management. Upload the unsigned form here, because this is a required document.

### Vendor Agreement PART 1 ONLY

NAE- 210601 Vendor Agreement PART 1 ONLY.pdf

The vendor must download the Vendor Agreement from the attachment tab, fill in the requested information and upload the completed agreement.

DO NOT UPLOAD encrypted or password protected files.

### Vendor Agreement PART 2 ONLY

NAE- 210601 Vendor Agreement JOC\_PART 2 ONLY.pdf

If proposing on Part 2, the vendor must download the Vendor Agreement from the attachment tab, fill in the requested information and upload the completed agreement.

DO NOT UPLOAD encrypted or password protected files.

### Agreement Signature Form PART 2 ONLY

NAE- 210601 Agreement Signature Form PART 2 ONLY.pdf

If proposing on Part 2, the vendor must download the Vendor Agreement from the attachment tab, fill in the requested information and upload the completed agreement.

DO NOT UPLOAD encrypted or password protected files.

### Pricing Form 1 PART 1 ONLY

NAE- Pricing form 1 Part 1.xlsx

The vendor must download the PRICING SPREADSHEET SHEET from the attachment tab, fill in the requested information and upload the completed spreadsheet.

DO NOT UPLOAD encrypted or password protected files.

### Pricing Form 2 PART 1 ONLY

NAE- Pricing\_form\_2.xlsx

The vendor must download the PRICING SPREADSHEET SHEET from the attachment tab, fill in the requested information and upload the completed spreadsheet.

DO NOT UPLOAD encrypted or password protected files.

**OPTIONAL - PART 2 - JOC Pricing of Itemized List of RS Means Non-Prepriced Items**

NAE- 210601 PART 2 JOC Pricing of Means Non-Prepriced Items.xlsx

The Vendor may download the optional Pricing of Itemized List of RS Means Non-Prepriced Items form from the attachment tab, fill in the requested information, and upload the completed spreadsheet. DO NOT UPLOAD encrypted or password protected files.

**Reference Form (PARTS 1 & 2)**

NAE- Reference Form (PARTS 1 & 2).xls

Valid Reference Email addresses are REQUIRED on the spreadsheet. The vendor must download the References spreadsheet from the attachment tab, fill in the requested information and upload the completed spreadsheet. DO NOT UPLOAD encrypted or password protected files.

**Proposed Goods and Services**

NAE- Product Catalog.pdf

Please upload one or more documents or sheets describing your offerings, line cards, catalogs, links to offerings OR list links to your offerings that illustrate the catalog of proposed lines of goods and or services you carry and offer under this proposal. It does not have to be exhaustive but should, at a minimum tell us what you are offering. It could be as simple as a sheet with your link to your online catalog of goods and services.

**D/M/WBE Certification OPTIONAL**

No response

D/M/WBE Certification documentation may be scanned and uploaded if you desire to claim your status as one of the identified enterprises. (Disadvantaged Business Enterprise, Minority Business Enterprise and/or Woman Business Enterprise) If vendor has more than one certification scan into one document. (PDF Format ONLY)  
DO NOT UPLOAD encrypted or password protected files.

**Warranty**

NAE- Warranty information.pdf

Warranty information (if applicable) must be scanned and uploaded. (PDF Format ONLY)  
DO NOT UPLOAD encrypted or password protected files.

**Supplementary**

4-12-21 v2 AG EFFICACY AND TEST RESULTS.pdf

Supplementary information can be scanned and uploaded. (Company information, brochures, catalogs, etc.) (PDF Format ONLY)  
DO NOT UPLOAD encrypted or password protected files.

**All Other Certificates**

No response

All Other Certificates (if applicable) must be scanned and uploaded. If vendor has more than one other certification scan into one document. (PDF Format ONLY)  
DO NOT UPLOAD encrypted or password protected files.

**Logo and Other Company Marks**

logo2.jpg

**Conflict of Interest Form CIQ- ONLY REQUIRED IF A CONFLICT EXISTS PER THE INSTRUCTIONS**

No response

ONLY REQUIRED IF A CONFLICT EXISTS PER THE INSTRUCTIONS  
Conflict of Interest Form for Vendors that are required to submit the form. The Conflict of Interest Form is included in the Base documents or can be found at <https://www.tips-usa.com/assets/documents/docs/CIQ.pdf>.

**Certificate of Corporate Offerer - COMPLETE ONLY IF OFFERER IS A CORPORATION**

NAE- CERTIFICATION OF CORPORATE OFFERER FORM.pdf

COMPLETE AND UPLOAD FORM IN ATTACHMENTS SECTION ONLY IF OFFERER IS A CORPORATION

**Lobbying Report Standard Form-LLL, "disclosure Form to Report Lobbying,"**

No response

If you answered "I HAVE Lobbied per above" to attribute #66, please download and complete and upload the Standard Form-LLL, "disclosure Form to Report Lobbying," in the Response attachments section.

**Confidentiality Form**

NAE- 210601 CONFIDENTIALITY CLAIM FORM.pdf

REQUIRED CONFIDENTIALITY FORM. Complete the form according to your company requirements, make any desired attachments and upload to the appropriate section under "Response Attachments" THIS FORM DETERMINES HOW ESC8/TIPS RESPONDS TO LEGAL PUBLIC INFORMATION REQUESTS.



## Bonding Capacity Letter from Surety/Insurance Company

NAE- Bonding letter.doc

REQUIRED IF YOU ARE PROPOSING ON PART 2 -Attach the Bonding Capacity Letter from Surety/Insurance Company. if you do not have one available at time of proposal, attached a letter stating it will be submitted when received to prove bonding capacity. No award can be made until official bonding capacity letter is received by TIPS.

## Current W-9 Tax Form

NAE- W-9 2021.pdf

You are required by TIPS to upload a current W-9 Internal Revenue Service (IRS) Tax Form for your entity. This form will be utilized by TIPS to properly identify your entity.

## Bid Attributes

<b>1</b>	<b>Yes - No</b> Disadvantaged/Minority/Women Business Enterprise - D/M/WBE (Required by some participating governmental entities) Vendor certifies that their firm is a D/M/WBE? Vendor must upload proof of certification to the "Response Attachments" D/M/WBE CERTIFICATES section. <input type="text" value="No"/>
<b>2</b>	<b>Yes - No</b> Historically Underutilized Business - HUB (Required by some participating governmental entities) Vendor certifies that their firm is a HUB as defined by the State of Texas at <a href="https://comptroller.texas.gov/purchasing/vendor/hub/">https://comptroller.texas.gov/purchasing/vendor/hub/</a> or in a HUBZone as defined by the US Small Business Administration at <a href="https://www.sba.gov/offices/headquarters/ohp">https://www.sba.gov/offices/headquarters/ohp</a> Proof of one or both may be submitted. Vendor must upload proof of certification to the "Response Attachments" HUB CERTIFICATES section. <input type="text" value="No"/>
<b>3</b>	<b>Yes - No</b> The Vendor can provide services and/or products to all 50 US States? <input type="text" value="Yes"/>
<b>4</b>	<b>States Served:</b> If answer is NO to question #3, please list which states can be served. (Example: AR, OK, TX) <input type="text" value="No response"/>
<b>5</b>	<b>Company and/or Product Description:</b> This information will appear on the TIPS website in the company profile section, if awarded a TIPS contract. (Limit 750 characters.) <input type="text" value="Neutex Advanced Energy Group manufactures LED lights and fixtures as well as the UV Air Guardian, an antiviral and antimicrobial air purification and ventilation system. We can also offer bulbs, flat panels, linear tubes, parking lot lights, garage and utility lights, flood lights, and high bays. Canopy, par, and can lights, and other specialty lights such as commercial sign lights and rope lights are also available."/>
<b>6</b>	<b>Primary Contact Name</b> Primary Contact Name <input type="text" value="Andrea Duhon"/>
<b>7</b>	<b>Primary Contact Title</b> Primary Contact Title <input type="text" value="Factory Direct Sales Coordinator"/>

8	<b>Primary Contact Email</b> Primary Contact Email <input type="text" value="Andrea@Calyxpure.com"/>
9	<b>Primary Contact Phone</b> Enter 10 digit phone number. (No dashes or extensions) Example: 8668398477 <input type="text" value="2812534509"/>
10	<b>Primary Contact Fax</b> Enter 10 digit phone number. (No dashes or extensions) Example: 8668398477 <input type="text" value="No response"/>
11	<b>Primary Contact Mobile</b> Enter 10 digit phone number. (No dashes or extensions) Example: 8668398477 <input type="text" value="2812534509"/>
12	<b>Secondary Contact Name</b> Secondary Contact Name <input type="text" value="Colby Fitch"/>
13	<b>Secondary Contact Title</b> Secondary Contact Title <input type="text" value="VP of Sales"/>
14	<b>Secondary Contact Email</b> Secondary Contact Email <input type="text" value="Colby@Calyxpure.com"/>
15	<b>Secondary Contact Phone</b> Enter 10 digit phone number. (No dashes or extensions) Example: 8668398477 <input type="text" value="3463547596"/>
16	<b>Secondary Contact Fax</b> Enter 10 digit phone number. (No dashes or extensions) Example: 8668398477 <input type="text" value="No response"/>
17	<b>Secondary Contact Mobile</b> Enter 10 digit phone number. (No dashes or extensions) Example: 8668398477 <input type="text" value="3463547596"/>

<b>1</b> <b>8</b>	<b>Admin Fee Contact Name</b> Admin Fee Contact Name. This person is responsible for paying the admin fee to TIPS. <input type="text" value="Gina Calanni"/>
<b>1</b> <b>9</b>	<b>Admin Fee Contact Email</b> Admin Fee Contact Email <input type="text" value="Gina@Calyxpure.com"/>
<b>2</b> <b>0</b>	<b>Admin Fee Contact Phone</b> Enter 10 digit phone number. (No dashes or extensions) Example: 8668398477 <input type="text" value="5124098512"/>
<b>2</b> <b>1</b>	<b>Purchase Order Contact Name</b> Purchase Order Contact Name. This person is responsible for receiving Purchase Orders from TIPS. <input type="text" value="Andrea Duhon"/>
<b>2</b> <b>2</b>	<b>Purchase Order Contact Email</b> Purchase Order Contact Email <input type="text" value="Andrea@Calyxpure.com"/>
<b>2</b> <b>3</b>	<b>Purchase Order Contact Phone</b> Enter 10 digit phone number. (No dashes or extensions) Example: 8668398477 <input type="text" value="2812534509"/>
<b>2</b> <b>4</b>	<b>Company Website</b> Company Website (Format - www.company.com) <input type="text" value="www.neutexspecs.com"/>
<b>2</b> <b>5</b>	<b>Entity D/B/A's and Assumed Names</b> Please identify all of your entity's assumed names and D/B/A's. Please note that you will be identified publicly by the legal name under which you responded to this solicitation unless you organize otherwise with TIPS after award. <input type="text" value="Neutex Lighting, CalyxPure, illumiPure"/>
<b>2</b> <b>6</b>	<b>Primary Address</b> Primary Address <input type="text" value="15700 Vickery Dr."/>
<b>2</b> <b>7</b>	<b>Primary Address City</b> Primary Address City <input type="text" value="Houston"/>
<b>2</b> <b>8</b>	<b>Primary Address State</b> Primary Address State (2 Digit Abbreviation) <input type="text" value="Texas"/>

29	<b>Primary Address Zip</b>
	Primary Address Zip <input type="text" value="77032"/>

30	<b>Search Words:</b>
	Please list search words to be posted in the TIPS database about your company that TIPS website users might search. Words may be product names, manufacturers, or other words associated with the category of award. <b>YOU MAY NOT LIST NON-CATEGORY ITEMS.</b> (Limit 500 words) (Format: product, paper, construction, manufacturer name, etc.) <input type="text" value="Bulbs, Wall packs, Wall mount, flat panels, linear tubes, T8, UFO, flood lights, high bays, canopy, pars, retrofit, recessed can, UV-C, Air Guardian, Air Purification, Sanitization, Indoor Air Quality, antiviral, antimicrobial ventilation, 405/470, surface disinfection, illumipure, neutex, exit sign, ropelight, Lights, made in America, LED lighting systems, energy efficiency, parking lot lights"/>

31	<b>Do you want TIPS Members to be able to spend Federal grant funds with you if awarded? Is it your intent to be able to sell to our members regardless of the fund source, whether it be local, state or federal?</b>
	Most of our members receive Federal Government grants and they make up a significant portion of their budgets. The members need to know if your company is willing to sell to them when they spend federal budget funds on their purchase. There are attributes that follow that are provisions from the federal regulations in 2 CFR part 200. Your answers will determine if your award will be designated as Federal or Education Department General Administrative Regulations (EDGAR)compliant.  Do you want TIPS Members to be able to spend Federal grant funds with you if awarded and is it your intent to be able to sell to our members regardless of the fund source, whether it be local, state or federal? <input type="text" value="Yes"/>

32	<b>Yes - No</b>
	Certification of Residency - The vendor's ultimate parent company or majority owner:  (A) has its principal place of business in Texas;  OR  (B) employs at least 500 persons in Texas?  This question is required as a data gathering function for information to our members making purchases with awarded vendors. Does not affect scoring with TIPS. <input type="text" value="Yes"/>

33	<b>Company Residence (City)</b>
	Vendor's principal place of business is in the city of? <input type="text" value="Houston"/>

**3**  
**4** **Company Residence (State)**

Vendor's principal place of business is in the state of?

Texas

**3**  
**5** **Discount Offered - CAUTION READ CAREFULLY BECAUSE VENDORS FREQUENTLY MAKE MISTAKES ON THIS ATTRIBUTE QUESTION**

Remember this is a MINIMUM discount percentage so, be sure the discount percentage inserted here can be applied to ANY OFFERING OF GOODS OR SERVICES THROUGH OUT THE LIFE OF THE CONTRACT

CAUTION: BE CERTAIN YOU CAN HONOR THIS MINIMUM DISCOUNT PERCENTAGE ON ANY OFFERED SERVICE OR GOOD NOW OR DURING THE LIFE OF THE CONTRACT.

What is the MINIMUM percentage discount off of any item or service you offer to TIPS Members that is in your regular catalog (as defined in the solicitation specifications document), website, store or shelf pricing or when adding new goods or services to your offerings during the life of the contract? The resulting price of any goods or services Catalog list prices after this discount is applied is a ceiling on your pricing and not a floor because, in order to be more competitive in the individual circumstance, you may offer a larger discount depending on the items or services purchased and the quantity at time of sale.

Must answer with a number between 0% and 100%.

5%

**3**  
**6** **Yes - No**

If awarded on Part 1 of the TIPS Contract, for the duration of the Contract, Vendor agrees to provide catalog pricing, as defined in the solicitation and below, to TIPS upon request for any goods and services offered on PART 1 of the Vendor's TIPS Contract, if any.

"Catalog" means the available list of tangible personal property or services, in the most current listing, regardless of date, during the life of the contract, that takes the form of a catalog, price list, schedule, shelf price or other form that:

- A. is regularly maintained by the manufacturer or Vendor of an item; and
- B. is either published or otherwise available for inspection by a customer during the purchase process;
- C. to which the minimum discount proposed by the proposing Vendor may be applied.

YES

**3**  
**7** **TIPS administration fee**

By submitting a proposal, I agree that all pricing submitted to TIPS shall include the participation fee, as designated in the solicitation or as otherwise agreed in writing and shall be remitted to TIPS by the Vendor or the vendor's named resellers and as agreed in the Vendor agreement. I agree that the fee shall not and will not be added by the vendor as a separate line item on a TIPS member invoice, quote, proposal or any other written communications with the TIPS member.

3  
8

**REQUIRED FOR PART 2 JOC - PRICING OF Regular Hours Coefficient**

**What is your regular hours coefficient for the RS Means Price Book? (FAILURE TO RESPOND PROHIBITS PART 2 JOC EVALUATION)**

Remember that this is a ceiling price proposed. You can discount lower than your proposed contract coefficient, but not higher.

This is one of three pricing questions that are required for consideration for award on this solicitation. Please consider your answer carefully. An explanation of the TIPS scoring of pricing is included in the attachments for your information.

The below is an Example of how pricing model works (not intended to influence your proposed coefficient, you should propose a coefficient that you determine is right for your business):

To propose the exact pricing as the RS Means Unit Price Book, you would insert a 1.0 and to propose a 5% discount for the RS Means Price Book would be a .95 regular hours coefficient and so on.

3  
9

**REQUIRED FOR PART 2 JOC - PRICING OF After Hours Coefficient**

**What is your after hours coefficient for the RS Means Price Book for work performed after normal working hours? (FAILURE TO RESPOND PROHIBITS PART 2 JOC EVALUATION)**

Remember that this is a ceiling price proposed. You can discount to any TIPS Member customer a lower coefficient than your proposed contract coefficient, but not higher.

This is one of three pricing questions that are required for consideration for award on this solicitation. Please consider your answer carefully. An explanation of the TIPS scoring of pricing titled "Pricing Coefficient Instruction" is included in the attachments for your information.

The below is an EXAMPLE of how the pricing model works (It is not intended to influence your proposed coefficient, you should propose a coefficient that you determine is reasonable for your business for the life of the contract): The most common after hours coefficient is time and a half of the RS Means Unit Price Book prices. To illustrate this coefficient, if your regular hours coefficient is .95, your after hours coefficient would be 1.45.

4  
0

**REQUIRED FOR 2 PART JOC - PRICING for Markup of Non-Prepriced Items in RS Means Unit Price Book**

**What is your proposed Markup Percentage on materials not found in the RS Means Price Book? (FAILURE TO RESPOND PROHIBITS PART 2 JOC EVALUATION)**

If any materials being utilized for a project cannot be found in the RS Means Price Book, this question is what is the markup percentage on those materials?

When answering this question please insert the number that represents your percentage of proposed markup. Example: if you are proposing a 30 percent markup, please insert the number "30".

Remember that this is a ceiling markup. You may markup a lesser percentage to the TIPS Member customer when pricing the project, but not a greater percentage.

EXAMPLE: You need special materials that are not in the RS Means Unit Price Book for a project. You would buy the materials and mark them up to the TIPS Member customer by the percentage you propose in this question. If the materials cost you, the contractor, \$100 and you proposed a markup on this question for the material of 30 percent, then you would charge the TIPS Member customer \$130 for the materials.

4 1	<p><b>Yes - No</b></p> <p>Vendor agrees to remit to TIPS the required administration fee or, if resellers are named, guarantee the fee remittance by or for the reseller named by the vendor?</p> <p>TIPS/ESC Region 8 is required by Texas Government Code § 791 to be compensated for its work and thus, failure to agree shall render your response void and it will not be considered.</p> <p><input type="text" value="Agreed"/></p>
--------	---

4 2	<p><b>Yes - No</b></p> <p>Do you offer additional discounts to TIPS members for large order quantities or large scope of work?</p> <p><input type="text" value="Yes"/></p>
--------	--

4 3	<p><b>Years experience in this category of goods or services.</b></p> <p>Company years experience in this category of goods or services?</p> <p><input type="text" value="0.5"/></p>
--------	--

4 4	<p><b>Resellers:</b></p> <p>Does the vendor have resellers that it will name under this contract?</p> <p>Resellers are defined as other companies that sell your products under an agreement with you, as the awarded vendor of TIPS.</p> <p>EXAMPLE: BIGmart is a reseller of ACME brand televisions. If ACME were a TIPS awarded vendor, then ACME would list BIGmart as a reseller.</p> <p>(If applicable, Vendor should add all Authorized Resellers within the TIPS Vendor Portal upon award).</p> <p><input type="text" value="Yes"/></p>
--------	---

4 5	<p><b>Right of Refusal</b></p> <p>Does the proposing vendor wish to reserve the right not to perform under the awarded agreement with a TIPS member at vendor's discretion?</p> <p><input type="text" value="Yes"/></p>
--------	---

**4** **NON-COLLUSIVE BIDDING CERTIFICATE**

**6** By submission of this bid or proposal, the Bidder certifies that:

- 1) This bid or proposal has been independently arrived at without collusion with any other Bidder or with any Competitor;
- 2) This bid or proposal has not been knowingly disclosed and will not be knowingly disclosed, prior to the opening of bids, or proposals for this project, to any other Bidder, Competitor or potential competitor:
- 3) No attempt has been or will be made to induce any other person, partnership or corporation to submit or not to submit a bid or proposal;
- 4) The person signing this bid or proposal certifies that he has fully informed himself regarding the accuracy of the statements contained in this certification, and under the penalties being applicable to the Bidder as well as to the person signing in its behalf.

Not a negotiable term. Failure to agree will render your proposal non-responsive and it will not be considered.

**4** **CONFLICT OF INTEREST QUESTIONNAIRE - FORM CIQ -Do you have any CONFLICT OF INTEREST TO REPORT OR DISCLOSE under this statutory requirement?**

**7** Do you have any CONFLICT OF INTEREST TO REPORT OR DISCLOSE under this statutory requirement? YES or NO

If you have a conflict of interest as described in this form or the Local Government Code Chapter 176, cited therein- you are required to complete and file with TIPS.  
The Form CIQ is one of the attachments to this solicitation.

There is an optional upload for this form provided if you have a conflict and must file the form

**4** **Filing of Form CIQ**

**8** If yes (above), have you filed a form CIQ by uploading the form to this RFP as directed above?

**4** **Regulatory Standing**

**9** I certify to TIPS for the proposal attached that my company is in good standing with all governmental agencies Federal or state that regulate any part of our business operations. If not, please explain in the next attribute question.

**5** **Regulatory Standing**

**0** Regulatory Standing explanation of no answer on previous question.



**Antitrust Certification Statements (Tex. Government Code § 2155.005)**

By submission of this bid or proposal, the Bidder certifies that:

I affirm under penalty of perjury of the laws of the State of Texas that:

(1) I am duly authorized to execute this contract on my own behalf or on behalf of the company, corporation, firm, partnership or individual (Company) listed below;

(2) In connection with this bid, neither I nor any representative of the Company has violated any provision of the Texas Free Enterprise and Antitrust Act, Tex. Bus. & Comm. Code Chapter 15;

(3) In connection with this bid, neither I nor any representative of the Company has violated any federal antitrust law;

(4) Neither I nor any representative of the Company has directly or indirectly communicated any of the contents of this bid to a competitor of the Company or any other company, corporation, firm, partnership or individual engaged in the same line of business as the Company.

## Suspension or Debarment Instructions

### Instructions for Certification:

1. By answering yes to the next Attribute question below, the vendor and prospective lower tier participant is providing the certification set out herein in accordance with these instructions.
2. The certification in this clause is a material representation of fact upon which reliance was placed when this transaction was entered into. If it is later determined that the prospective lower tier participant knowingly rendered an erroneous certification in addition to other remedies available to the federal government, the department or agency with which this transaction originated may pursue available remedies, including suspension and / or debarment.
3. The prospective lower tier participant shall provide immediate written notice to the person to which this proposal is submitted if at any time the prospective lower tier participant learns that its certification was erroneous when submitted or has become erroneous by reason of changed circumstances.
4. The terms "covered transaction," "debarred," "suspended," "ineligible," "lower tier covered transaction," "participants," "person," "primary covered transaction," "principal," "proposal" and "voluntarily excluded," as used in this clause, have the meanings set out in the Definitions and Coverage sections of rules implementing Executive Order 12549. You may contact the person to which this proposal is submitted for assistance in obtaining a copy of those regulations.
5. The prospective lower tier participant agrees by submitting this form that, should the proposed covered transaction be entered into, it shall not knowingly enter into any lower tier covered transaction with a person who is debarred, suspended, declared ineligible or voluntarily excluded from participation in this covered transaction, unless authorized by the department or agency with which this transaction originated.
6. The prospective lower tier participant further agrees by submitting this form that it will include this clause titled "Certification Regarding Debarment, Suspension, Ineligibility and Voluntary Exclusion-Lower Tier Covered Transaction" without modification in all lower tier covered transactions and in all solicitations for lower tier covered transactions.
7. A participant in a covered transaction may rely upon a certification of a prospective participant in a lower tier covered transaction that it is not debarred, suspended, ineligible or voluntarily excluded from the covered transaction, unless it knows that the certification is erroneous. A participant may decide the method and frequency by which it determines the eligibility of its principals. Each participant may, but is not required to, check the Nonprocurement List.
8. Nothing contained in the foregoing shall be construed to require establishment of a system of records in order to render in good faith the certification required by this clause. The knowledge and information of a participant is not required to exceed that which is normally possessed by a prudent person in the ordinary course of business dealings.
9. Except for transactions authorized under paragraph 5 of these instructions, if a participant in a covered transaction knowingly enters into a lower tier covered transaction with a person who is suspended, debarred, ineligible or voluntarily excluded from participation in this transaction, in addition to other remedies available to the federal government, the department or agency with which this transaction originated may pursue available remedies, including suspension and / or debarment.

5  
3

### Suspension or Debarment Certification

By answering yes, you certify that no federal suspension or debarment is in place, which would preclude receiving a federally funded contract as described above.

Debarment and Suspension (Executive Orders 12549 and 12689)—A contract award (see 2 CFR 180.220) must not be made to parties listed on the government-wide exclusions in the System for Award Management (SAM), in accordance with the OMB guidelines at 2 CFR 180 that implement Executive Orders 12549 (3 CFR part 1986 Comp., p. 189) and 12689 (3 CFR part 1989 Comp., p. 235), "Debarment and Suspension." SAM Exclusions contains the names of parties debarred, suspended, or otherwise excluded by agencies, as well as parties declared ineligible under statutory or regulatory authority other than Executive Order 12549.

By answering yes, you certify that no federal suspension or debarment is in place, which would preclude receiving a federally funded contract as described above.

5  
4

### Non-Discrimination Statement and Certification

In accordance with Federal civil rights law, all U.S. Departments, including the U.S. Department of Agriculture (USDA) civil rights regulations and policies, the USDA, its Agencies, offices, and employees, and institutions participating in or administering USDA programs are prohibited from discriminating based on race, color, national origin, religion, sex, gender identity (including gender expression), sexual orientation, disability, age, marital status, family/parental status, income derived from a public assistance program, political beliefs, or reprisal or retaliation for prior civil rights activity, in any program or activity conducted or funded by USDA (not all bases apply to all programs). Remedies and complaint filing deadlines vary by program or incident.

Persons with disabilities who require alternative means of communication for program information (e.g., Braille, large print, audiotape, American Sign Language, etc.) should contact the responsible Agency or USDA's TARGET Center at (202) 720-2600 (voice and TTY) or contact USDA through the Federal Relay Service at (800) 877-8339. Additionally, program information may be made available in languages other than English.

To file a program discrimination complaint, complete the USDA Program Discrimination Complaint Form, AD-3027, found online at [How to File a Program Discrimination Complaint](#) and at any USDA office or write a letter addressed to USDA and provide in the letter all of the information requested in the form. To request a copy of the complaint form, call (866) 632-9992. Submit your completed form or letter to USDA by: (1) mail: U.S. Department of Agriculture, Office of the Assistant Secretary for Civil Rights, 1400 Independence Avenue, SW, Washington, D.C. 20250-9410; (2) fax: (202) 690-7442; or (3) email: [program.intake@usda.gov](mailto:program.intake@usda.gov).

(Title VI of the Education Amendments of 1972; Section 504 of the Rehabilitation Act of 1973; the Age Discrimination Act of 1975; Title 7 CFR Parts 15, 15a, and 15b; the Americans with Disabilities Act; and FNS Instruction 113-1, Civil Rights Compliance and Enforcement – Nutrition Programs and Activities)

All U.S. Departments, including the USDA are equal opportunity provider, employer, and lender.

Not a negotiable term. Failure to agree will render your proposal non-responsive and it will not be considered. I certify that in the performance of a contract with TIPS or its members, that our company will conform to the foregoing anti-discrimination statement and comply with the cited and all other applicable laws and regulations.

Yes, I certify (Yes)

**5 2 CFR PART 200 Contract Provisions Explanation**

Required Federal contract provisions of Federal Regulations for Contracts for contracts with ESC Region 8 and TIPS Members:

The following provisions are required to be in place and agreed if the procurement is funded in any part with federal funds.

The ESC Region 8 and TIPS Members are the subgrantee or Subrecipient by definition. Most of the provisions are located in 2 CFR PART 200 - Appendix II to Part 200—Contract Provisions for Non-Federal Entity Contracts Under Federal Awards at 2 CFR PART 200. Others are included within 2 CFR part 200 et al.

In addition to other provisions required by the Federal agency or non-Federal entity, all contracts made by the non-Federal entity under the Federal award must contain provisions covering the following, as applicable.

**5 2 CFR PART 200 Contracts**

Contracts for more than the simplified acquisition threshold currently set at \$250,000, which is the inflation adjusted amount determined by the Civilian Agency Acquisition Council and the Defense Acquisition Regulations Council (Councils) as authorized by 41 U.S.C. 1908, must address administrative, contractual, or legal remedies in instances where contractors violate or breach contract terms, and provide for such sanctions and penalties as appropriate.

Notice: Pursuant to the above, when federal funds are expended by ESC Region 8 and TIPS Members, ESC Region 8 and TIPS Members reserves all rights and privileges under the applicable laws and regulations with respect to this procurement in the event of breach of contract by either party.

Does vendor agree?

**5 2 CFR PART 200 Termination**

Termination for cause and for convenience by the grantee or subgrantee including the manner by which it will be effected and the basis for settlement. (All contracts in excess of \$10,000)

Pursuant to the above, when federal funds are expended by ESC Region 8 and TIPS Members, ESC Region 8 and TIPS Members reserves the right to terminate any agreement in excess of \$10,000 resulting from this procurement process for cause after giving the vendor an appropriate opportunity and up to 30 days, to cure the causal breach of terms and conditions. ESC Region 8 and TIPS Members reserves the right to terminate any agreement in excess of \$10,000 resulting from this procurement process for convenience with 30 days notice in writing to the awarded vendor. The vendor would be compensated for work performed and goods procured as of the termination date if for convenience of the ESC Region 8 and TIPS Members. Any award under this procurement process is not exclusive and the ESC Region 8 and TIPS reserves the right to purchase goods and services from other vendors when it is in the best interest of the ESC Region 8 and TIPS.

Does vendor agree?

5  
8

### 2 CFR PART 200 Clean Air Act

Clean Air Act (42 U.S.C. 7401-7671q.) and the Federal Water Pollution Control Act (33 U.S.C. 1251-1387), as amended—Contracts and subgrants of amounts in excess of \$250,000 must contain a provision that requires the non-Federal award to agree to comply with all applicable standards, orders or regulations issued pursuant to the Clean Air Act (42 U.S.C. 7401-7671q) and the Federal Water Pollution Control Act as amended (33 U.S.C. 1251-1387). Violations must be reported to the Federal awarding agency and the Regional Office of the Environmental Protection Agency (EPA).

Pursuant to the Clean Air Act, et al above, when federal funds are expended by ESC Region 8 and TIPS Members, ESC Region 8 and TIPS Members requires that the proposer certify that during the term of an award by the ESC Region 8 and TIPS Members resulting from this procurement process the vendor agrees to comply with all of the above regulations, including all of the terms listed and referenced therein.

Does vendor agree?

5  
9

### 2 CFR PART 200 Byrd Anti-Lobbying Amendment

Byrd Anti-Lobbying Amendment (31 U.S.C. 1352)—Contractors that apply or bid for an award exceeding \$100,000 must file the required certification. Each tier certifies to the tier above that it will not and has not used Federal appropriated funds to pay any person or organization for influencing or attempting to influence an officer or employee of any agency, a member of Congress, officer or employee of Congress, or an employee of a member of Congress in connection with obtaining any Federal contract, grant or any other award covered by 31 U.S.C. 1352. Each tier must also disclose any lobbying with non-Federal funds that takes place in connection with obtaining any Federal award. Such disclosures are forwarded from tier to tier up to the non-Federal award.

Pursuant to the above, when federal funds are expended by ESC Region 8 and TIPS Members, ESC Region 8 and TIPS Members requires the proposer certify that during the term and during the life of any contract with ESC Region 8 and TIPS Members resulting from this procurement process the vendor certifies to the terms included or referenced herein.

Does vendor agree?

6  
0

### 2 CFR PART 200 Federal Rule

Compliance with all applicable standards, orders, or requirements issued under section 306 of the Clean Air Act (42 U.S.C. 1857(h)), section 508 of the Clean Water Act (33 U.S.C. 1368), Executive Order 11738, and Environmental Protection Agency regulations (40 CFR part 15). (Contracts, subcontracts, and subgrants of amounts in excess of \$250,000)

Pursuant to the above, when federal funds are expended by ESC Region 8 and TIPS Members, ESC Region 8 and TIPS Members requires the proposer certify that in performance of the contracts, subcontracts, and subgrants of amounts in excess of \$250,000, the vendor will be in compliance with all applicable standards, orders, or requirements issued under section 306 of the Clean Air Act (42 U.S.C. 1857(h)), section 508 of the Clean Water Act (33 U.S.C. 1368), Executive Order 11738, and Environmental Protection Agency regulations (40 CFR part 15).

Does vendor certify that it is in compliance with the Clean Air Act?

**6** **2 CFR PART 200 Procurement of Recovered Materials**

**1**

A non-Federal entity that is a state agency or agency of a political subdivision of a state and its contractors must comply with section 6002 of the Solid Waste Disposal Act, as amended by the Resource Conservation and Recovery Act. The requirements of Section 6002 include procuring only items designated in guidelines of the Environmental Protection Agency (EPA) at 40 CFR part 247 that contain the highest percentage of recovered materials practicable, consistent with maintaining a satisfactory level of competition, where the purchase price of the item exceeds \$10,000 or the value of the quantity acquired during the preceding fiscal year exceeded \$10,000; procuring solid waste management services in a manner that maximizes energy and resource recovery; and establishing an affirmative procurement program for procurement of recovered materials identified in the EPA guidelines.

Does vendor certify that it is in compliance with the Solid Waste Disposal Act as described above?

**6** **2 CFR PART 200 Rights to Inventions**

**2**

If the Federal award meets the definition of "funding agreement" under 37 CFR §401.2 (a) and the recipient or subrecipient wishes to enter into a contract with a small business firm or nonprofit organization regarding the substitution of parties, assignment or performance of experimental, developmental, or research work under that "funding agreement," the recipient or subrecipient must comply with the requirements of 37 CFR Part 401, "Rights to Inventions Made by Nonprofit Organizations and Small Business Firms Under Government Grants, Contracts and Cooperative Agreements," and any implementing regulations issued by the awarding agency.

Pursuant to the above, when the foregoing applies to ESC Region 8 and TIPS Members, Vendor certifies that during the term of an award resulting from this procurement process, Vendor agrees to comply with all applicable requirements as referenced in the Federal rule above.

Does vendor agree?

**6** **2 CFR PART 200 Domestic Preferences for Procurements**

**3**

As appropriate and to the extent consistent with law, the non-Federal entity should, to the greatest extent practicable under a Federal award, provide a preference for the purchase, acquisition, or use of goods, products, or materials produced in the United States (including but not limited to iron, aluminum, steel, cement, and other manufactured products). The requirements of this section must be included in all subawards including all contracts and purchase orders for work or products under this award. For purposes of 2 CFR Part 200.322, "Produced in the United States" means, for iron and steel products, that all manufacturing processes, from the initial melting stage through the application of coatings, occurred in the United States. Moreover, for purposes of 2 CFR Part 200.322, "Manufactured products" means items and construction materials composed in whole or in part of non-ferrous metals such as aluminum, plastics and polymer-based products such as polyvinyl chloride pipe, aggregates such as concrete, glass, including optical fiber, and lumber.

Pursuant to the above, when federal funds are expended by ESC Region 8 and TIPS Members, Vendor certifies that to the greatest extent practicable Vendor will provide a preference for the purchase, acquisition, or use of goods, products, or materials produced in the United States (including but not limited to iron, aluminum, steel, cement, and other manufactured products).

Does vendor agree?

**6 4 2 CFR PART 200 Ban on Foreign Telecommunications**

Federal grant funds may not be used to purchase equipment, services, or systems that use “covered telecommunications” equipment or services as a substantial or essential component of any system, or as critical technology as part of any system. “Covered telecommunications” means purchases from Huawei Technologies Company or ZTE Corporation (or any subsidiary or affiliate of such entities), and video surveillance and telecommunications equipment produced by Hytera Communications Corporation, Hangzhou Hikvision Digital Technology Company, or Dahua Technology Company (or any subsidiary or affiliate of such entities).

Pursuant to the above, when federal funds are expended by ESC Region 8 and TIPS Members, Vendor certifies that Vendor will not purchase equipment, services, or systems that use “covered telecommunications”, as defined by 2 CFR §200.216 equipment or services as a substantial or essential component of any system, or as critical technology as part of any system.

Does vendor agree?

**6 5 2 CFR PART 200 Equal Employment Opportunity**

Except as otherwise provided under 41 CFR Part 60, all contracts that meet the definition of “federally assisted construction contract” in 41 CFR Part 60-1.3 must include the equal opportunity clause provided under 41 CFR 60-1.4(b), in accordance with Executive Order 11246, “Equal Employment Opportunity” (30 FR 12319, 12935, 3 CFR Part, 1964-1965 Comp., p. 339), as amended by Executive Order 11375, “Amending Executive Order 11246 Relating to Equal Employment Opportunity,” and implementing regulations at 41 CFR part 60, “Office of Federal Contract Compliance Programs, Equal Employment Opportunity, Department of Labor.”

Pursuant to the above, when federal funds are expended by ESC Region 8 and TIPS Members on any federally assisted construction contract, the equal opportunity clause is incorporated by reference herein.

Does vendor agree?

**6 6 2 CFR PART 200 Contract Work Hours and Safety Standards Act (40 U.S.C. 3701-3708)**

*[Applicable ONLY to contracts in excess of \$100,000 involving mechanics or laborers.]* Contract Work Hours and Safety Standards Act (40 U.S.C. 3701-3708). Where applicable, all contracts awarded by the non-Federal entity in excess of \$100,000 that involve the employment of mechanics or laborers must include a provision for compliance with 40 U.S.C. 3702 and 3704, as supplemented by Department of Labor regulations (29 CFR Part 5). Under 40 U.S.C. 3702 of the Act, each contractor must be required to compute the wages of every mechanic and laborer on the basis of a standard work week of 40 hours. Work in excess of the standard work week is permissible provided that the worker is compensated at a rate of not less than one and a half times the basic rate of pay for all hours worked in excess of 40 hours in the work week. The requirements of 40 U.S.C. 3704 are applicable to construction work and provide that no laborer or mechanic must be required to work in surroundings or under working conditions which are unsanitary, hazardous or dangerous. These requirements do not apply to the purchases of supplies or materials or articles ordinarily available on the open market, or contracts for transportation or transmission of intelligence.

Pursuant to the above, when federal funds are expended by ESC Region 8 and TIPS Members on qualifying contracts, Vendor certifies that Vendor will be in compliance with all applicable provisions of the Contract Work Hours and Safety Standards Act during the term of an award for all contracts by the District resulting from this procurement process.

Does vendor agree?

**6**  
**7** **Certification Regarding Lobbying**

Applicable to Grants, Subgrants, Cooperative Agreements, and Contracts Exceeding \$100,000 in Federal Funds

Submission of this certification is a prerequisite for making or entering into this transaction and is imposed by section 1352, Title 31, U.S. Code. This certification is a material representation of fact upon which reliance was placed when this transaction was made or entered into. Any person who fails to file the required certification shall be subject to a civil penalty of not less than \$10,000 and not more than \$100,000 for each such failure.

The undersigned certifies, to the best of his or her knowledge and belief, that:

(1) No Federal appropriated funds have been paid or will be paid by or on behalf of the undersigned, to any person for influencing or attempting to influence an officer or employee of any agency, a Member of Congress, an officer or employee of congress, or an employee of a Member of Congress in connection with the awarding of a Federal contract, the making of a Federal grant, the making of a Federal loan, the entering into a cooperative agreement, and the extension, continuation, renewal, amendment, or modification of a Federal contract, grant, loan, or cooperative agreement.

(2) If any funds other than Federal appropriated funds have been paid or will be paid to any person for influencing or attempting to influence an officer or employee of any agency, a Member of Congress, an officer or employee of congress, or an employee of a Member of Congress in connection with this Federal grant or cooperative agreement, the undersigned shall complete and submit Standard Form-LLL, "disclosure Form to Report Lobbying," in accordance with its instructions.

(3) The undersigned shall require that the language of this certification be included in the award documents for all covered subawards exceeding \$100,000 in Federal funds at all appropriate tiers and that all subrecipients shall certify and disclose accordingly.

**6**  
**8** **Lobbying Report Standard Form-LLL, "disclosure Form to Report Lobbying,"**

ONLY IF you answered "I HAVE Lobbied per above" to attribute above titled "[Certification Regarding Lobbying](#)", please download and complete and upload the Standard Form-LLL, "disclosure Form to Report Lobbying," in the Response attachments section.

**6**  
**9** **Subcontracting with small and minority businesses, women's business enterprises, and labor surplus area firms.**

Do you ever anticipate the possibility of subcontracting any of your work under this award if you are successful?

IF NO, DO NOT ANSWER THE NEXT ATTRIBUTE QUESTION. . IF YES, and ONLY IF YES, you must answer the next question YES if you want a TIPS Member to be authorized to spend Federal Grant Funds for Procurement.



7  
0

**ONLY IF YES TO THE PREVIOUS QUESTION OR if you ever do subcontract any part of your performance under the TIPS Agreement, do you agree to comply with the following federal requirements?**

ONLY IF YES TO THE ABOVE QUESTIONS OR if you ever do subcontract any part of your performance under the TIPS Agreement,

do you agree to comply with the following federal requirements?

Federal Regulation 2 CFR §200.321 Contracting with small and minority businesses, women's business enterprises, and labor surplus area firms. (a)The non-Federal entity must take all necessary affirmative steps to assure that minority businesses, women's business enterprises, and labor surplus area firms are used when possible.

(b) Affirmative steps must include:(1) Placing qualified small and minority businesses and women's business enterprises on solicitation lists;

(2) Assuring that small and minority businesses, and women's business enterprises are solicited whenever they are potential sources;

(3) Dividing total requirements, when economically feasible, into smaller tasks or quantities to permit maximum participation by small and minority businesses, and women's business enterprises;

(4) Establishing delivery schedules, where the requirement permits, which encourage participation by small and minority businesses, and women's business enterprises;

(5) Using the services and assistance, as appropriate, of such organizations as the Small Business Administration and the Minority Business Development Agency of the Department of Commerce ; and

(6) Requiring the prime contractor, if subcontracts are to be let, to take the affirmative steps listed in paragraphs(1) through (5) of this section.

7  
1

**If proposing on PART 2, Davis-Bacon Act compliance.**

IF proposing on PART 2, Texas Statute requires compliance with Davis-Bacon Act, as amended (40 U.S.C. 3141-3148). When required by Federal program legislation, all prime construction contracts in excess of \$2,000 awarded by non-Federal entities must include a provision for compliance with the Davis-Bacon Act (40 U.S.C. 3141-3144, and 3146-3148) as supplemented by Department of Labor regulations (29 CFR Part S, "Labor Standards Provisions Applicable to Contracts Covering Federally Financed and Assisted Construction"). In accordance with the statute, contractors must be required to pay wages to laborers and mechanics at a rate not less than the prevailing wages specified in a wage determination made by the Secretary of Labor. In addition, contractors must be required to pay wages not less than once a week. The non-Federal entity must place a copy of the current prevailing wage determination issued by the Department of Labor in each solicitation. The decision to award a contract or subcontract must be conditioned upon the acceptance of the wage determination. The non-Federal entity must report all suspected or reported violations to the Federal awarding agency. The contracts must also include a provision for compliance with the Copeland "Anti-Kickback" Act {40 U.S.C. 314S), as supplemented by Department of Labor regulations (29 CFR Part 3, "Contractors and Subcontractors on Public Building or Public Work Financed in Whole or in Part by Loans or Grants from the United States"). The Act provides that each contractor or subrecipient must be prohibited from inducing, by any means, any person employed in the construction, completion, or repair of public work, to give up any part of the compensation to which he or she is otherwise entitled. The non-Federal entity must report all suspected or reported violations to the Federal awarding agency.

BY SUBMITTING A PROPOSAL FOR PART 2 OF THIS SOLICITATION, the Vendor agrees, AS REQUIRED BY LAW, to comply with the Davis Bacon Act, IF APPLICABLE and if proposing on PART 2 of this solicitation.

**7  
2** **Contract Work Hours and Safety Standards Act (40 U.S.C. 3701-3708)**

Where applicable, all contracts awarded by the non-Federal entity in excess of \$100,000 that involve the employment of mechanics or laborers must include a provision for compliance with 40 U.S.C. 3702 and 3704, as supplemented by Department of Labor regulations (29 CFR Part 5). Under 40 U.S.C. 3702 of the Act, each contractor must be required to compute the wages of every mechanic and laborer on the basis of a standard work week of 40 hours. Work in excess of the standard work week is permissible provided that the worker is compensated at a rate of not less than one and a half times the basic rate of pay for all hours worked in excess of 40 hours in the work week. The requirements of 40 U.S.C. 3704 are applicable to construction work and provide that no laborer or mechanic must be required to work in surroundings or under working conditions which are unsanitary, hazardous or dangerous. These requirements do not apply to the purchases of supplies or materials or articles ordinarily available on the open market, or contracts for transportation or transmission of intelligence.

By submitting a proposal to PART 2 of this solicitation and IF the customer is utilizing federal funds as described above, the Vendor agrees to comply with the Contract Work Hours and Safety Standards Act (40 U.S.C. 3701-3708).

**7  
3** **Indemnification**

The ESC Region 8 and TIPS is a Texas Political Subdivision and a local governmental entity; therefore, is prohibited from indemnifying third parties pursuant to the Texas Constitution (Article 3, Section 52) except as specifically provided by law or as ordered by a court of competent jurisdiction. A provision in a contract to indemnify or hold a party harmless is a promise to pay for any expenses the indemnified party incurs, if a specified event occurs, such as breaching the terms of the contract or negligently performing duties under the contract. Article III, Section 49 of the Texas Constitution states that "no debt shall be created by or on behalf of the State ... " The Attorney General has counseled that a contractually imposed obligation of indemnity creates a "debt" in the constitutional sense. Tex. Att'y Gen. Op. No. MW-475 (1982). Contract clauses which require the System or institutions to indemnify must be deleted or qualified with "to the extent permitted by the Constitution and Laws of the State of Texas." Liquidated damages, attorney's fees, waiver of vendor's liability, and waiver of statutes of limitations clauses should also be deleted or qualified with "to the extent permitted by the Constitution and laws of State of Texas."

Do you agree to these terms?

Yes, I Agree (Yes)

**7  
4** **Remedies**

The parties shall be entitled to exercise any right or remedy available to it either at law or in equity, subject to the choice of law, venue and service of process clauses limitations agreed herein. Nothing in this agreement shall commit the TIPS to an arbitration resolution of any disagreement under any circumstances. Any Claim arising out of or related to the Contract, except for those specifically waived under the terms of the Contract, may, after denial of the Board of Directors, be subject to mediation at the request of either party. Any issues not resolved hereunder MAY be referred to non-binding mediation to be conducted by a mutually agreed upon mediator as a prerequisite to the filing of any lawsuit over such issue(s). The parties shall share the mediator's fee and any associated filing fee equally. Mediation shall be held in Camp or Titus County, Texas. Agreements reached in mediation shall be reduced to writing, and will be subject to the approval by the District's Board of Directors, signed by the Parties if approved by the Board of Directors, and, if signed, shall thereafter be enforceable as provided by the laws of the State of Texas.

Do you agree to these terms?

**7  
5** **Remedies Explanation of No Answer**

**7  
6** **Choice of Law**

The agreement between the Vendor and TIPS/ESC Region 8 and any addenda or other additions resulting from this procurement process, however described, shall be governed by, construed and enforced in accordance with the laws of the State of Texas, regardless of any conflict of laws principles.  
THIS DOES NOT APPLY to a vendor's agreement entered into with a TIPS Member, as the Member may be located outside Texas.

Do you agree to these terms?

**7  
7** **Venue, Jurisdiction and Service of Process**

Any proceeding, involving Region 8 ESC or TIPS, arising out of or relating to this procurement process or any contract issued by TIPS resulting from or any contemplated transaction shall be brought in a court of competent jurisdiction in Camp County, Texas and each of the parties irrevocably submits to the exclusive jurisdiction of said court in any such proceeding, waives any objection it may now or hereafter have to venue or to convenience of forum, agrees that all claims in respect of the Proceeding shall be heard and determined only in any such court, and agrees not to bring any proceeding arising out of or relating to this procurement process or any contract resulting from or any contemplated transaction in any other court. The parties agree that either or both of them may file a copy of this paragraph with any court as written evidence of the knowing, voluntary and freely bargained for agreement between the parties irrevocably to waive any objections to venue or to convenience of forum. Process in any Proceeding referred to in the first sentence of this Section may be served on any party anywhere in the world. Any dispute resolution process other than litigation shall have venue in Camp County or Titus County Texas.

Do you agree to these terms?

**7  
8** **Alternative Dispute Resolution Explanation of No Answer**

**7  
9** **Infringement(s)**

The successful vendor will be expected to indemnify and hold harmless the TIPS and its employees, officers, agents, representatives, contractors, assignees and designees from any and all third party claims and judgments involving infringement of patent, copyright, trade secrets, trade or service marks, and any other intellectual or intangible property rights attributed to or claims based on the Vendor's proposal or Vendor's performance of contracts awarded and approved.

Do you agree to these terms?

**8  
0** **Infringement(s) Explanation of No Answer**

**8  
1** **Acts or Omissions**

The successful vendor will be expected to indemnify and hold harmless the TIPS, its officers, employees, agents, representatives, contractors, assignees and designees from and against any and all liability, actions, claims, demands or suits, and all related costs, attorney's fees and expenses arising out of, or resulting from any acts or omissions of the vendor or its agents, employees, subcontractors, or suppliers in the execution or performance of any agreements ultimately made by TIPS and the vendor.

Do you agree to these terms?

**8** Acts or Omissions Explanation of No Answer

**2**

No response

**8** Contract Governance

**3**

Any contract made or entered into by the TIPS is subject to and is to be governed by Section 271.151 et seq, Tex Loc Gov't Code. Otherwise, TIPS does not waive its governmental immunities from suit or liability except to the extent expressly waived by other applicable laws in clear and unambiguous language.

Yes, I Agree (Yes)

**8** Payment Terms and Funding Out Clause

**4**

Payment Terms:

TIPS or TIPS members shall not be liable for interest or late payment fees on past due balances at a rate higher than permitted by the laws or regulations of the jurisdiction of the TIPS Member.

Funding Out Clause:

Vendor agrees to abide by the laws and regulations, including Texas Local Government Code § 271.903, or any statutory or regulatory limitations of the jurisdiction of any TIPS Member which governs contracts entered into by the Vendor and TIPS or a TIPS Member that requires all contracts approved by TIPS or a TIPS Member are subject to the budgeting and appropriation of currently available funds by the entity or its governing body.

See statute(s) for specifics or consult your legal counsel.

Not a negotiable term. Failure to agree will render your proposal non-responsive and it will not be considered.

Do you agree to these terms?

Yes, I Agree (Yes)

**8**  
**5** **Insurance and Fingerprint Requirements Information**

Insurance

If applicable and your staff will be on TIPS member premises for delivery, training or installation etc. and/or with an automobile, you must carry automobile insurance as required by law. You may be asked to provide proof of insurance.

Fingerprint

It is possible that a vendor may be subject to Chapter 22 of the Texas Education Code. The Texas Education Code, Chapter 22, Section 22.0834 & 22.08341. Statutory language may be found at: <http://www.statutes.legis.state.tx.us/>

If the vendor has staff that meet both of these criterion:

- (1) will have continuing duties related to the contracted services; and
- (2) has or will have direct contact with students

Then you have "covered" employees for purposes of completing the attached form.

TIPS recommends all vendors consult their legal counsel for guidance in compliance with this law. If you have questions on how to comply, see below. If you have questions on compliance with this code section, contact the Texas Department of Public Safety Non-Criminal Justice Unit, Access and Dissemination Bureau, FAST-FACT at [NCJU@txdps.state.tx.us](mailto:NCJU@txdps.state.tx.us) and you should send an email identifying you as a contractor to a Texas Independent School District or ESC Region 8 and TIPS. Texas DPS phone number is (512) 424-2474.

See form in the next attribute to complete entitled:  
Texas Education Code Chapter 22 Contractor Certification for Contractor Employees

**Texas Education Code Chapter 22 Contractor Certification for Contractor Employees**

Introduction: Texas Education Code Chapter 22 requires entities that contract with school districts to provide services to obtain criminal history record information regarding covered employees. Contractors must certify to the district that they have complied. Covered employees with disqualifying criminal histories are prohibited from serving at a school district.

Definitions: Covered employees: Employees of a contractor or subcontractor who have or will have continuing duties related to the service to be performed at the District and have or will have direct contact with students. The District will be the final arbiter of what constitutes direct contact with students. Disqualifying criminal history: Any conviction or other criminal history information designated by the District, or one of the following offenses, if at the time of the offense, the victim was under 18 or enrolled in a public school:

(a) a felony offense under Title 5, Texas Penal Code; (b) an offense for which a defendant is required to register as a sex offender under Chapter 62, Texas Code of Criminal Procedure; or (c) an equivalent offense under federal law or the laws of another state.

I certify that:

**NONE (Section A)** of the employees of Contractor and any subcontractors are covered employees, as defined above. If this box is checked, I further certify that Contractor has taken precautions or imposed conditions to ensure that the employees of Contractor and any subcontractor will not become covered employees. Contractor will maintain these precautions or conditions throughout the time the contracted services are provided.

**OR**

**SOME (Section B)** or all of the employees of Contractor and any subcontractor are covered employees. If this box is checked, I further certify that:

(1) Contractor has obtained all required criminal history record information regarding its covered employees. None of the covered employees has a disqualifying criminal history.

(2) If Contractor receives information that a covered employee subsequently has a reported criminal history, Contractor will immediately remove the covered employee from contract duties and notify the District in writing within 3 business days.

(3) Upon request, Contractor will provide the District with the name and any other requested information of covered employees so that the District may obtain criminal history record information on the covered employees.

(4) If the District objects to the assignment of a covered employee on the basis of the covered employee's criminal history record information, Contractor agrees to discontinue using that covered employee to provide services at the District.

Noncompliance or misrepresentation regarding this certification may be grounds for contract termination.

None

**8** **Texas Business and Commerce Code § 272 Requirements as of 9-1-2017**

**7** SB 807 prohibits construction contracts to have provisions requiring the contract to be subject to the laws of another state, to be required to litigate the contract in another state, or to require arbitration in another state. A contract with such provisions is voidable. Under this new statute, a "construction contract" includes contracts, subcontracts, or agreements with (among others) architects, engineers, contractors, construction managers, equipment lessors, or materials suppliers. "Construction contracts" are for the design, construction, alteration, renovation, remodeling, or repair of any building or improvement to real property, or for furnishing materials or equipment for the project. The term also includes moving, demolition, or excavation. BY RESPONDING TO THIS SOLICITATION, AND WHEN APPLICABLE, THE PROPOSER AGREES TO COMPLY WITH THE TEXAS BUSINESS AND COMMERCE CODE § 272 WHEN EXECUTING CONTRACTS WITH TIPS MEMBERS THAT ARE TEXAS GOVERNMENT ENTITIES.

**8** **Texas Government Code 2270 & 2270 Verification Form**

**8** Texas Government Code 2270 & 2271 Verification Form  
If (a) Vendor is not a sole proprietorship; (b) Vendor has ten (10) or more full-time employees; and (c) this Agreement has a value of \$100,000 or more, the following certification shall apply; otherwise, this certification is not required. Pursuant to Chapter 2271 of the Texas Government Code, the Vendor hereby certifies and verifies that neither the Vendor, nor any affiliate, subsidiary, or parent company of the Vendor, if any (the "Vendor Companies"), boycotts Israel, and the Vendor agrees that the Vendor and Vendor Companies will not boycott Israel during the term of this Agreement. For purposes of this Agreement, the term "boycott" shall mean and include refusing to deal with, terminating business activities with, or otherwise taking any action that is intended to penalize, inflict economic harm on, or limit commercial relations with Israel, or with a person or entity doing business in Israel or in an Israeli-controlled territory, but does not include an action made for ordinary business purposes.  
Our entity further certifies that it is is not listed on and we do not do business with companies prohibited by Texas Government Code 2270 or that are on the Texas Comptroller of Public Accounts list of Designated Foreign Terrorists Organizations per Texas Gov't Code 2270.0153 found at <https://comptroller.texas.gov/purchasing/docs/foreign-terrorist.pdf>  
I swear and affirm that the above is true and correct.  
 YES

**8** **Logos and other company marks**

**9** Please upload your company logo to be added to your individual profile page on the TIPS website. If any particular specifications are required for use of your company logo, please upload that information under the "Logo and Other Company Marks" section under the "Response Attachment" tab. Preferred Logo Format: 300 x 225 px - .png, .eps, .jpeg preferred

Potential uses of company logo:

- \* Your Vendor Profile Page of TIPS website
- \* Potentially on TIPS website scroll bar for Top Performing Vendors
- \* TIPS Quarterly eNewsletter sent to TIPS Members
- \* Co-branding Flyers and or email blasts to our TIPS Members (Permission and approval will be obtained before publishing)

<b>9 0</b>	<b>Solicitation Deviation/Compliance</b> Does the vendor agree with the General Conditions Standard Terms and Conditions or Item Specifications listed in this proposal invitation? <input type="text" value="Yes"/>
----------------	--

<b>9 1</b>	<b>Solicitation Exceptions/Deviations Explanation</b> If the bidder intends to deviate from the General Conditions Standard Terms and Conditions or Item Specifications listed in this proposal invitation, all such deviations must be listed on this attribute, with complete and detailed conditions and information included or attached. TIPS will consider any deviations in its proposal award decisions, and TIPS reserves the right to accept or reject any bid based upon any deviations indicated below or in any attachments or inclusions. In the absence of any deviation entry on this attribute, the proposer assures TIPS of their full compliance with the Standard Terms and Conditions, Item Specifications, and all other information contained in this Solicitation. <input type="text" value="No response"/>
----------------	---

<b>9 2</b>	<b>Agreement Deviation/Compliance</b> Does the vendor agree with the language in the Vendor Agreement? <input type="text" value="Yes"/>
----------------	---

<b>9 3</b>	<b>Agreement Exceptions/Deviations Explanation</b> If the proposing Vendor desires to deviate from the Vendor Agreement language, all such deviations must be listed on this attribute, with complete and detailed conditions and information included. TIPS will consider any deviations in its proposal award decisions, and TIPS reserves the right to accept or reject any proposal based upon any deviations indicated below. In the absence of any deviation entry on this attribute, the proposer assures TIPS of their full compliance with the Vendor Agreement. <input type="text" value="No response"/>
----------------	--

<b>9 4</b>	<b>Long Term Cost Evaluation Criterion on PART 1 EVALUATION ONLY</b> READ CAREFULLY and see in the RFP document under "Proposal Scoring and Evaluation". Points will be assigned to this criterion based on your answer to this Attribute. Points are awarded if you agree not increase your catalog prices (as defined herein) more than X% annually over the previous year for the life of the contract, unless an exigent circumstance exists in the marketplace and the excess price increase which exceeds X% annually is supported by documentation provided by you and your suppliers and shared with TIPS, if requested. If you agree NOT to increase prices more than 5%, except when justified by supporting documentation, you are awarded 10 points; if 6% to 14%, except when justified by supporting documentation, you receive 1 to 9 points incrementally. Price increases 14% or greater, except when justified by supporting documentation, receive 0 points. <input type="text" value="price increases will be &lt; 5% annually per question"/>
----------------	---



**9  
5** **Felony Conviction Notice**

Texas Education Code, Section 44.034, Notification of Criminal History, Subsection (a), states “a person or business entity that enters into a contract with a school district must give advance notice to the district if the person or an owner or operator of the business entity has been convicted of a felony. The notice must include a general description of the conduct resulting in the conviction of a felony.” Subsection (b) states “a school district may terminate a contract with a person or business entity if the district determines that the person or business entity failed to give notice as required by Subsection (a) or misrepresented the conduct resulting in the conviction. The district must compensate the person or business entity for services performed before the termination of the contract.” (c) This section does not apply to a publicly held corporation. The person completing this proposal certifies that they are authorized to provide the answer to this question.

Select A., B. or C.

A. My firm is a publicly held corporation; therefore, this reporting requirement is not applicable.

OR B. My firm is not owned nor operated by anyone who has been convicted of a felony, OR

C. My firm is owned or operated by the following individual(s) who has/have been convicted of a felony. (if you answer C below, you are required to provide information in the next attribute.

B. Firm not owned nor operated by felon; per above

**9  
6** **If you answered C. My Firm is owned or operated by a felon to the previous question, you are REQUIRED TO ANSWER THE FOLLOWING QUESTIONS.**

If you answered C. My Firm is owned or operated by a felon to the previous question, you must provide the following information.

1. Name of Felon(s)
2. The named person's role in the firm, and
3. Details of Conviction(s).

No response

**9  
7** **Required Confidentiality Claim Form**

Required Confidentiality Claim Form

This completed form is required by TIPS. By submitting a response to this solicitation you agree to download from the “Attachments” section, complete according to the instructions on the form, then upload the completed form, with any confidential attachments, if applicable, to the “Response Attachments” section titled “Confidentiality Form” in order to provide to TIPS the completed form titled, “CONFIDENTIALITY CLAIM FORM”. **THIS REQUIRED PROCESS IS THE ONLY WAY TO DEEM PROPOSAL DOCUMENTATION CONFIDENTIAL ANY OTHER CONFIDENTIAL DESIGNATION WILL BE DISREGARDED UNLESS THE DOCUMENT IS IDENTIFIED BY AND ATTACHED TO THE REQUIRED FORM.** By completing this process, you provide us with the information we require to comply with the open record laws of the State of Texas as they may apply to your proposal submission. If you do not provide the form with your proposal, an award will not be made if your proposal is qualified for an award, until TIPS has an accurate, completed form from you.

Read the form carefully before completing and if you have any questions, email bids@tips-usa.com.

**9  
8** **Choice of Law clauses for TIPS Members**

If the vendor is awarded a contract with TIPS under this solicitation, the vendor agrees to make any Choice of Law clauses in any contract or agreement entered into between the awarded vendor and with a TIPS member entity to read as follows: "Choice of law shall be the laws of the state where the customer resides" or words to that effect.

Agreed

99

**Venue of dispute resolution with a TIPS Member**

In the event of litigation or use of any dispute resolution model when resolving disputes with a TIPS member entity as a result of a transaction between the vendor and TIPS or the TIPS member entity, the Venue for any litigation or other agreed upon model shall be in the state and county where the customer resides unless otherwise agreed by the parties at the time the dispute resolution model is decided by the parties.

100

**Indemnity Limitation with TIPS Members**

Texas and other states restrict by law or state Constitution the ability of a governmental entity to indemnify others. TIPS requires that any contract entered into between a vendor and TIPS or a TIPS Member as a result of an award under this Solicitation limit the requirement that the Customer indemnify the Vendor by either eliminating any such indemnity requirement clauses in any agreements, contracts or other binding documents **OR** by prefacing all indemnity clauses required of TIPS or the TIPS Member entity with the following: "To the extent permitted by the laws or the Constitution of the state where the customer resides, ".

**Agreement is a required condition to award of a contract resulting from this Solicitation.**

101

**Arbitration Clauses**

Except for certain circumstances, TIPS forbids a mandatory arbitration clause in any contract or agreement entered into between the awarded vendor with TIPS or a TIPS member entity. Does the vendor agree to exclude any arbitration requirement in any contracts or agreement entered into between TIPS or a TIPS member entity through an awarded contract with TIPS?

**Agreement is a required condition to award of a contract resulting from this Solicitation.**

102

**Upload of Current W-9 Required**

Please note that you are required by TIPS to upload a current W-9 Internal Revenue Service (IRS) Tax Form for your entity. This form will be utilized by TIPS to properly identify your entity.



CERTIFICATION BY CORPORATE OFFERER

**COMPLETE ONLY IF OFFERER IS A CORPORATION,**  
**THE FOLLOWING CERTIFICATE SHOULD BE EXECUTED AND INCLUDED AS PART OF**  
**PROPOSAL FORM/PROPOSAL FORM.**

OFFERER: Neutex Advanced Energy Group  
(Name of Corporation)

MARK E. SAM certify that I am the Secretary of the Corporation  
I, (Name of Corporate Secretary)  
COO/CFO

named as OFFERER herein above; that  
Andrea Duhon

(Name of person who completed proposal document)

who signed the foregoing proposal on behalf of the corporation offerer is the authorized person that is  
acting as  
Factory Direct Sales Coordinator

(Title/Position of person signing proposal/offer document within the corporation)

of the said Corporation; that said proposal/offer was duly signed for and in behalf of said corporation by  
authority of its governing body, and is within the scope of its corporate powers.



CORPORATE SEAL if available

ME SAM, COO/CFO  
SIGNATURE

7/15/2021  
DATE

**Required Confidential Information Status Form**

Neutex Advanced Energy Group

Name of company

Andrea Duhon Factory Direct Sales Coordinator

Printed Name and Title of authorized company officer declaring below the confidential status of material

15700 Vickery Dr

Houston

TX 77032

281-253-4509

Address

City

State

ZIP

Phone

**ALL VENDORS MUST COMPLETE THE ABOVE SECTION**

CONFIDENTIAL INFORMATION SUBMITTED IN RESPONSE TO COMPETITIVE PROCUREMENT REQUESTS OF EDUCATION SERVICE CENTER REGION 8 AND TIPS (ESC8) IS GOVERNED BY TEXAS GOVERNMENT CODE, CHAPTER 552

If you consider any portion of your proposal to be confidential information and not subject to public disclosure pursuant to Chapter 552 Texas Gov't Code or other law(s), you **must attach a copy of all claimed confidential materials within your proposal and put this COMPLETED form as a cover sheet to said materials then scan, name "CONFIDENTIAL" and upload with your proposal submission.** (You must include all the confidential information in the submitted proposal. The copy uploaded is to indicate which material in your proposal, if any, you deem confidential in the event the receives a Public Information Request.) ESC8 and TIPS will follow procedures of controlling statute(s) regarding any claim of confidentiality and shall not be liable for any release of information required by law. Upon your claim and your defense to the Office of Texas Attorney General is required to make the final determination whether the information submitted by you and held by ESC8 and TIPS is confidential and exempt from public disclosure.

**ALL VENDORS MUST COMPLETE ONE OF THE TWO OPTIONS BELOW.**

**OPTION 1:**

**I DO CLAIM** parts of my proposal to be confidential and **DO NOT** desire to expressly waive a claim of confidentiality of all information contained within our response to the solicitation. The attached contains material from our proposal that I classify and deem confidential under Texas Gov't Code Sec. 552 or other law(s) and I invoke my statutory rights to confidential treatment of the enclosed materials.

**IF CLAIMING PARTS OF YOUR PROPOSAL CONFIDENTIAL, YOU MUST ATTACH THE SHEETS TO THIS FORM AND LIST THE NUMBER OT TOTAL PAGES THAT ARE CONFIDENTIAL.**

**ATTACHED** ARE COPIES OF \_\_\_\_\_ PAGES OF CLAIMED CONFIDENTIAL MATERIAL FROM OUR PROPOSAL THAT WE DEEM TO BE NOT PUBLIC INFORMATION AND WILL DEFEND THAT CLAIM TO THE TEXAS ATTORNEY GENERAL IF REQUESTED WHEN A PUBLIC INFORMATION REQUEST IS MADE FOR OUR PROPOSAL.

Signature \_\_\_\_\_ Date 7/15/21

**OR**

**OPTION 2:**

**I DO NOT CLAIM** any of my proposal to be confidential, complete the section below.

**Express Waiver:** I desire to expressly waive any claim of confidentiality as to any and all information contained within our response to the competitive procurement process (e.g. RFP, CSP, Bid, RFQ, etc.) by completing the following and submitting this sheet with our response to Education Service Center Region 8 and TIPS.

Signature Andrea Duhon Date 7/15/21



## FEATURES

- DLC Standard with isolated external power supply
- PF>0.95, Power Efficiency: >0.87
- LGP 4mm thick, imported from Taiwan
- 5 years warranty
- High efficiency: 85lm/w
- 4014SMD LED, LM80
- CRI: Ra>80
- Dimmable option is available
- Energy Saving & Super bright, saving 75% energy compared with traditional panel lights

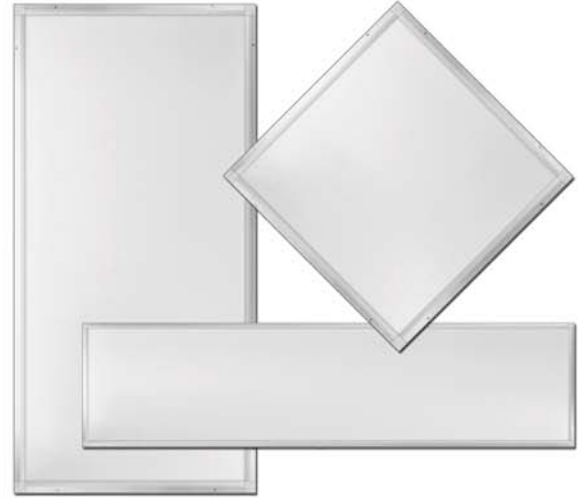

## DIMENSIONS

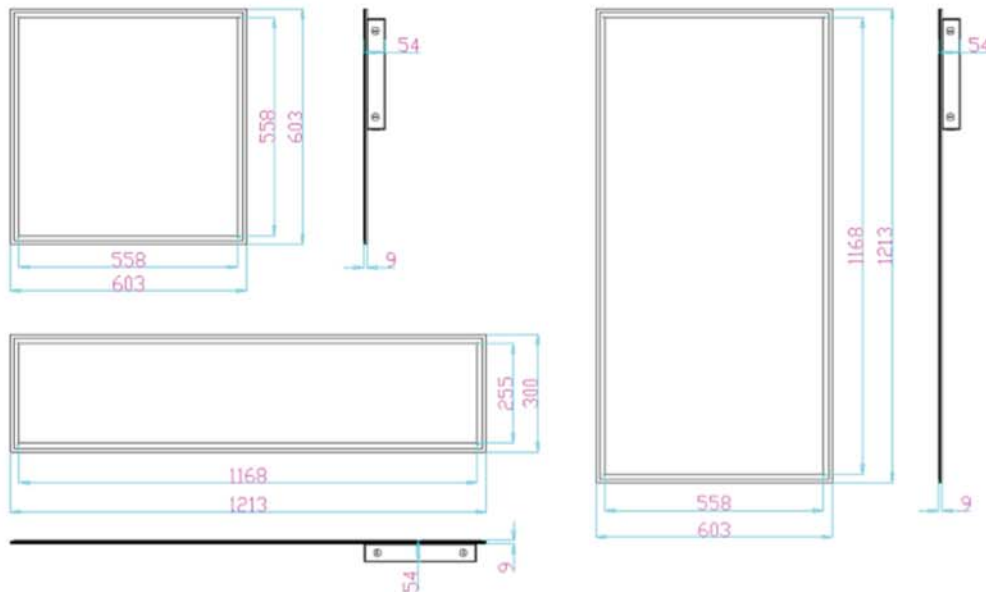

## CORRELATED COLOR TEMPERATURE CHART





## TECHNICAL SPECIFICATIONS

- Power Supply: With External Constant Current Power Supply
- Input Voltage: AC100V~277V
- Frequency Range: 50Hz~60Hz
- Total Harmonic Distortion: ≤ 15 %
- Power Factor: >0.95
- Power Efficiency: >87 %
- LED Type: SMD 4014
- Color Temperature: WW(3000K), NW(4000K), CW(5000K)
- Color Rendering Index: Ra>82
- Beam Angle: 120°
- Dimmable Function: Dimmable optional
- Material: AL+PMMA+PS
- Working Temperature: -20° ~ +45°
- Storage Temperature: -25° ~ +65°
- IP Grade: IP20
- Working Life-span: 5,0000H

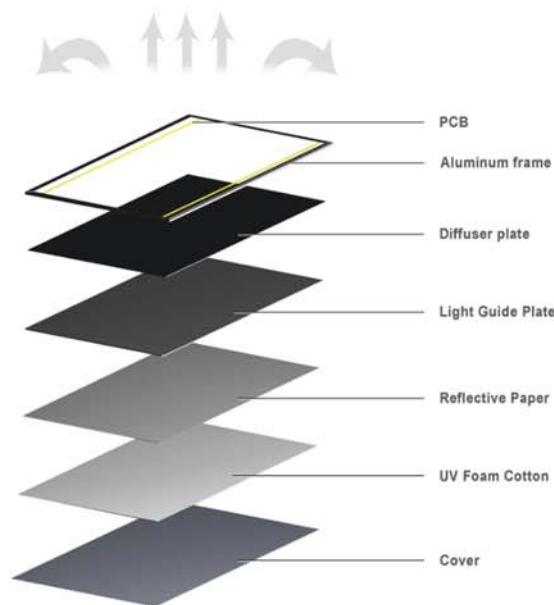

## PARAMETERS

### 1.0-10V Dimmable Version

Item	Power	Input Voltage	Lumens (lm)	SMD4014 LED Qty	Size(mm)	Efficiency	Output Voltage	Current (mA)	CCT
FP36BDB2TN	36W	AC100-277V	3060±5%	192	603*603*9	85lm/w (up to 110lm/w)	36VDC	900mA	W(Warm White) 3045K±175K
FP45BDB2TN	45W	AC100-277V	3825±5%	192	603*603*9		36VDC	1100mA	N(Natural White) 3985K±275K
FP36BDA4TN	36W	AC100-277V	3060±5%	192	1213*301*9		36VDC	900mA	C(Cool White) 5028K±283K
FP45BDA4TN	45W	AC100-277V	3825±5%	192	1213*301*9		36VDC	1100mA	
FP60BDB4TN	60W	AC100-277V	5100±5%	384	1213*603*9		36VDC	1500mA	
FP72BDB4TN	72W	AC100-277V	6100±5%	384	1213*603*9		36VDC	1800mA	

### CORRELATED COLOR TEMPERATURE CHART





## LUMINOUS INTENSITY DISTRIBUTION

LUMINOUS INTENSITY DISTRIBUTION DIAGRAM

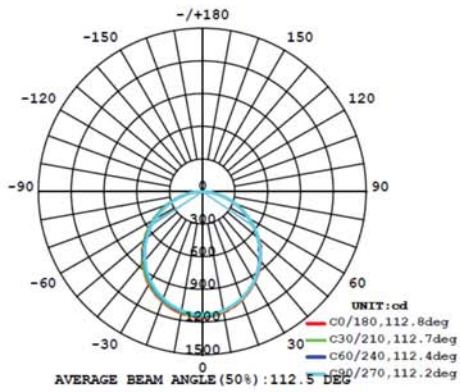

**FP36BDB2TN**

Flux out: 2345 lm

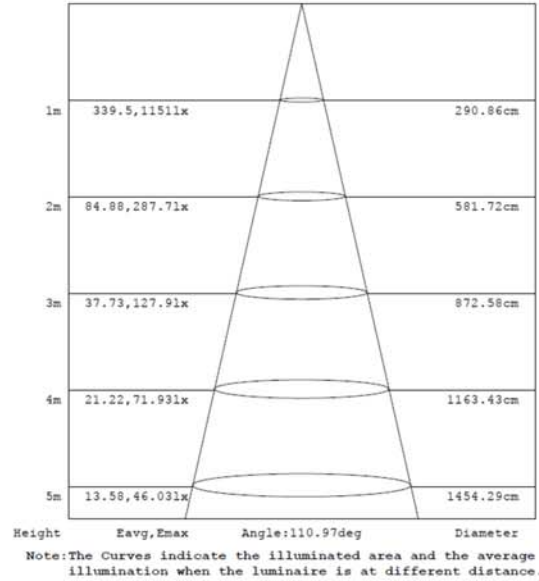

**FP36BDB2TN**

LUMINOUS INTENSITY DISTRIBUTION DIAGRAM

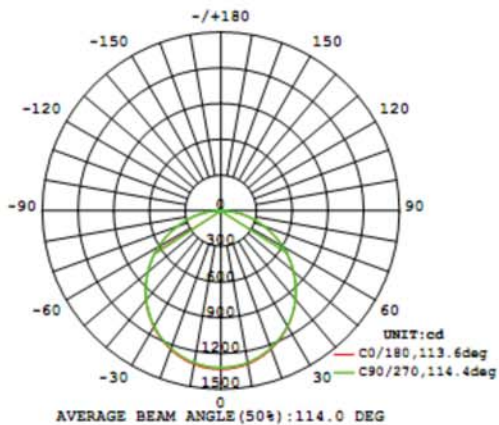

**FP45BDB2TN**

Flux out: 2020 lm

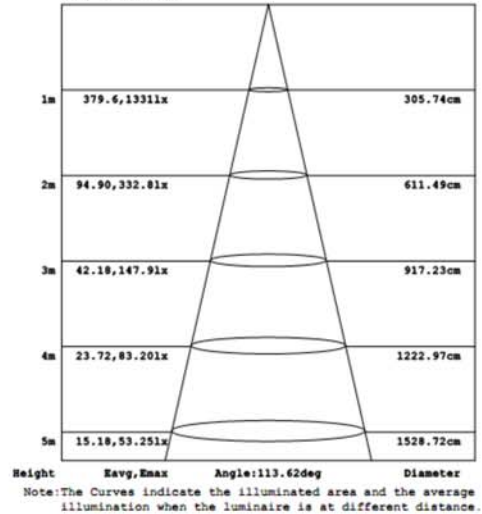

**FP45BDB2TN**

### CORRELATED COLOR TEMPERATURE CHART







**DESIGNLIGHTS**  
CONSORTIUM

## DLC 2x2 FLAT PANEL SERIES

FP36BDB2TN  
FP45BDB2TN



### APPLICATIONS

- Hospitals & Hotels
- Factory & Office
- Airport & Metro
- Conference & Meeting Rooms
- K-12, Higher Education
- Stockroom
- Garage & Warehouse
- Commercial Purposes

### WARNING

- Use product within the specified range of voltage
- Follow correct installation steps to install product; do not touch when fixture is lit
- Turn off power when installing and removing products to avoid risk of electrical shock
- Please install the panel in the correct sized fixture
- Do not look directly at LED light source for any extended period of time

### CORRELATED COLOR TEMPERATURE CHART

3000K 4000K 5000K 6000K

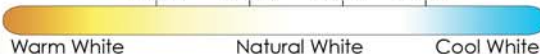



## A. EMBEDDED INSTALLATION

1. Move away ceiling plaster slab
2. Connect the wire
3. Place panel light to suitable place
4. Put panel light steadily

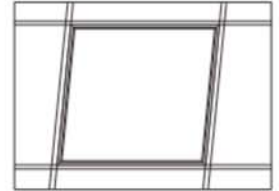
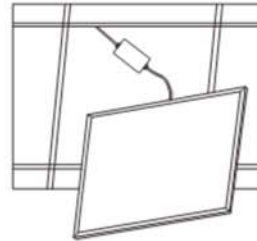
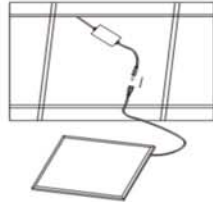
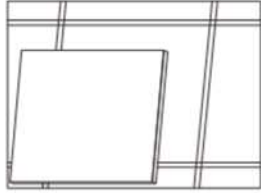

## B. HANGING ON CEILING

1. Fix the hook and screws on ceiling
2. Connect the steel wire rope to the panel light
3. Hang the retaining rings on the hook
4. Connect the power supply

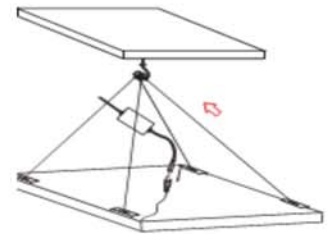
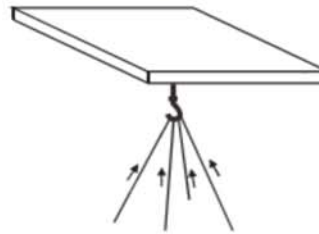
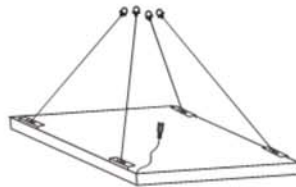
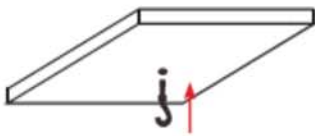

## C. HANGING ON WALL

1. Fix screws into the hole site
2. Hang the panel into the screws and connect the power supply

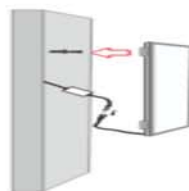
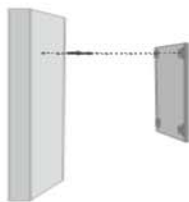

### CORRELATED COLOR TEMPERATURE CHART

3000K 4000K 5000K 6000K



Warm White

Natural White

Cool White



## SYSTEM CONNECTION DIAGRAM

A. Wiring of the panel light with non-dimmable driver

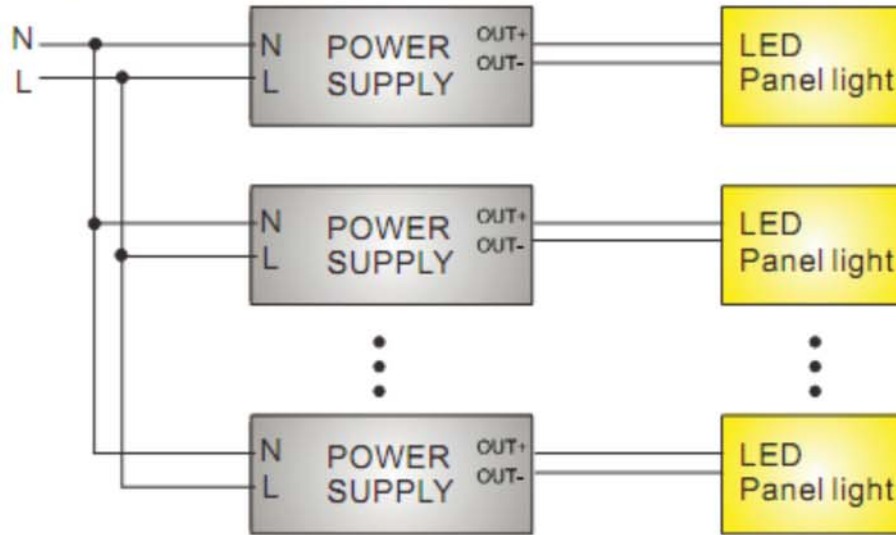

B. Wiring of the panel light with 0-10V dimmable driver

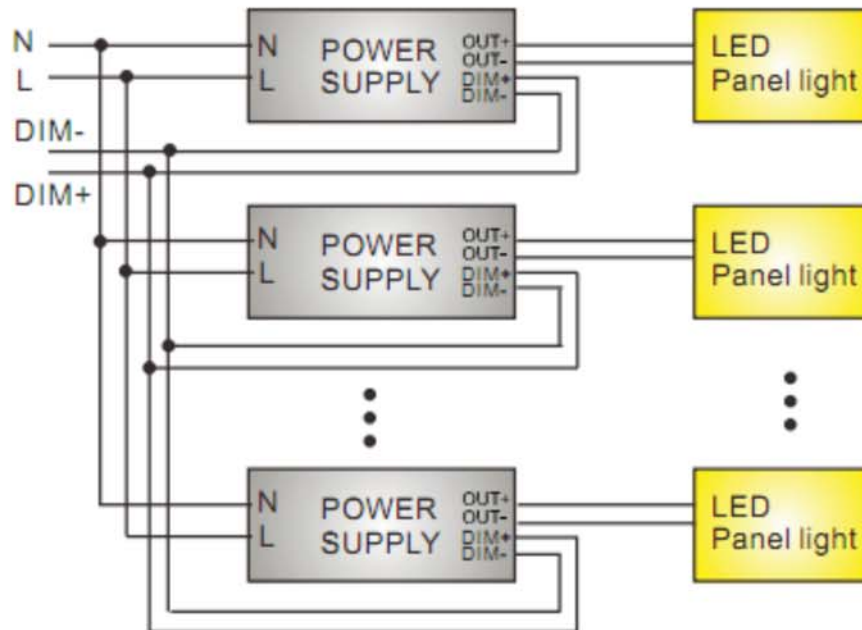

### CORRELATED COLOR TEMPERATURE CHART





## FEATURES

- DLC Standard with isolated external power supply
- PF>0.95, Power Efficiency: >0.87
- LGP 4mm thick, imported from Taiwan
- 5 years warranty
- High efficiency: 85lm/w
- 4014SMD LED, LM80
- CRI: Ra>80
- Dimmable option is available
- Energy Saving & Super bright, saving 75% energy compared with traditional panel lights

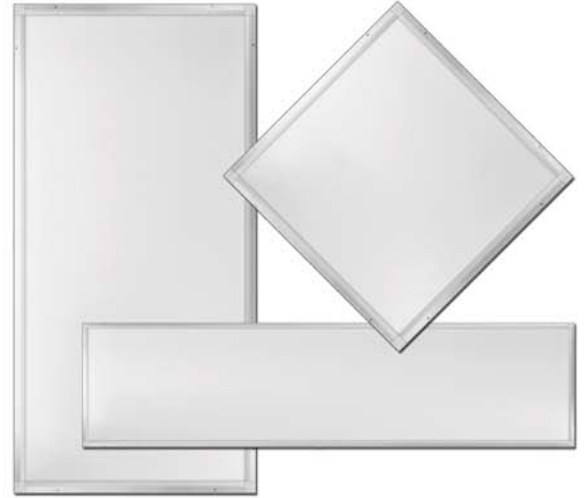

## DIMENSIONS

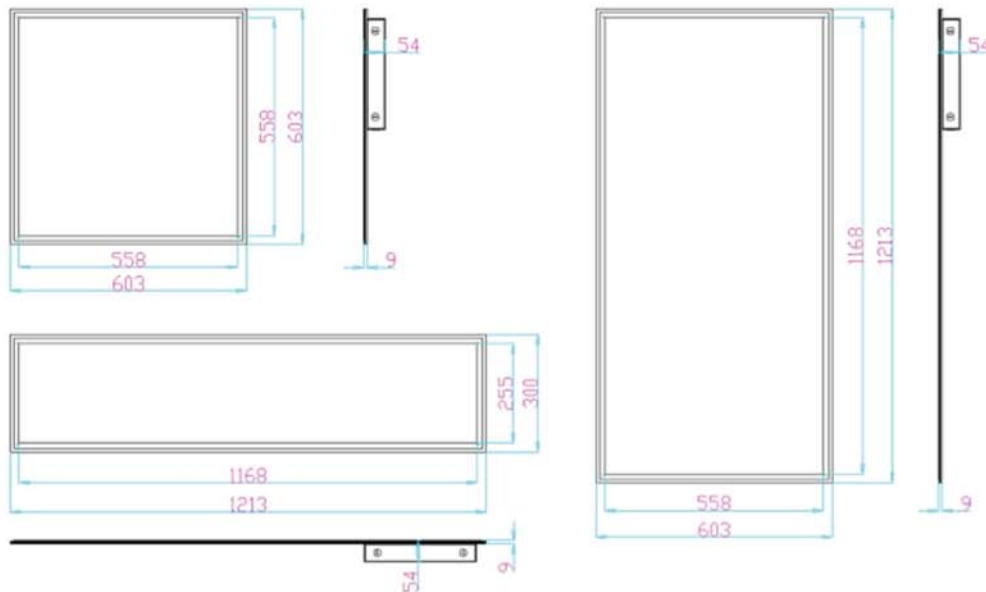

### CORRELATED COLOR TEMPERATURE CHART





## TECHNICAL SPECIFICATIONS

- Power Supply: With External Constant Current Power Supply
- Input Voltage: AC100V~277V
- Frequency Range: 50Hz~60Hz
- Total Harmonic Distortion: ≤ 15 %
- Power Factor: >0.95
- Power Efficiency: >87 %
- LED Type: SMD 4014
- Color Temperature: WW(3000K), NW(4000K), CW(5000K)
- Color Rendering Index: Ra>82
- Beam Angle: 120°
- Dimmable Function: Dimmable optional
- Material: AL+PMMA+PS
- Working Temperature: -20° ~ +45°
- Storage Temperature: -25° ~ +65°
- IP Grade: IP20
- Working Life-span: 5,0000H

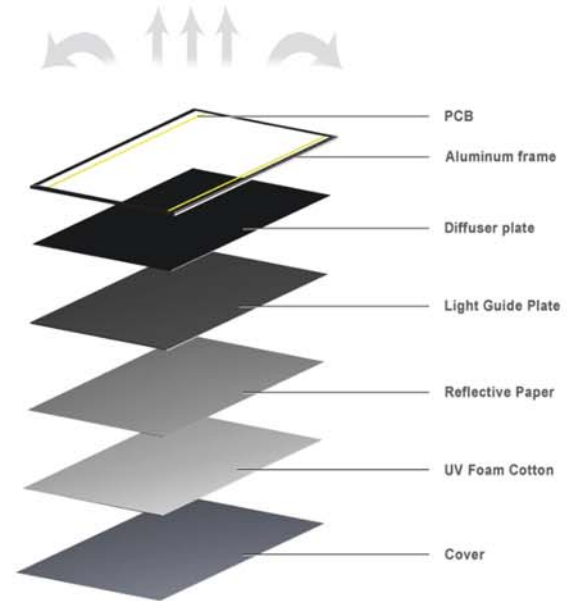

## PARAMETERS

### 1.0-10V Dimmable Version

Item	Power	Input Voltage	Lumens (lm)	SMD4014 LED Qty	Size(mm)	Efficiency	Output Voltage	Current (mA)	CCT
FP36BDB2TN	36W	AC100-277V	3060±5%	192	603*603*9	85lm/w (up to 110lm/w)	36VDC	900mA	W(Warm White) 3045K±175K
FP45BDB2TN	45W	AC100-277V	3825±5%	192	603*603*9		36VDC	1100mA	N(Natural White) 3985K±275K
FP36BDA4TN	36W	AC100-277V	3060±5%	192	1213*301*9		36VDC	900mA	C(Cool White) 5028K±283K
FP45BDA4TN	45W	AC100-277V	3825±5%	192	1213*301*9		36VDC	1100mA	
FP60BDB4TN	60W	AC100-277V	5100±5%	384	1213*603*9		36VDC	1500mA	
FP72BDB4TN	72W	AC100-277V	6100±5%	384	1213*603*9		36VDC	1800mA	

### CORRELATED COLOR TEMPERATURE CHART





**LUMINOUS INTENSITY DISTRIBUTION**

**LUMINOUS INTENSITY DISTRIBUTION DIAGRAM**

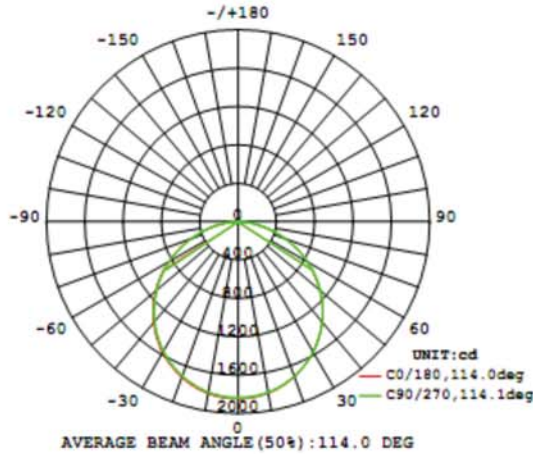

**FP60BDB4TN**

Flux out:3945 lm

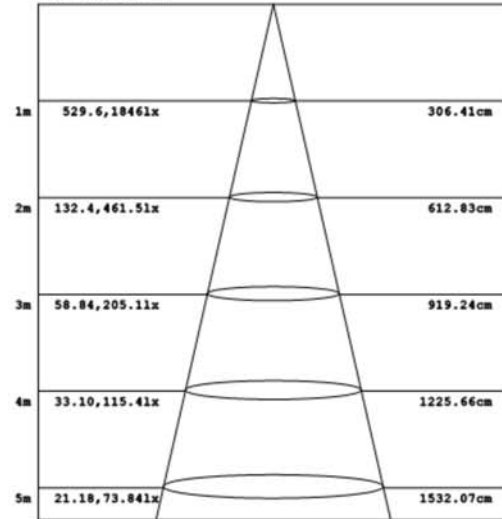

Note: The Curves indicate the illuminated area and the average illumination when the luminaire is at different distance.

**FP60BDB4TN**

**LUMINOUS INTENSITY DISTRIBUTION DIAGRAM**

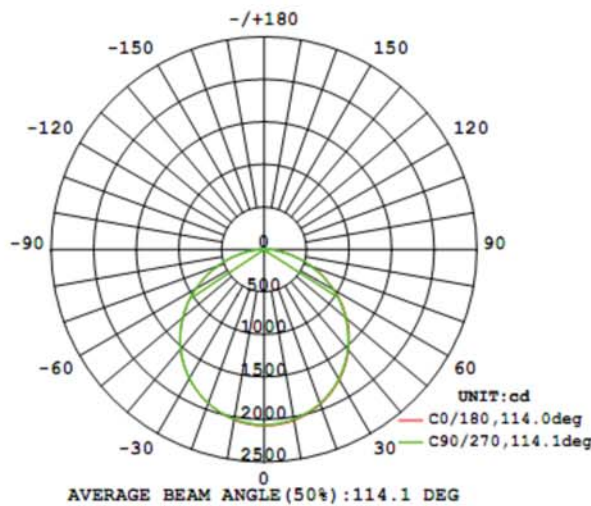

**FP72BDB4TN**

Flux out:4427 lm

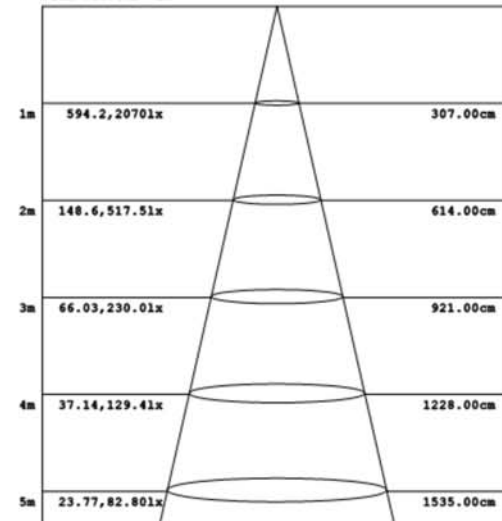

Note: The Curves indicate the illuminated area and the average illumination when the luminaire is at different distance.

**FP72BDB4TN**

**CORRELATED COLOR TEMPERATURE CHART**

3000K 4000K 5000K 6000K

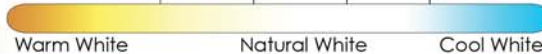



**DESIGNLIGHTS**  
CONSORTIUM

## DLC 2x4 FLAT PANEL SERIES

FP60BDB4TN  
FP72BDB4TN



### APPLICATIONS

- Hospitals & Hotels
- Factory & Office
- Airport & Metro
- Conference & Meeting Rooms
- K-12, Higher Education
- Stockroom
- Garage & Warehouse
- Commercial Purposes

### WARNING

- Use product within the specified range of voltage
- Follow correct installation steps to install product; do not touch when fixture is lit
- Turn off power when installing and removing products to avoid risk of electrical shock
- Please install the panel in the correct sized fixture
- Do not look directly at LED light source for any extended period of time

### CORRELATED COLOR TEMPERATURE CHART

3000K 4000K 5000K 6000K

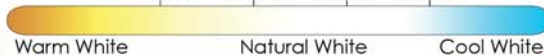

Warm White

Natural White

Cool White



## A. EMBEDDED INSTALLATION

1. Move away ceiling plaster slab
2. Connect the wire
3. Place panel light to suitable place
4. Put panel light steadily

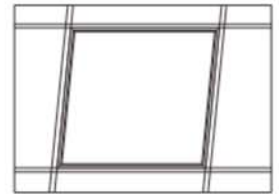
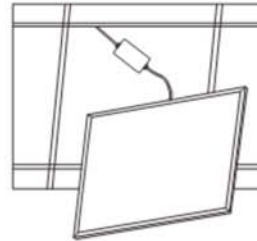
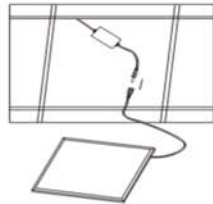
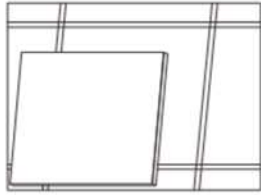

## B. HANGING ON CEILING

1. Fix the hook and screws on ceiling
2. Connect the steel wire rope to the panel light
3. Hang the retaining rings on the hook
4. Connect the power supply

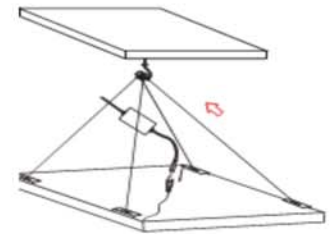
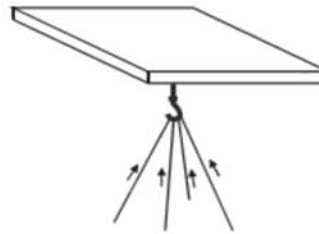
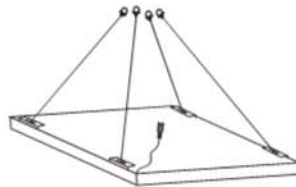
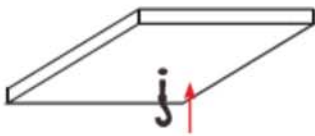

## C. HANGING ON WALL

1. Fix screws into the hole site
2. Hang the panel into the screws and connect the power supply

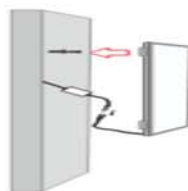
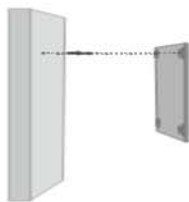

### CORRELATED COLOR TEMPERATURE CHART

3000K 4000K 5000K 6000K

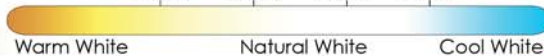

Warm White

Natural White

Cool White





## SYSTEM CONNECTION DIAGRAM

A. Wiring of the panel light with non-dimmable driver

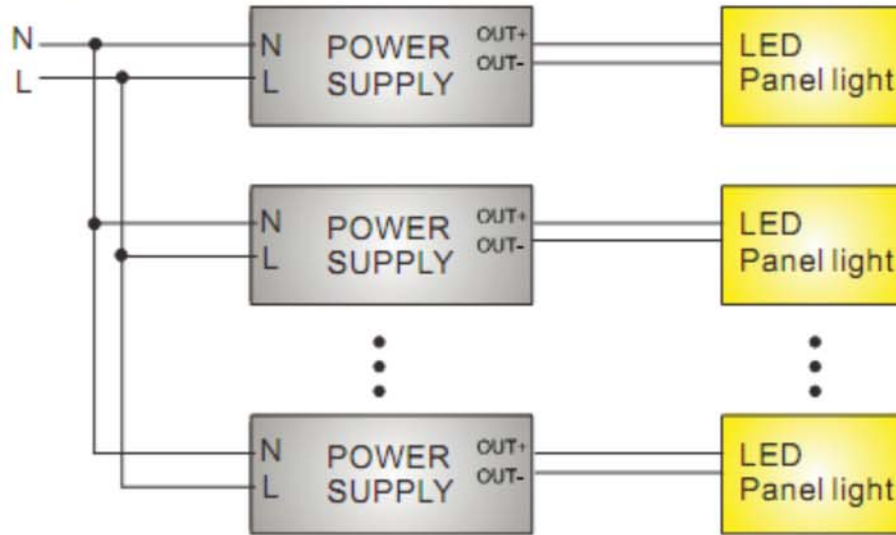

B. Wiring of the panel light with 0-10V dimmable driver

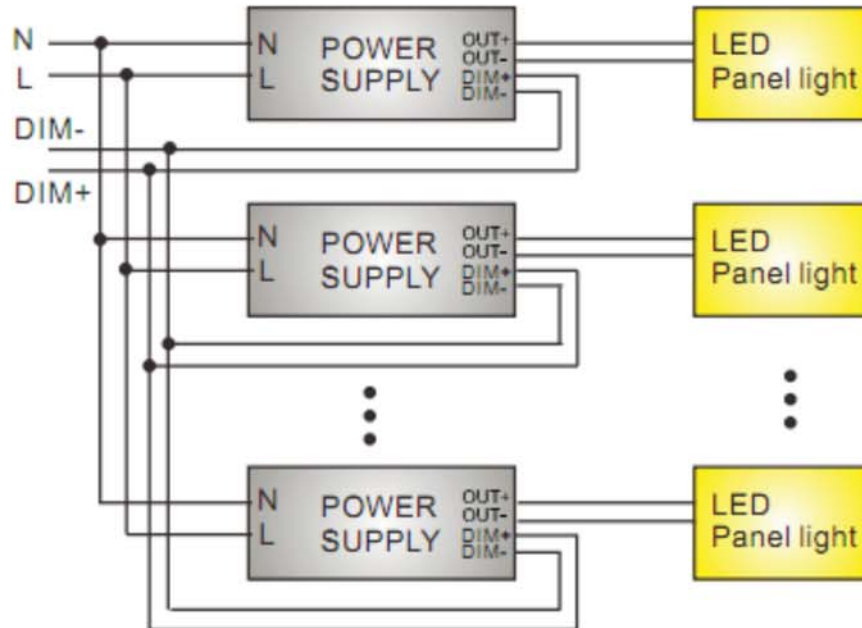

### CORRELATED COLOR TEMPERATURE CHART



# AIR GUARDIAN



## Enclosed UVC Disinfection Air Chamber

ANTI-VIRAL  
ANTI-MICROBIAL



### IMMACULIGHT 4-TIER PROTECTION:

1. Air enters TiO<sub>2</sub> ceramic filter inlet.
2. Air travels through proprietary coated chamber excited with UVA.
3. Air travels through >18 linear ft. chambers and >19 sq. ft. surface area excited with UVC.
4. Expelled air travels through carbon filter to catch leftover fine particulates.

### FEATURES:

- Protects human health without the use of harmful chemicals or materials. Heterogeneous filtration deodorizes and improves overall air quality by removing particulates, pathogens, and pollutants.
  - Emits No Ozone or chemical compounds; Multi-level filtration may help people in relieving symptoms of allergies to dust, mold, spores, and other allergens.
  - Fan and chamber work to kill airborne pathogens (including SARS-CoV-2, the virus that causes COVID-19), spores and any other living organism which passes through. Effective against MRSA, C. Difficile, Salmonella, E. Coli, and other pathogens.
  - Top tile-mounted Air Guardian™ pulls in air via surface-mounted fans. Air pulled into chamber is cleansed of airborne pathogens (viruses, molds, & bacteria) utilizing 260~265nm UVC with a >99% inactivation rate.\*
  - Total exposed surface area of TiO<sub>2</sub> (UVC disinfection) within Immaculight's Air Guardian™: >19 ft. Total length covered by air in Immaculight's Air Guardian™: >18 ft.
- Available in both 2' x 2' and 2' x 4' sizes.
- Aluminum Housing. Exhaust Kits available in multiple lengths: 8' | 12' | 24'

### APPLICATIONS:

Suitable for most commercial and institutional applications. May be placed in room, plenum or return duct. IoT available (Internet of Things)

- Office
- Retail
- Classrooms
- Healthcare Facilities
- Labs and Clinics

### CERTIFICATIONS:

- CE, ETL, RoHS
- Patent pending
- FDA Facility #10077990
- EPA Establishment # 98105-TX-1
- FDA Medical Device Classification Device Class 1 Listing #D420497

### WARRANTY:

- 405/470nm LED boards for downlight: 4 years
- 260~265nm LED boards in back chamber: 30,000 hrs
- Fans: 5 years
- Driver: 5 years
- Chamber Housing: 10 years

### WEIGHT:

- 2' x 2' = 10.65 lb
- 2' x 4' = 24 lb

**ERADICATE & REMOVE**  
>99% SARS-CoV-2, the virus causing  
**COVID-19**

Project: \_\_\_\_\_  
Location: \_\_\_\_\_  
Cat. #: \_\_\_\_\_  
Type: \_\_\_\_\_  
Quantity: \_\_\_\_\_



\* All viruses are known to be affected by UVC, however, inactivation time varies from virus to virus.

Est #: 98105-TX-1 | EPA Region: 06 | Co. #: 98105

(Rev. 10-20)

© 2020 IllumiPure Corp. reserves the right to change specifications without notice. Consult factory for most up to date specifications.



14340 Torrey Chase, Ste. 250 | Houston, Texas 77014  
Tel: 281-227-2208 | Visit us @ www.Immaculight.com



# AIR GUARDIAN



## Enclosed UVC Disinfection Air Chamber

ANTI-VIRAL  
ANTI-MICROBIAL

### SCHEMATICS:

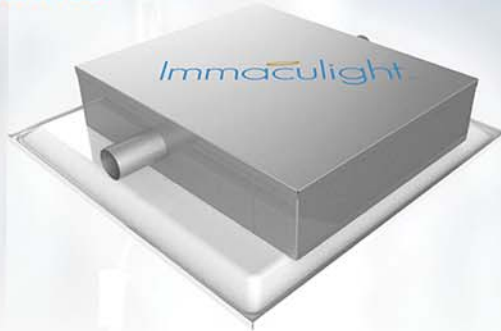

### SIDE VIEW:

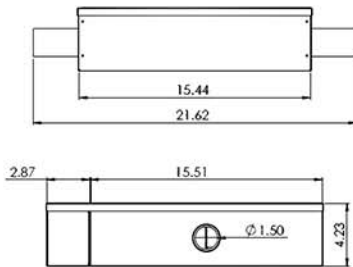

Total Flux	15.700	mW
FWHM viewing angle	130.00	deg
Distance	1.0000	in
On time	19.00	s
Optical Efficiency	100.00	%
Light source type	Point Source	
Simulation Surface Length	4.0000	in
Simulation Surface Width	1.0000	in
Number of fixtures	Go To Fixture Placement Tab	
Flux Unit	mW	
Energy Unit	mJ	
Area Unit	cm <sup>2</sup>	
Average irradiance of Array	0.3767	mW/cm <sup>2</sup>
Average dosage of Array	7.1572	mJ/cm <sup>2</sup>
Peak irradiance of Array	0.8624	mW/cm <sup>2</sup>
Peak dosage of Array	16.3853	mJ/cm <sup>2</sup>

1 UVC LED @ 1" OF 1 fin of 6 of 4 chambers  
Distance = 1", Height = 4", Width = 1"

### IRRADIANCE DISTRIBUTION

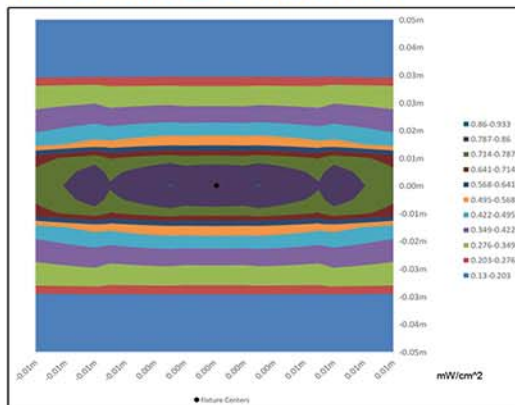

### SYSTEM SPECTRUM & IRRADIANCE RESULT

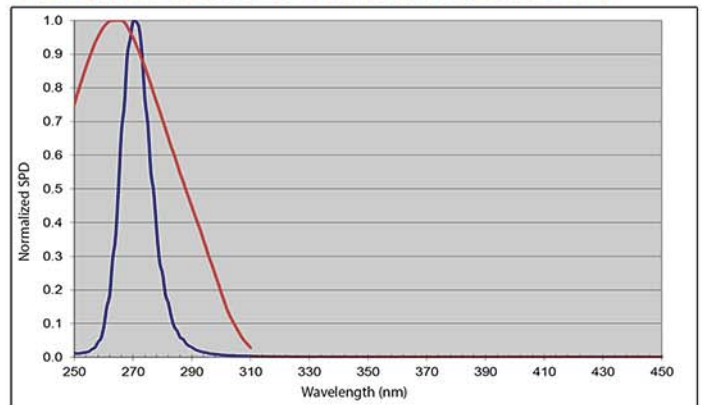

**ERADICATE & REMOVE**  
>99% SARS-CoV-2, the virus causing  
**COVID-19**



# Surface Purification Results

Wall Reflectance		90%		Irradiance		Min: 0.136, Max: 0.862		mW/cm <sup>2</sup>					
Simulate Chamber				Adjusted Irradiance		0.3767		mW/cm <sup>2</sup>					
				Time		19.000		s					
				Adjusted Dosage		6.267		mJ/cm <sup>2</sup>					
1st bounce contribution		41%		Time required for % reduction of original population				Target					
2nd bounce contribution		10%		% Reduction at system dosage		2 log (99%)		4 log (99.99%)					
						6 log (99.9999%)		80.00%					
<b>Bacteria</b>													
Acinetobacter baumannii <sup>6</sup>				99.4039%		17s		34s		51s		6s	
Bacillus anthracis - Anthrax <sup>1</sup>				97.9475%		23s		45s		1m 7s		8s	
Bacillus anthracis spores - Anthrax spores <sup>1</sup>				51.8957%		1m 59s		3m 59s		5m 58s		42s	
Bacillus magaterium sp. (spores) <sup>1</sup>				99.8499%		13s		27s		40s		5s	
Bacillus magaterium sp. (veg.) <sup>1</sup>				99.9999%		6s		13s		19s		2s	
Bacillus paratyphus <sup>1</sup>				99.6083%		16s		32s		47s		6s	
Bacillus subtilis spores <sup>1</sup>				78.4927%		57s		1m 53s		2m 50s		20s	
Bacillus subtilis <sup>1</sup>				95.3743%		28s		57s		1m 25s		10s	
Clostridium difficile <sup>5</sup>				78.4927%		57s		1m 53s		2m 50s		20s	
Corynebacterium diphtheriae <sup>1</sup>				99.4447%		17s		34s		51s		6s	
Ebertelia typhosa <sup>1</sup>				99.9738%		11s		21s		32s		4s	
Escherichia coli <sup>1,2</sup>				99.4039%		17s		34s		51s		6s	
Leptospiracanicola - infectious Jaundice <sup>1</sup>				99.6429%		16s		31s		47s		5s	
Micrococcus candidus <sup>1</sup>				93.5989%		32s		1m 3s		1m 35s		11s	
Micrococcus sphaeroides <sup>1</sup>				88.8685%		40s		1m 19s		1m 59s		14s	
Mycobacterium tuberculosis <sup>1</sup>				96.5983%		26s		52s		1m 17s		9s	
Neisseria catarrhalis <sup>1</sup>				98.1268%		22s		44s		1m 5s		8s	
Phytomonas tumefaciens <sup>1</sup>				98.5391%		21s		41s		1m 2s		7s	
Proteus vulgaris <sup>1,2</sup>				99.4039%		17s		34s		51s		6s	
Pseudomonas aeruginosa <sup>1,2</sup>				96.0041%		27s		54s		1m 21s		9s	
Pseudomonas fluorescens <sup>1</sup>				99.4039%		17s		34s		51s		6s	
Salmonella enteritidis <sup>1</sup>				98.8305%		20s		39s		59s		7s	
Salmonella paratyphi - Enteric fever <sup>1</sup>				99.6083%		16s		32s		47s		6s	
Salmonella typhosa - Typhoid fever <sup>1</sup>				99.9738%		11s		21s		32s		4s	
Salmonella typhimurium <sup>1</sup>				89.1855%		39s		1m 18s		1m 58s		14s	
Sarcina lutea <sup>1</sup>				72.2142%		1m 8s		2m 16s		3m 24s		24s	
Serratia marcescens <sup>1</sup>				99.5866%		16s		32s		48s		6s	
Shigella dysenteriae - Dysentery <sup>1</sup>				99.9681%		11s		22s		33s		4s	
Shigella flexneri - Dysentery <sup>1</sup>				99.9952%		9s		18s		26s		3s	
Shigella paradysenteriae <sup>1</sup>				99.9952%		9s		18s		26s		3s	
Spirillum rubrum <sup>1</sup>				99.5866%		16s		32s		48s		6s	
Staphylococcus albus <sup>1</sup>				99.7290%		15s		30s		44s		5s	
Staphylococcus aureus <sup>1,2</sup>				99.4039%		17s		34s		51s		6s	
Staphylococcus hemolyticus <sup>1</sup>				99.7860%		14s		28s		43s		5s	
Staphylococcus lactis <sup>1</sup>				97.8548%		23s		46s		1m 8s		8s	
Stenotrophomonas maltophilia <sup>1</sup>				97.2973%		24s		48s		1m 12s		8s	
Streptococcus viridans <sup>1</sup>				99.9863%		10s		20s		30s		3s	
Vibrio comma - Cholera <sup>1</sup>				99.4491%		17s		34s		50s		6s	
<b>Molds</b>													
Aspergillus flavus <sup>1</sup>				28.9301%		4m 16s		8m 32s		12m 48s		1m 29s	
Aspergillus glaucus <sup>1</sup>				31.9001%		3m 47s		7m 35s		11m 23s		1m 19s	
Aspergillus niger <sup>1</sup>				9.7378%		14m 14s		28m 28s		42m 42s		4m 58s	
Mucor racemosus A <sup>1</sup>				61.7293%		1m 31s		3m 2s		4m 33s		32s	
Mucor racemosus B <sup>1</sup>				61.7293%		1m 31s		3m 2s		4m 33s		32s	
Oospora lactis <sup>1</sup>				95.3743%		28s		57s		1m 25s		10s	
Penicillium expansum <sup>1</sup>				78.4927%		57s		1m 53s		2m 50s		20s	
Penicillium roqueforti <sup>1</sup>				72.2142%		1m 8s		2m 16s		3m 24s		24s	
Penicillium digitatum <sup>1</sup>				31.9001%		3m 47s		7m 35s		11m 23s		1m 19s	
Rhisopus nigricans <sup>1</sup>				14.2452%		9m 29s		18m 58s		28m 28s		3m 18s	
<b>Protozoa</b>													
Chlorella Vulgaris <sup>1</sup>				78.4927%		57s		1m 53s		2m 50s		20s	
Nematode Eggs <sup>1</sup>				30.7530%		3m 58s		7m 56s		11m 54s		1m 23s	
Paramecium <sup>1</sup>				81.5564%		52s		1m 43s		2m 35s		18s	
<b>Virus</b>													
Bacteriophage - E. Coli (MS2) <sup>1</sup>				99.4039%		17s		34s		51s		6s	
Coronavirus (SARS-CoV-2) <sup>4</sup>				99.8843%		13s		26s		39s		5s	
Infectious Hepatitis <sup>1</sup>				98.5391%		21s		41s		1m 2s		7s	
Influenza <sup>1</sup>				99.4039%		17s		34s		51s		6s	
Poliovirus - Poliomyelitis <sup>1</sup>				99.4039%		17s		34s		51s		6s	
Tobacco mosaic <sup>1</sup>				7.3961%		18m 58s		37m 57s		56m 56s		6m 37s	
<b>Yeast</b>													
Brewers yeast <sup>1</sup>				99.4039%		17s		34s		51s		6s	
Candida albicans <sup>3</sup>				92.9981%		33s		1m 5s		1m 38s		12s	
Common yeast cake <sup>1</sup>				92.2795%		34s		1m 8s		1m 42s		12s	
Saccharomyces carevisiae <sup>1</sup>				92.2795%		34s		1m 8s		1m 42s		12s	
Saccharomyces ellipsoideus <sup>1</sup>				92.2795%		34s		1m 8s		1m 42s		12s	
Saccharomyces spores <sup>1,2</sup>				85.3535%		46s		1m 31s		2m 16s		16s	